

# Powertrain Systems

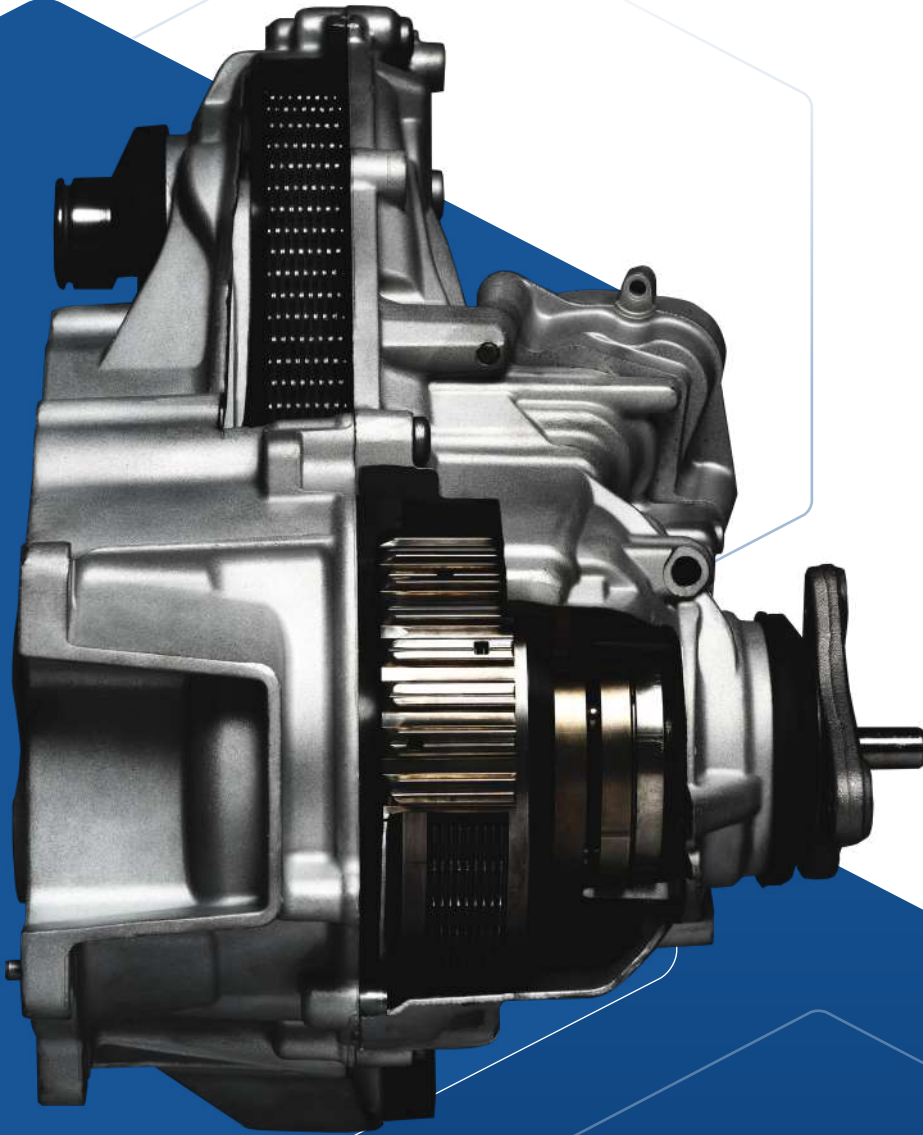

**s-Tec**  
Service Technologies

Alle in diesem Katalog angeführten Produkte passen genau zu den Fahrzeugen, bei denen sie angeführt sind. Die Verwendung von Marken und Modellbezeichnungen in diesem Katalog dient ausschließlich dem Zweck, das Fahrzeugmodell zu identifizieren, in das unsere Teile eingebaut werden können. Bei unsachgemäßem Einbau unserer Waren wird keine Haftung übernommen. Abbildungen unverbindlich, technische Änderungen vorbehalten. Handelsnamen von Fahrzeugmodellen und Herstellern werden in diesem Katalog nur in einer identifizierenden Funktion verwendet. Alle Abbildungen sind Eigentum der Service Technologies GmbH & Co OG und Service Technologies GmbH. Jeder Person oder Firma ist die Verwendung der Abbildungen ohne schriftliche Genehmigung von Service Technologies GmbH & Co OG und Service Technologies GmbH verboten. Alle Rechte vorbehalten. Diese Publikation darf weder ganz noch teilweise in irgendeiner Form ohne eine schriftliche Genehmigung der Service Technologies GmbH & Co OG und Service Technologies GmbH vervielfältigt werden. Änderungen ohne Ankündigung vorbehalten. Alle Angaben sind unverbindlich und ohne Gewähr sowie vorbehaltlich für Satz- und Druckfehler. Für Irrtümer und Druckfehler keine Haftung.

#### **Wichtiger Hinweis**

Für unbelüftete Tankverschlüsse ist in jedem Fall zu prüfen, ob der Tank eine Belüftung hat. Bei Nichtbeachtung werden Tank- bzw. Anzeigergeräte beschädigt, wofür der Hersteller jegliche Haftung ablehnt. Wurde bei Ihrem Fahrzeug der Serientank geändert oder getauscht, so ist darauf zu achten, dass der verwendete Tankverschluss in Funktion und Ausführung den Tankanforderungen entspricht. Alle Maßangaben in mm ohne Berücksichtigung von Toleranzen.

*All products mentioned in this catalogue precisely fit into the vehicles for which they are mentioned. The use of brands and model names in this catalogue purely serves the purpose of identifying the vehicle model into which our parts can be fitted. No liability is accepted for improper fitting of our products. Illustrations are non-binding, subject to technical amendments. Trade names of vehicle models and manufacturers are used in this catalogue only in an identifying capacity. All illustrations are the property of Service Technologies GmbH & Co OG and Service Technologies GmbH. Use of the illustrations by any person or company without the written permission of Service Technologies GmbH & Co OG and Service Technologies GmbH is prohibited. All rights reserved. This publication may not be reproduced either in whole or in part in any form whatsoever without the written permission of Service Technologies GmbH & Co OG and Service Technologies GmbH. Subject to amendments without notice. All particulars are non-binding and without engagement and subject to typographical and printing errors. No liability for errors and printing errors.*

#### **Important note**

*In the case of non-ventilated tank closures, a check must always be made to determine whether the tank has ventilation. Failure to comply with this will result in damage to tank equipment and gauges, for which the manufacturer refuses to accept liability. If the standard tank has been altered or replaced in your vehicle, you should ensure that the tank closure used complies with the tank requirements in terms of function and design. All dimensions in mm with no allowance made for tolerances.*

# Inhalt

## Content

<b>Unternehmen / Company</b>	<b>4</b>
<b>4WD Systems</b>	<b>8</b>
<b>Brand</b>	
Audi	8
BMW	27
Chrysler	71
Dodge	72
Fiat	73
Hyundai	74
Infiniti	75
Jaguar	76
Land Rover	77
Maserati	83
Mercedes-Benz	84
Nissan	107
Porsche	108
Seat	113
Skoda	114
VW	118
<b>Abbreviations</b>	<b>149</b>
<b>Service Bulletins</b>	<b>150</b>
<b>Oil List</b>	<b>152</b>
<b>References</b>	<b>187</b>



**Immer am neuesten Stand:**

Einfach QR-Code scannen und online die aktuellste Version unserer Kataloge abrufen.

**Always up to date:**

Simply scan the QR code to view the latest version of our catalogues online.





**s-Tec**  
Service Technologies



■ ■ ■ GETRAG

**WEHRLE M**



## Wir sind der weltweite Service- und Vertriebspartner von Ersatzteilen sowie Aufbereiter für alle namhaften Automarken.

S-TEC hat sich als Aftermarket-Experte mit einem breiten Fahrzeug-Ersatzteilportfolio international etabliert und steht für verlässliche Vertriebs- und Serviceleistungen auf OEM-Niveau.

### Wir bieten

Antriebsstrang-Systeme  
Body Parts  
Tanksysteme  
Elektronikkomponenten  
Offroad Components  
Service / Werkstatt  
Puch G / Pinzgauer Ersatzteile

Im Sinne einer effizienten Mobilität von morgen leben wir Präzision und Qualitätsbewusstsein für Perfektion bis ins letzte Detail. Wir sind der Auffassung, dass sich ein modernes Unternehmen nicht nur durch die Qualität seiner Produkte, sondern auch durch seine Unternehmenskultur auszeichnet, die von der Kooperationsbereitschaft und dem Verantwortungsbewusstsein jeder einzelnen Mitarbeiterin und jedes einzelnen Mitarbeiters getragen wird. S-TEC wurde 2006 inmitten des österreichischen Automobil-Clusters gegründet und ist seither mit unterschiedlichen Produktgruppen und Marken in verschiedenen Kundensegmenten tätig.

Marken wie GETRAG, BLAU, WEHRLE und PUCH sind in der Automobilwelt seit Jahrzehnten ein Begriff für Flexibilität, Innovationskraft und Qualität. Diese Werte werden aber auch von den anderen Bereichen und Marken innerhalb der S-TEC als Kernkompetenzen des Unternehmens angesehen.

## We are the worldwide service and sales partner for spare parts and remanufacturer for all well-known car brands.

*As aftermarket expert with a large automotive spare parts portfolio, S-TEC has established itself internationally and earned a reputation for reliable distribution and maintenance services to OEM standards.*

### We offer

Powertrain Systems  
Body Parts  
Fuel Systems  
Electronic Systems  
Offroad Components  
Services / Workshops  
Puch G / Pinzgauer Parts

*We set the agenda for the efficient mobility of the future with an uncompromising commitment to quality combined with perfection down to the last detail. We believe that a modern business/management/company is not only determined by the quality of its products but also by its managerial culture that is the result of commitment and sense of responsibility of every single employee. S-TEC was founded in 2006 in the middle of the Austrian Automobile-Cluster and has been operating since then with different product groups and brands in different customer segments.*

*In the automotive world, brands such as GETRAG, BLAU, WEHRLE and PUCH have been known for unique flexibility, innovation and quality for decades. These values are also seen as core competencies by the other divisions and brands within S-TEC.*



Independent Aftermarket

## POWERTRAIN SYSTEMS

Aufbereitete Verteilergetriebe / *Remanufactured Transfer Cases*

Aufbereitete Vorder- und Hinterachsdifferentiale /  
*Remanufactured Front and Rear Axle Drives*

Reparatursätze und Einzelteile / *Repair Kits and Single Parts*

Öl / *Oil*

s-tec.at

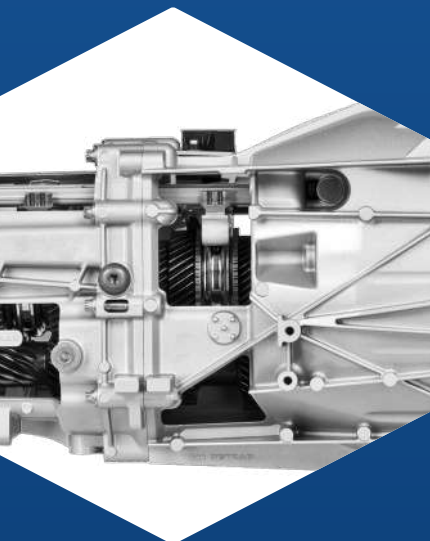

■■■ GETRAG

Independent Aftermarket

## TRANSMISSION SYSTEMS

Aufbereitete Schaltgetriebe / *Remanufactured Manual Transmissions*

Aufbereitete automatisierte Schaltgetriebe /  
*Remanufactured Automated Transmissions*

Aufbereitete Doppelkupplungsgetriebe /  
*Remanufactured Double Clutch Transmissions*

Kupplungen und Mechatroniken / *Clutches and Control Units*

Reparatursätze und Einzelteile / *Repair Kits and Single Parts*

Öl / *Oil*

s-tec.at



Independent Aftermarket

## BODY PARTS

Aufprallträger / *Impact Beams*

Stoßfänger / *Bumper Beams*

Außenspiegel / *Outside Mirror*

Beleuchtung / *Lightning*

Reflektoren / *Reflectors*

Scheinwerfer / *Head Lamps*

s-tec.at



Independent Aftermarket & Industry

## FUEL SYSTEMS

Tankverschlüsse / *Fuel Caps*  
Kühlerverschlüsse / *Radiator Caps*  
Ölverschlüsse / *Oil Caps*  
Füllsysteme / *Filling Systems*

[blau.co.at](http://blau.co.at)



Independent Aftermarket & Industry

## AUTOMOTIVE ELECTRONICS

Relais / *Relays*  
Blinkgeber / *Flasher Units*  
Glühzeitsteuergeräte / *Glow Plug Control Units*

[wehrle-electronics.at](http://wehrle-electronics.at)



Offroad Competence Center

## PUCH G / PINZGAUER

Ersatzteile und Zubehör / *Spare Parts and Accessories*  
Gebrauchtfahrzeuge / *Used Vehicles*  
Fachwerkstätte / *Workshop*  
Hutchinson Felgen / *Hutchinson Wheels*  
Jagd- und Reisezubehör / *Hunting and Travel Equipment*

[puch.at](http://puch.at)

### Brand - Series - Sales Name

### Maingroup - Subgroup

Salesname	Model	kW/HP	Model Year	Gearbox	Part Number	OEM Number	Info	Image
-----------	-------	-------	------------	---------	-------------	------------	------	-------

### Audi - A3 - A3 (8P1)



Img.1

### Front Axle, Steering Unit - Power take off (PTO)

A3 (8P1)	1.8 TFSI quattro	118/160	2008/07-2012/08	6MT	FD00052-RI	0AV409053AE		1
A3 (8P1)	2.0 TDI 16V quattro	103/140	2004/08-2012/08	6AT	FD00053-RI	0AV409053AF		1
A3 (8P1)	2.0 TDI 16V quattro	103/140	2004/08-2012/08	6MT	FD00052-RI	0AV409053AE		1
A3 (8P1)	2.0 TDI quattro	100/136	2003/05-2008/06	6MT	FD00052-RI	0AV409053AE		1
A3 (8P1)	2.0 TDI quattro	100/136	2003/05-2008/06	6AT	FD00053-RI	0AV409053AF		1
A3 (8P1)	2.0 TDI quattro	103/140	2006/01-2008/06	6MT	FD00052-RI	0AV409053AE		1
A3 (8P1)	2.0 TDI quattro	103/140	2006/01-2008/06	6AT	FD00053-RI	0AV409053AF		1
A3 (8P1)	2.0 TDI quattro	125/170	2006/03-2012/08	6MT	FD00052-RI	0AV409053AE		1
A3 (8P1)	2.0 TDI quattro	125/170	2006/03-2012/08	6AT	FD00053-RI	0AV409053AF		1
A3 (8P1)	2.0 TDI	125/170	2006/03-2012/08		FD00052-RI	0AV409053AE		1
A3 (8P1)	2.0 TFSI quattro	147/200	2004/09-2012/08	6MT	FD00052-RI	0AV409053AE		1
A3 (8P1)	2.0 TFSI quattro	147/200	2004/09-2012/08	6AT	FD00053-RI	0AV409053AF		1
A3 (8P1)	3.2 V6 quattro	184/250	2003/07-2009/05	6MT	FD00052-RI	0AV409053AE		1
A3 (8P1)	3.2 V6 quattro	184/250	2003/07-2009/05	6AT	FD00053-RI	0AV409053AF		1
A3 (8P1)	3.2 quattro	186/253	2005/09-2009/12	6MT	FD00052-RI	0AV409053AE		1
A3 (8P1)	3.2 quattro	186/253	2005/09-2009/12	6AT	FD00053-RI	0AV409053AF		1
A3 (8P1)	S3 quattro	188/256	2007/02-2012/08	6AT	FD00053-RI	0AV409053AF		1
A3 (8P1)	S3 quattro	188/256	2007/02-2012/08	6MT	FD00052-RI	0AV409053AE		1
A3 (8P1)	S3 quattro	195/265	2006/11-2012/08	6AT	FD00053-RI	0AV409053AF		1
A3 (8P1)	S3 quattro	195/265	2006/11-2012/08	6MT	FD00052-RI	0AV409053AE		1



Img.1



Img.2

### Rear Axle - Rear Differential

A3 (8P1)	1.8 TFSI quattro	118/160	2008/07-2012/08	7AT	RD00059-RI	0BR525010G		1
A3 (8P1)	1.8 TFSI quattro	118/160	2008/07-2012/08	6MT	RD00059-RI	0BR525010G		1
A3 (8P1)	2.0 TDI 16V quattro	103/140	2004/08-2012/08	6AT	RD00023-RI	0AV525010L		2
A3 (8P1)	2.0 TDI 16V quattro	103/140	2004/08-2012/08	6MT	RD00023-RI	0AV525010L		2
A3 (8P1)	2.0 TDI quattro	100/136	2003/05-2008/06	6MT	RD00023-RI	0AV525010L		2
A3 (8P1)	2.0 TDI quattro	100/136	2003/05-2008/06	6AT	RD00023-RI	0AV525010L		2
A3 (8P1)	2.0 TDI quattro	103/140	2006/01-2008/06	6MT	RD00023-RI	0AV525010L		2
A3 (8P1)	2.0 TDI quattro	103/140	2006/01-2008/06	6AT	RD00023-RI	0AV525010L		2
A3 (8P1)	2.0 TDI quattro	125/170	2006/03-2008/06	6MT	RD00023-RI	0AV525010L		2
A3 (8P1)	2.0 TDI quattro	125/170	2008/06-2012/08	6MT	RD00059-RI	0BR525010G		1
A3 (8P1)	2.0 TDI quattro	125/170	2008/06-2012/08	6AT	RD00023-RI	0AV525010L		2
A3 (8P1)	2.0 TDI quattro	125/170	2008/06-2012/08	6AT	RD00059-RI	0BR525010G		1
A3 (8P1)	2.0 TDI	125/170	2006/03-2012/08		RD00059-RI	0BR525010G		1

All rights reserved.

This publication may not be reproduced in any form, in whole or in part, without a written approval from S-TEC Service Technologies GmbH & Co OG.  
Subject to change without notice!



### Brand - Series - Sales Name

### Maingroup - Subgroup

Salesname	Model	kW/HP	Model Year	Gearbox	Part Number	OEM Number	Info	Image
-----------	-------	-------	------------	---------	-------------	------------	------	-------

### Audi - A3 - A3 (8P1)

#### Rear Axle - Rear Differential

A3 (8P1)	2.0 TFSI quattro	147/200	2004/09-2008/06	6MT	RD00022-RI	0AV525010K		2
A3 (8P1)	2.0 TFSI quattro	147/200	2004/09-2008/06	6AT	RD00022-RI	0AV525010K		2
A3 (8P1)	2.0 TFSI quattro	147/200	2008/07-2012/08	6AT	RD00059-RI	0BR525010G		1
A3 (8P1)	2.0 TFSI quattro	147/200	2008/07-2012/08	6MT	RD00059-RI	0BR525010G		1
A3 (8P1)	3.2 V6 quattro	184/250	2003/07-2008/06	6AT	RD00022-RI	0AV525010K		2
A3 (8P1)	3.2 V6 quattro	184/250	2003/07-2008/06	6MT	RD00022-RI	0AV525010K		2
A3 (8P1)	3.2 V6 quattro	184/250	2008/07-2009/05	6AT	RD00059-RI	0BR525010G		1
A3 (8P1)	3.2 V6 quattro	184/250	2008/07-2009/05	6MT	RD00059-RI	0BR525010G		1
A3 (8P1)	3.2 quattro	186/253	2005/09-2008/06	6MT	RD00022-RI	0AV525010K		2
A3 (8P1)	3.2 quattro	186/253	2005/09-2008/06	6AT	RD00022-RI	0AV525010K		2
A3 (8P1)	3.2 quattro	186/253	2008/07-2009/12	6MT	RD00059-RI	0BR525010G		1
A3 (8P1)	3.2 quattro	186/253	2008/07-2009/12	6AT	RD00059-RI	0BR525010G		1
A3 (8P1)	S3 quattro	188/256	2007/02-2008/06	6AT	RD00022-RI	0AV525010K		2
A3 (8P1)	S3 quattro	188/256	2007/02-2008/06	6MT	RD00022-RI	0AV525010K		2
A3 (8P1)	S3 quattro	188/256	2008/07-2012/08	6MT	RD00059-RI	0BR525010G		1
A3 (8P1)	S3 quattro	188/256	2008/07-2012/08	6AT	RD00059-RI	0BR525010G		1
A3 (8P1)	S3 quattro	195/265	2006/11-2008/06	6MT	RD00022-RI	0AV525010K		2
A3 (8P1)	S3 quattro	195/265	2006/11-2012/08	6AT	RD00059-RI	0BR525010G		1
A3 (8P1)	S3 quattro	195/265	2008/07-2012/08	6MT	RD00059-RI	0BR525010G		1
A3 (8P1)	S3 quattro	195/265	2008/07-2012/08	6AT	RD00022-RI	0AV525010K		2

All rights reserved.

This publication may not be reproduced in any form, in whole or in part, without a written approval from S-TEC Service Technologies GmbH & Co OG.  
Subject to change without notice!

### Brand - Series - Sales Name

### Maingroup - Subgroup

Salesname	Model	kW/HP	Model Year	Gearbox	Part Number	OEM Number	Info	Image
-----------	-------	-------	------------	---------	-------------	------------	------	-------

### Audi - A3 - A3 Sportback (8PA)



Img.1



Img.2

### Front Axle, Steering Unit - Power take off (PTO)

A3 Sportback (8PA)	1.8 TFSI quattro	118/160	2008/07-2013/03	6MT	FD00052-RI	0AV409053AE		1
A3 Sportback (8PA)	2.0 TDI 16V quattro	103/140	2005/11-2013/03	6MT	FD00052-RI	0AV409053AE		1
A3 Sportback (8PA)	2.0 TDI 16V quattro	103/140	2005/11-2013/03	6AT	FD00053-RI	0AV409053AF		1
A3 Sportback (8PA)	2.0 TDI quattro	103/140	2006/01-2008/06	6AT	FD00053-RI	0AV409053AF		1
A3 Sportback (8PA)	2.0 TDI quattro	103/140	2006/01-2008/06	6MT	FD00052-RI	0AV409053AE		1
A3 Sportback (8PA)	2.0 TDI quattro	125/170	2006/03-2013/03	6MT	FD00052-RI	0AV409053AE		1
A3 Sportback (8PA)	2.0 TDI quattro	125/170	2006/03-2013/03	6AT	FD00053-RI	0AV409053AF		1
A3 Sportback (8PA)	2.0 TFSI quattro	147/200	2004/09-2013/03	6MT	FD00052-RI	0AV409053AE		1
A3 Sportback (8PA)	2.0 TFSI quattro	147/200	2004/09-2013/03	6AT	FD00053-RI	0AV409053AF		1
A3 Sportback (8PA)	3.2 V6 quattro	184/250	2004/09-2009/05	6MT	FD00052-RI	0AV409053AE		1
A3 Sportback (8PA)	3.2 V6 quattro	184/250	2004/09-2009/05	6AT	FD00053-RI	0AV409053AF		1
A3 Sportback (8PA)	RS3 quattro	250/340	2011/01-2012/12		FD00060-RI	0A6409053AH		2
A3 Sportback (8PA)	S3 quattro	188/256	2008/07-2013/03	6AT	FD00053-RI	0AV409053AF		1
A3 Sportback (8PA)	S3 quattro	188/256	2008/07-2013/03	6MT	FD00052-RI	0AV409053AE		1
A3 Sportback (8PA)	S3 quattro	195/265	2008/06-2013/03	6MT	FD00052-RI	0AV409053AE		1
A3 Sportback (8PA)	S3 quattro	195/265	2008/06-2013/03	6AT	FD00053-RI	0AV409053AF		1



Img.1



Img.2

### Rear Axle - Rear Differential

A3 Sportback (8PA)	1.8 TFSI quattro	118/160	2008/07-2013/03	6MT	RD00059-RI	0BR525010G		1
A3 Sportback (8PA)	1.8 TFSI quattro	118/160	2008/07-2013/03	7AT	RD00059-RI	0BR525010G		1
A3 Sportback (8PA)	2.0 TDI 16V quattro	103/140	2005/11-2013/03	6AT	RD00023-RI	0AV525010L		2
A3 Sportback (8PA)	2.0 TDI 16V quattro	103/140	2005/11-2013/03	6MT	RD00023-RI	0AV525010L		2
A3 Sportback (8PA)	2.0 TDI quattro	103/140	2006/01-2008/06	6AT	RD00023-RI	0AV525010L		2
A3 Sportback (8PA)	2.0 TDI quattro	103/140	2006/01-2008/06	6MT	RD00023-RI	0AV525010L		2
A3 Sportback (8PA)	2.0 TDI quattro	125/170	2006/03-2008/06	6MT	RD00023-RI	0AV525010L		2

All rights reserved.

This publication may not be reproduced in any form, in whole or in part, without a written approval from S-TEC Service Technologies GmbH & Co OG.  
Subject to change without notice!

### Brand - Series - Sales Name

### Maingroup - Subgroup

Salesname	Model	kW/HP	Model Year	Gearbox	Part Number	OEM Number	Info	Image
-----------	-------	-------	------------	---------	-------------	------------	------	-------

### Audi - A3 - A3 Sportback (8PA)

#### Rear Axle - Rear Differential

A3 Sportback (8PA)	2.0 TDI quattro	125/170	2006/03-2008/06	6AT	RD00023-RI	0AV525010L		2
A3 Sportback (8PA)	2.0 TDI quattro	125/170	2008/07-2013/03	6AT	RD00059-RI	0BR525010G		1
A3 Sportback (8PA)	2.0 TDI quattro	125/170	2008/07-2013/03	6MT	RD00059-RI	0BR525010G		1
A3 Sportback (8PA)	2.0 TFSI quattro	147/200	2004/09-2008/06	6AT	RD00022-RI	0AV525010K		2
A3 Sportback (8PA)	2.0 TFSI quattro	147/200	2004/09-2008/06	6MT	RD00022-RI	0AV525010K		2
A3 Sportback (8PA)	2.0 TFSI quattro	147/200	2004/09-2013/03	6MT	RD00059-RI	0BR525010G		1
A3 Sportback (8PA)	2.0 TFSI quattro	147/200	2008/07-2013/03	6AT	RD00059-RI	0BR525010G		1
A3 Sportback (8PA)	3.2 V6 quattro	184/250	2004/09-2009/05	6MT	RD00022-RI	0AV525010K		2
A3 Sportback (8PA)	3.2 V6 quattro	184/250	2004/09-2009/05	6AT	RD00022-RI	0AV525010K		2
A3 Sportback (8PA)	RS3 quattro	250/340	2011/01-2012/12	7AT	RD00059-RI	0BR525010G		1
A3 Sportback (8PA)	S3 quattro	188/256	2008/07-2013/03	6MT	RD00059-RI	0BR525010G		1
A3 Sportback (8PA)	S3 quattro	188/256	2008/07-2013/03	6AT	RD00059-RI	0BR525010G		1
A3 Sportback (8PA)	S3 quattro	195/265	2008/06-2013/03	6AT	RD00059-RI	0BR525010G		1
A3 Sportback (8PA)	S3 quattro	195/265	2008/06-2013/03	6MT	RD00059-RI	0BR525010G		1

All rights reserved.

This publication may not be reproduced in any form, in whole or in part, without a written approval from S-TEC Service Technologies GmbH & Co OG.  
Subject to change without notice!

## Brand - Series - Sales Name

### Maingroup - Subgroup

Salesname	Model	kW/HP	Model Year	Gearbox	Part Number	OEM Number	Info	Image
-----------	-------	-------	------------	---------	-------------	------------	------	-------

## Audi - A4 - A4 (8K2, B8)



Img.1

### Rear Axle - Rear Differential

A4 (8K2, B8)	3.0 TDI quattro	171/233	2009/09-2015/12	7AT	RD00008-RI	0BF500043Q	No complete unit, only single parts available! For details please see 4WD Single Parts catalogue.	1
A4 (8K2, B8)	3.0 TDI quattro	176/240	2009/09-2012/03	7AT	RD00008-RI	0BF500043Q	No complete unit, only single parts available! For details please see 4WD Single Parts catalogue.	1
A4 (8K2, B8)	3.0 TDI quattro	180/245	2011/11-2015/12	7AT	RD00008-RI	0BF500043Q	No complete unit, only single parts available! For details please see 4WD Single Parts catalogue.	1
A4 (8K2, B8)	3.0 TFSI quattro	200/272	2012/02-2015/12	7AT	RD00008-RI	0BF500043Q	No complete unit, only single parts available! For details please see 4WD Single Parts catalogue.	1
A4 (8K2, B8)	S4 quattro	245/333	2009/09-2015/12	7AT	RD00008-RI	0BF500043Q	No complete unit, only single parts available! For details please see 4WD Single Parts catalogue.	1

## Audi - A4 - A4 Allroad (8KH, B8)



Img.1

### Rear Axle - Rear Differential

A4 Allroad (8KH, B8)	3.0 TDI quattro	176/240	2009/09-2012/01	7AT	RD00008-RI	0BF500043Q	No complete unit, only single parts available! For details please see 4WD Single Parts catalogue.	1
A4 Allroad (8KH, B8)	3.0 TDI quattro	180/245	2012/01-2016/05	7AT	RD00008-RI	0BF500043Q	No complete unit, only single parts available! For details please see 4WD Single Parts catalogue.	1

All rights reserved.

This publication may not be reproduced in any form, in whole or in part, without a written approval from S-TEC Service Technologies GmbH & Co OG.  
Subject to change without notice!

### Brand - Series - Sales Name

### Maingroup - Subgroup

Salesname	Model	kW/HP	Model Year	Gearbox	Part Number	OEM Number	Info	Image
-----------	-------	-------	------------	---------	-------------	------------	------	-------

### Audi - A4 - A4 Avant (8K5, B8)



Img.1

### Rear Axle - Rear Differential

A4 Avant (8K5, B8)	3.0 TDI quattro	176/240	2009/09-2012/03	7AT	RD00008-RI	0BF500043Q	No complete unit, only single parts available! For details please see 4WD Single Parts catalogue.	1
A4 Avant (8K5, B8)	3.0 TDI quattro	180/245	2011/11-2015/12	7AT	RD00008-RI	0BF500043Q	No complete unit, only single parts available! For details please see 4WD Single Parts catalogue.	1
A4 Avant (8K5, B8)	3.0 TFSI quattro	200/272	2012/02-2015/12	7AT	RD00008-RI	0BF500043Q	No complete unit, only single parts available! For details please see 4WD Single Parts catalogue.	1
A4 Avant (8K5, B8)	S4 quattro	245/333	2009/09-2015/12	7AT	RD00008-RI	0BF500043Q	No complete unit, only single parts available! For details please see 4WD Single Parts catalogue.	1

All rights reserved.

This publication may not be reproduced in any form, in whole or in part, without a written approval from S-TEC Service Technologies GmbH & Co OG.  
Subject to change without notice!

### Brand - Series - Sales Name

### Maingroup - Subgroup

Salesname	Model	kW/HP	Model Year	Gearbox	Part Number	OEM Number	Info	Image
-----------	-------	-------	------------	---------	-------------	------------	------	-------

### Audi - A5 - A5 (8T3)



Img.1

### Rear Axle - Rear Differential

A5 (8T3)	3.0 TDI quattro	160/218	2015/05-2017/01	7AT	RD00008-RI	0BF500043Q	No complete unit, only single parts available! For details please see 4WD Single Parts catalogue.	1
A5 (8T3)	3.0 TDI quattro	176/240	2009/09-2012/03	7AT	RD00008-RI	0BF500043Q	No complete unit, only single parts available! For details please see 4WD Single Parts catalogue.	1
A5 (8T3)	3.0 TDI quattro	180/245	2011/10-2017/01	7AT	RD00008-RI	0BF500043Q	No complete unit, only single parts available! For details please see 4WD Single Parts catalogue.	1
A5 (8T3)	3.0 TFSI quattro	200/272	2011/12-2017/01	7AT	RD00008-RI	0BF500043Q	No complete unit, only single parts available! For details please see 4WD Single Parts catalogue.	1
A5 (8T3)	S5 quattro	245/333	2011/10-2017/01	7AT	RD00008-RI	0BF500043Q	No complete unit, only single parts available! For details please see 4WD Single Parts catalogue.	1
A5 (8T3)	S5 quattro	249/339	2013/01-2017/01	7AT	RD00008-RI	0BF500043Q	No complete unit, only single parts available! For details please see 4WD Single Parts catalogue.	1

All rights reserved.

This publication may not be reproduced in any form, in whole or in part, without a written approval from S-TEC Service Technologies GmbH & Co OG.  
Subject to change without notice!

### Brand - Series - Sales Name

### Maingroup - Subgroup

Salesname	Model	kW/HP	Model Year	Gearbox	Part Number	OEM Number	Info	Image
-----------	-------	-------	------------	---------	-------------	------------	------	-------

### Audi - A5 - A5 Cabriolet (8F7)



Img.1

### Rear Axle - Rear Differential

A5 Cabriolet (8F7)	3.0 TDI quattro	160/218	2015/05-2017/01	7AT	RD00008-RI	0BF500043Q	No complete unit, only single parts available! For details please see 4WD Single Parts catalogue.	1
A5 Cabriolet (8F7)	3.0 TDI quattro	176/240	2009/07-2012/03	7AT	RD00008-RI	0BF500043Q	No complete unit, only single parts available! For details please see 4WD Single Parts catalogue.	1
A5 Cabriolet (8F7)	3.0 TDI quattro	180/245	2011/10-2017/01	7AT	RD00008-RI	0BF500043Q	No complete unit, only single parts available! For details please see 4WD Single Parts catalogue.	1
A5 Cabriolet (8F7)	3.0 TFSI quattro	200/272	2011/11-2017/01	7AT	RD00008-RI	0BF500043Q	No complete unit, only single parts available! For details please see 4WD Single Parts catalogue.	1
A5 Cabriolet (8F7)	S5 quattro	245/333	2009/07-2017/01	7AT	RD00008-RI	0BF500043Q	No complete unit, only single parts available! For details please see 4WD Single Parts catalogue.	1

All rights reserved.

This publication may not be reproduced in any form, in whole or in part, without a written approval from S-TEC Service Technologies GmbH & Co OG.  
Subject to change without notice!

## Brand - Series - Sales Name

### Maingroup - Subgroup

Salesname	Model	kW/HP	Model Year	Gearbox	Part Number	OEM Number	Info	Image
-----------	-------	-------	------------	---------	-------------	------------	------	-------

## Audi - A5 - A5 Sportback (8TA)



Img.1

### Rear Axle - Rear Differential

A5 Sportback (8TA)	3.0 TDI quattro	160/218	2015/05-2017/01	7AT	RD00008-RI	0BF500043Q	No complete unit, only single parts available! For details please see 4WD Single Parts catalogue.	1
A5 Sportback (8TA)	3.0 TDI quattro	176/240	2009/09-2012/03	7AT	RD00008-RI	0BF500043Q	No complete unit, only single parts available! For details please see 4WD Single Parts catalogue.	1
A5 Sportback (8TA)	3.0 TDI quattro	180/245	2011/10-2017/01	7AT	RD00008-RI	0BF500043Q	No complete unit, only single parts available! For details please see 4WD Single Parts catalogue.	1
A5 Sportback (8TA)	3.0 TFSI quattro	200/272	2011/12-2017/01	7AT	RD00008-RI	0BF500043Q	No complete unit, only single parts available! For details please see 4WD Single Parts catalogue.	1
A5 Sportback (8TA)	S5 quattro	245/333	2010/01-2017/01	7AT	RD00008-RI	0BF500043Q	No complete unit, only single parts available! For details please see 4WD Single Parts catalogue.	1

All rights reserved.

This publication may not be reproduced in any form, in whole or in part, without a written approval from S-TEC Service Technologies GmbH & Co OG.  
Subject to change without notice!



### Brand - Series - Sales Name

### Maingroup - Subgroup

Salesname	Model	kW/HP	Model Year	Gearbox	Part Number	OEM Number	Info	Image
-----------	-------	-------	------------	---------	-------------	------------	------	-------

### Audi - A6 - A6 (4G2, 4GC, C7)



Img.1

### Rear Axle - Rear Differential

A6 (4G2, 4GC, C7)	3.0 TDI quattro	160/218	2014/09-	7AT	RD00008-RI	0BF500043Q	No complete unit, only single parts available! For details please see 4WD Single Parts catalogue.	1
A6 (4G2, 4GC, C7)	3.0 TDI quattro	176/239	2014/09-	7AT	RD00008-RI	0BF500043Q	No complete unit, only single parts available! For details please see 4WD Single Parts catalogue.	1
A6 (4G2, 4GC, C7)	3.0 TDI quattro	180/245	2014/09-	7AT	RD00008-RI	0BF500043Q	No complete unit, only single parts available! For details please see 4WD Single Parts catalogue.	1
A6 (4G2, 4GC, C7)	3.0 TDI quattro	200/272	2014/09-	7AT	RD00008-RI	0BF500043Q	No complete unit, only single parts available! For details please see 4WD Single Parts catalogue.	1

All rights reserved.

This publication may not be reproduced in any form, in whole or in part, without a written approval from S-TEC Service Technologies GmbH & Co OG.  
Subject to change without notice!

## Brand - Series - Sales Name

### Maingroup - Subgroup

Salesname	Model	kW/HP	Model Year	Gearbox	Part Number	OEM Number	Info	Image
-----------	-------	-------	------------	---------	-------------	------------	------	-------

## Audi - A6 - A6 Avant (4G5, 4GD, C7)



Img.1

### Rear Axle - Rear Differential

A6 Avant (4G5, 4GD, C7)	3.0 TDI quattro	160/218	2014/09-	7AT	RD00008-RI	0BF500043Q	No complete unit, only single parts available! For details please see 4WD Single Parts catalogue.	1
A6 Avant (4G5, 4GD, C7)	3.0 TDI quattro	180/245	2014/09-	7AT	RD00008-RI	0BF500043Q	No complete unit, only single parts available! For details please see 4WD Single Parts catalogue.	1
A6 Avant (4G5, 4GD, C7)	3.0 TDI quattro	200/272	2014/09-	7AT	RD00008-RI	0BF500043Q	No complete unit, only single parts available! For details please see 4WD Single Parts catalogue.	1
A6 Avant (4G5, 4GD, C7)	3.0 TDI quattro	235/320	2014/09-	7AT	RD00008-RI	0BF500043Q	No complete unit, only single parts available! For details please see 4WD Single Parts catalogue.	1
A6 Avant (4G5, 4GD, C7)	3.0 TDI quattro	240/326	2014/09-	7AT	RD00008-RI	0BF500043Q	No complete unit, only single parts available! For details please see 4WD Single Parts catalogue.	1
A6 Avant (4G5, 4GD, C7)	3.0 TFSI quattro	228/310	2014/09-	7AT	RD00008-RI	0BF500043Q	No complete unit, only single parts available! For details please see 4WD Single Parts catalogue.	1
A6 Avant (4G5, 4GD, C7)	3.0 TFSI quattro	245/333	2014/09-	7AT	RD00008-RI	0BF500043Q	No complete unit, only single parts available! For details please see 4WD Single Parts catalogue.	1

## Audi - A6 allroad - ALLROAD (4BH, C5)



Img.1

### Gearbox, Powertrain - Gearbox

ALLROAD (4BH, C5)	2.5 TDI quattro	120/163	2003/05-2005/08	6MT	SP00442	01E300009A	Diesel	1
ALLROAD (4BH, C5)	2.5 TDI quattro	132/180	2000/05-2005/08	6MT	SP00442	01E300009A	Diesel	1
ALLROAD (4BH, C5)	2.7 T quattro	184/250	2000/05-2005/08	6MT	SP00441	01E300009	Biturbo	1

All rights reserved.

This publication may not be reproduced in any form, in whole or in part, without a written approval from S-TEC Service Technologies GmbH & Co OG.  
Subject to change without notice!

### Brand - Series - Sales Name

### Maingroup - Subgroup

Salesname	Model	kW/HP	Model Year	Gearbox	Part Number	OEM Number	Info	Image
-----------	-------	-------	------------	---------	-------------	------------	------	-------

### Audi - A7 - A7 Sportback (4GA, 4GF)



Img.1

### Rear Axle - Rear Differential

A7 Sportback (4GA, 4GF)	3.0 TFSI quattro	220/300	2014/05-	7AT	RD00008-RI	0BF500043Q	No complete unit, only single parts available! For details please see 4WD Single Parts catalogue.	1
A7 Sportback (4GA, 4GF)	3.0 TFSI quattro	228/310	2014/05-	7AT	RD00008-RI	0BF500043Q	No complete unit, only single parts available! For details please see 4WD Single Parts catalogue.	1
A7 Sportback (4GA, 4GF)	3.0 TFSI quattro	245/333	2014/05-	7AT	RD00008-RI	0BF500043Q	No complete unit, only single parts available! For details please see 4WD Single Parts catalogue.	1

### Audi - A8 - A8 (4H2, 4H8, 4HC, 4HL)



Img.1

### Rear Axle - Rear Differential

A8 (4H2, 4H8, 4HC, 4HL)	4.0 TFSI quattro	309/420	2012/03-	8AT	RD00009-RI	0BE500043C	No complete unit, only single parts available! For details please see 4WD Single Parts catalogue.	1
A8 (4H2, 4H8, 4HC, 4HL)	4.0 TFSI quattro	320/435	2013/10-	8AT	RD00009-RI	0BE500043C	No complete unit, only single parts available! For details please see 4WD Single Parts catalogue.	1
A8 (4H2, 4H8, 4HC, 4HL)	4.2 TDI quattro	258/351	2009/11-	8AT	RD00009-RI	0BE500043C	No complete unit, only single parts available! For details please see 4WD Single Parts catalogue.	1
A8 (4H2, 4H8, 4HC, 4HL)	4.2 TDI quattro	283/385	2013/10-	8AT	RD00009-RI	0BE500043C	No complete unit, only single parts available! For details please see 4WD Single Parts catalogue.	1

All rights reserved.

This publication may not be reproduced in any form, in whole or in part, without a written approval from S-TEC Service Technologies GmbH & Co OG.  
Subject to change without notice!

### Brand - Series - Sales Name

### Maingroup - Subgroup

Salesname	Model	kW/HP	Model Year	Gearbox	Part Number	OEM Number	Info	Image
-----------	-------	-------	------------	---------	-------------	------------	------	-------

### Audi - Q3 - Q3 (8UB, 8UG)



Img.1



Img.2

### Front Axle, Steering Unit - Power take off (PTO)

Q3 (8UB, 8UG)	2.0 TDI quattro	103/140	2012/01-2015/04	6MT	FD00049-RI	0A6409053AG		1
Q3 (8UB, 8UG)	2.0 TDI quattro	103/140	2012/01-2015/04	7AT	FD00060-RI	0A6409053AH		1
Q3 (8UB, 8UG)	2.0 TDI quattro	103/140	2012/01-2015/04	6MT	FD00052-RI	0AV409053AE		2
Q3 (8UB, 8UG)	2.0 TDI quattro	103/140	2015/04-	6MT	FD00021-RI	0A6409053AK		
Q3 (8UB, 8UG)	2.0 TDI quattro	110/150	2014/11-2015/04	6MT	FD00052-RI	0AV409053AE		2
Q3 (8UB, 8UG)	2.0 TDI quattro	110/150	2014/11-	7AT	FD00060-RI	0A6409053AH		1
Q3 (8UB, 8UG)	2.0 TDI quattro	120/163	2011/06-2015/04	6MT	FD00049-RI	0A6409053AG		1
Q3 (8UB, 8UG)	2.0 TDI quattro	120/163	2011/06-2015/04	6MT	FD00052-RI	0AV409053AE		2
Q3 (8UB, 8UG)	2.0 TDI quattro	120/163	2011/06-	7AT	FD00060-RI	0A6409053AH		1
Q3 (8UB, 8UG)	2.0 TDI quattro	120/163	2015/04-	6MT	FD00021-RI	0A6409053AK		
Q3 (8UB, 8UG)	2.0 TDI quattro	130/177	2011/06-2015/04	6MT	FD00052-RI	0AV409053AE		2
Q3 (8UB, 8UG)	2.0 TDI quattro	130/177	2011/06-	7AT	FD00060-RI	0A6409053AH		1
Q3 (8UB, 8UG)	2.0 TDI quattro	130/177	2013/05-2015/04	6MT	FD00049-RI	0A6409053AG		1
Q3 (8UB, 8UG)	2.0 TDI quattro	130/177	2015/04-	6MT	FD00021-RI	0A6409053AK		
Q3 (8UB, 8UG)	2.0 TDI quattro	135/184	2013/05-2015/04	6MT	FD00049-RI	0A6409053AG		1
Q3 (8UB, 8UG)	2.0 TDI quattro	135/184	2014/11-2015/04	6MT	FD00052-RI	0AV409053AE		2
Q3 (8UB, 8UG)	2.0 TDI quattro	135/184	2014/11-	7AT	FD00060-RI	0A6409053AH		1
Q3 (8UB, 8UG)	2.0 TFSI quattro	125/170	2011/06-2015/04	6MT	FD00052-RI	0AV409053AE		2
Q3 (8UB, 8UG)	2.0 TFSI quattro	125/170	2011/06-2015/04	7AT	FD00060-RI	0A6409053AH		1
Q3 (8UB, 8UG)	2.0 TFSI quattro	125/170	2013/05-2015/04	6MT	FD00049-RI	0A6409053AG		1
Q3 (8UB, 8UG)	2.0 TFSI quattro	125/170	2015/04-	6MT	FD00021-RI	0A6409053AK		
Q3 (8UB, 8UG)	2.0 TFSI quattro	132/180	2014/11-2015/04	6MT	FD00052-RI	0AV409053AE		2
Q3 (8UB, 8UG)	2.0 TFSI quattro	132/180	2014/11-2015/04	7AT	FD00060-RI	0A6409053AH		1
Q3 (8UB, 8UG)	2.0 TFSI quattro	147/200	2014/09-2015/04	7AT	FD00060-RI	0A6409053AH		1
Q3 (8UB, 8UG)	2.0 TFSI quattro	147/200	2014/09-2015/04	6MT	FD00049-RI	0A6409053AG		1
Q3 (8UB, 8UG)	2.0 TFSI quattro	147/200	2014/09-2015/04	6MT	FD00052-RI	0AV409053AE		2
Q3 (8UB, 8UG)	2.0 TFSI quattro	147/200	2015/04-	6MT	FD00021-RI	0A6409053AK		
Q3 (8UB, 8UG)	2.0 TFSI quattro	155/211	2011/06-2015/04	6MT	FD00052-RI	0AV409053AE		2
Q3 (8UB, 8UG)	2.0 TFSI quattro	155/211	2011/06-2015/04	7AT	FD00060-RI	0A6409053AH		1
Q3 (8UB, 8UG)	2.0 TFSI quattro	162/220	2013/05-	7AT	FD00060-RI	0A6409053AH		1
Q3 (8UB, 8UG)	2.0 TFSI quattro	162/220	2014/11-2015/04	6MT	FD00052-RI	0AV409053AE		2
Q3 (8UB, 8UG)	RS 2.5 quattro	228/310	2013/10-	7AT	FD00060-RI	0A6409053AH		1
Q3 (8UB, 8UG)	RS 2.5 quattro	250/340	2013/05-	7AT	FD00060-RI	0A6409053AH		1
Q3 (8UB, 8UG)	RS 2.5 quattro	270/367	2015/01-	7AT	FD00060-RI	0A6409053AH		1

All rights reserved.

This publication may not be reproduced in any form, in whole or in part, without a written approval from S-TEC Service Technologies GmbH & Co OG.  
Subject to change without notice!

### Brand - Series - Sales Name

### Maingroup - Subgroup

Salesname	Model	kW/HP	Model Year	Gearbox	Part Number	OEM Number	Info	Image
-----------	-------	-------	------------	---------	-------------	------------	------	-------

### Audi - Q3 - Q3 (8UB, 8UG)



Img.1

### Rear Axle - Rear Differential

Q3 (8UB, 8UG)	2.0 TDI quattro	103/140	2012/01-2013/11	7AT	RD00074-RI	OBS525010H		1
Q3 (8UB, 8UG)	2.0 TDI quattro	103/140	2012/01-2013/11	6MT	RD00074-RI	OBS525010H		1
Q3 (8UB, 8UG)	2.0 TDI quattro	103/140	2013/11-	6MT	RD00100-RI	0AY525010N		1
Q3 (8UB, 8UG)	2.0 TDI quattro	103/140	2013/11-	7AT	RD00100-RI	0AY525010N		1
Q3 (8UB, 8UG)	2.0 TDI quattro	110/150	2014/11-	6MT	RD00100-RI	0AY525010N		1
Q3 (8UB, 8UG)	2.0 TDI quattro	110/150	2014/11-	7AT	RD00100-RI	0AY525010N		1
Q3 (8UB, 8UG)	2.0 TDI quattro	120/163	2011/06-2011/09	7AT	RD00061-RI	OBS525010G		1
Q3 (8UB, 8UG)	2.0 TDI quattro	120/163	2011/06-2011/09	6MT	RD00061-RI	OBS525010G		1
Q3 (8UB, 8UG)	2.0 TDI quattro	120/163	2011/09-2013/11	6MT	RD00074-RI	OBS525010H		1
Q3 (8UB, 8UG)	2.0 TDI quattro	120/163	2011/09-2013/11	7AT	RD00074-RI	OBS525010H		1
Q3 (8UB, 8UG)	2.0 TDI quattro	120/163	2013/11-	7AT	RD00100-RI	0AY525010N		1
Q3 (8UB, 8UG)	2.0 TDI quattro	120/163	2013/11-	6MT	RD00100-RI	0AY525010N		1
Q3 (8UB, 8UG)	2.0 TDI quattro	130/177	2011/06-2011/09	7AT	RD00061-RI	OBS525010G		1
Q3 (8UB, 8UG)	2.0 TDI quattro	130/177	2011/06-2011/09	6MT	RD00061-RI	OBS525010G		1
Q3 (8UB, 8UG)	2.0 TDI quattro	130/177	2011/09-2013/11	6MT	RD00074-RI	OBS525010H		1
Q3 (8UB, 8UG)	2.0 TDI quattro	130/177	2011/09-2013/11	7AT	RD00074-RI	OBS525010H		1
Q3 (8UB, 8UG)	2.0 TDI quattro	130/177	2013/11-	7AT	RD00100-RI	0AY525010N		1
Q3 (8UB, 8UG)	2.0 TDI quattro	130/177	2013/11-	6MT	RD00100-RI	0AY525010N		1
Q3 (8UB, 8UG)	2.0 TDI quattro	135/184	2014/11-	6MT	RD00100-RI	0AY525010N		1
Q3 (8UB, 8UG)	2.0 TDI quattro	135/184	2014/11-	7AT	RD00100-RI	0AY525010N		1
Q3 (8UB, 8UG)	2.0 TFSI quattro	125/170	2011/06-2011/09	6MT	RD00061-RI	OBS525010G		1
Q3 (8UB, 8UG)	2.0 TFSI quattro	125/170	2011/06-2011/09	7AT	RD00061-RI	OBS525010G		1
Q3 (8UB, 8UG)	2.0 TFSI quattro	125/170	2011/09-2013/11	7AT	RD00074-RI	OBS525010H		1
Q3 (8UB, 8UG)	2.0 TFSI quattro	125/170	2011/09-2013/11	6MT	RD00074-RI	OBS525010H		1
Q3 (8UB, 8UG)	2.0 TFSI quattro	125/170	2013/11-	7AT	RD00100-RI	0AY525010N		1
Q3 (8UB, 8UG)	2.0 TFSI quattro	125/170	2013/11-	6MT	RD00100-RI	0AY525010N		1
Q3 (8UB, 8UG)	2.0 TFSI quattro	132/180	2014/11-	6MT	RD00100-RI	0AY525010N		1
Q3 (8UB, 8UG)	2.0 TFSI quattro	132/180	2014/11-	7AT	RD00100-RI	0AY525010N		1
Q3 (8UB, 8UG)	2.0 TFSI quattro	147/200	2014/09-	7AT	RD00100-RI	0AY525010N		1
Q3 (8UB, 8UG)	2.0 TFSI quattro	147/200	2014/09-	6MT	RD00100-RI	0AY525010N		1
Q3 (8UB, 8UG)	2.0 TFSI quattro	155/211	2011/06-2011/09	6MT	RD00061-RI	OBS525010G		1
Q3 (8UB, 8UG)	2.0 TFSI quattro	155/211	2011/06-2011/09	7AT	RD00061-RI	OBS525010G		1
Q3 (8UB, 8UG)	2.0 TFSI quattro	155/211	2011/09-2013/11	7AT	RD00074-RI	OBS525010H		1
Q3 (8UB, 8UG)	2.0 TFSI quattro	155/211	2011/09-2013/11	6MT	RD00074-RI	OBS525010H		1
Q3 (8UB, 8UG)	2.0 TFSI quattro	155/211	2013/11-	6MT	RD00100-RI	0AY525010N		1
Q3 (8UB, 8UG)	2.0 TFSI quattro	155/211	2013/11-	7AT	RD00100-RI	0AY525010N		1
Q3 (8UB, 8UG)	2.0 TFSI quattro	162/220	2014/11-	7AT	RD00100-RI	0AY525010N		1

All rights reserved.

This publication may not be reproduced in any form, in whole or in part, without a written approval from S-TEC Service Technologies GmbH & Co OG.  
Subject to change without notice!

## Brand - Series - Sales Name

### Maingroup - Subgroup

Salesname	Model	kW/HP	Model Year	Gearbox	Part Number	OEM Number	Info	Image
-----------	-------	-------	------------	---------	-------------	------------	------	-------

## Audi - Q3 - Q3 (8UB, 8UG)

### Rear Axle - Rear Differential

Q3 (8UB, 8UG)	2.0 TFSI quattro	162/220	2014/11-	6MT	RD00100-RI	0AY525010N		1
Q3 (8UB, 8UG)	RS 2.5 quattro	228/310	2013/10-	7AT	RD00099-RI	0BS525010K		1
Q3 (8UB, 8UG)	RS 2.5 quattro	250/340	2013/05-	7AT	RD00099-RI	0BS525010K		1
Q3 (8UB, 8UG)	RS 2.5 quattro	270/367	2015/01-	7AT	RD00099-RI	0BS525010K		1

## Audi - Q7 - Q7 (4LB)



Img.1



Img.2



Img.3

### Gearbox, Powertrain - Transfer Case

Q7 (4LB)	3.0 TDI quattro	150/204	2010/05-2015/08	8DCT	TC00302-RI	0BU341010N	Neck length: 155,7 ; with differential lock	1
Q7 (4LB)	3.0 TDI quattro	165/224	2009/06-2012/05	8DCT	TC00302-RI	0BU341010N	Neck length 127,4	1
Q7 (4LB)	3.0 TDI quattro	176/240	2007/11-2010/04	8DCT	TC00302-RI	0BU341010N	Neck length 127,4	1
Q7 (4LB)	3.0 TDI quattro	180/245	2011/05-2015/08	8DCT	TC00302-RI	0BU341010N	Neck length 127,4	1
Q7 (4LB)	3.0 TDI quattro	209/284	2008/09-2010/12	8DCT	TC00306-RI	0BU341010Q	Neck length 191,2	2
Q7 (4LB)	3.0 TFSI quattro	200/272	2010/05-2015/08	8DCT	TC00306-RI	0BU341010Q	Neck length 191,2	2
Q7 (4LB)	3.0 TFSI quattro	206/280	2011/05-2015/08	8DCT	TC00306-RI	0BU341010Q	Neck length 191,2	2
Q7 (4LB)	3.0 TFSI quattro	245/333	2010/05-2015/08	8DCT	TC00306-RI	0BU341010Q	Neck length 191,2	2
Q7 (4LB)	3.6 FSI quattro	206/280	2006/08-2010/05	6AT	TC00302-RI	0BU341010N	Neck length 127,4	1
Q7 (4LB)	3.6 FSI quattro	206/280	2006/08-2010/05	6MT	TC00302-RI	0BU341010N	Neck length 127,4	1
Q7 (4LB)	4.2 TDI quattro	250/340	2009/05-2015/08	8DCT	TC00304-RI	0BU341010P	Neck length: 155,7 ; with differential lock	3

All rights reserved.

This publication may not be reproduced in any form, in whole or in part, without a written approval from S-TEC Service Technologies GmbH & Co OG.  
Subject to change without notice!

### Brand - Series - Sales Name

### Maingroup - Subgroup

Salesname	Model	kW/HP	Model Year	Gearbox	Part Number	OEM Number	Info	Image
-----------	-------	-------	------------	---------	-------------	------------	------	-------

### Audi - TT - TT (8J3)



Img.1



Img.2

### Front Axle, Steering Unit - Power take off (PTO)

TT (8J3)	2.0 TDI quattro	125/170	2008/06-2014/06	6MT	FD00052-RI	0AV409053AE		1
TT (8J3)	2.0 TDI quattro	125/170	2008/06-2014/06	6AT	FD00053-RI	0AV409053AF		1
TT (8J3)	2.0 TFSI quattro	147/200	2008/06-2010/06	6MT	FD00052-RI	0AV409053AE		1
TT (8J3)	2.0 TFSI quattro	147/200	2008/06-2010/06	6AT	FD00053-RI	0AV409053AF		1
TT (8J3)	2.0 TFSI quattro	155/211	2010/05-2014/06	6AT	FD00053-RI	0AV409053AF		1
TT (8J3)	2.0 TFSI quattro	155/211	2010/05-2014/06	6MT	FD00052-RI	0AV409053AE		1
TT (8J3)	2.0 TTS quattro	195/265	2008/05-2014/06	6MT	FD00052-RI	0AV409053AE		1
TT (8J3)	2.0 TTS quattro	195/265	2008/05-2014/06	6AT	FD00053-RI	0AV409053AF		1
TT (8J3)	2.0 TTS quattro	200/272	2008/05-2014/06	6MT	FD00052-RI	0AV409053AE		1
TT (8J3)	2.0 TTS quattro	200/272	2008/05-2014/06	6AT	FD00053-RI	0AV409053AF		1
TT (8J3)	2.5 RS quattro	250/340	2009/07-2014/06	6MT	FD00049-RI	0A6409053AG		2
TT (8J3)	2.5 RS quattro	250/340	2009/07-2014/06	7AT	FD00060-RI	0A6409053AH		2
TT (8J3)	2.5 RS quattro	265/360	2011/05-2014/06	6MT	FD00049-RI	0A6409053AG		2
TT (8J3)	2.5 RS quattro	265/360	2011/05-2014/06	7AT	FD00060-RI	0A6409053AH		2
TT (8J3)	3.2 V6 quattro	184/250	2006/08-2006/10	6AT	FD00042-RI	02M409050AX; 02M409053AT		1
TT (8J3)	3.2 V6 quattro	184/250	2006/08-2010/06	6MT	FD00052-RI	0AV409053AE		1
TT (8J3)	3.2 V6 quattro	184/250	2006/11-2010/06	6AT	FD00053-RI	0AV409053AF		1



Img.1



Img.2



Img.3

### Rear Axle - Rear Differential

TT (8J3)	2.0 TDI quattro	125/170	2008/06-2014/06	6MT	RD00059-RI	0BR525010G		1
TT (8J3)	2.0 TDI quattro	125/170	2008/06-2014/06	6AT	RD00059-RI	0BR525010G		1
TT (8J3)	2.0 TFSI quattro	147/200	2008/06-2010/06	6MT	RD00059-RI	0BR525010G		1
TT (8J3)	2.0 TFSI quattro	147/200	2008/06-2010/06	6AT	RD00059-RI	0BR525010G		1
TT (8J3)	2.0 TFSI quattro	155/211	2010/05-2014/06	6MT	RD00059-RI	0BR525010G		1
TT (8J3)	2.0 TFSI quattro	155/211	2010/05-2014/06	6AT	RD00059-RI	0BR525010G		1
TT (8J3)	2.0 TTS quattro	195/265	2008/05-2014/06	6AT	RD00059-RI	0BR525010G		1
TT (8J3)	2.0 TTS quattro	195/265	2008/05-2014/06	6MT	RD00059-RI	0BR525010G		1
TT (8J3)	2.0 TTS quattro	200/272	2008/05-2014/06	6AT	RD00059-RI	0BR525010G		1
TT (8J3)	2.0 TTS quattro	200/272	2008/05-2014/06	6MT	RD00059-RI	0BR525010G		1
TT (8J3)	2.5 RS quattro	250/340	2009/07-2014/06	7AT	RD00007-RI	0BY525010B		2
TT (8J3)	2.5 RS quattro	250/340	2009/07-2014/06	6MT	RD00007-RI	0BY525010B		2
TT (8J3)	2.5 RS quattro	265/360	2011/05-2014/06	6MT	RD00007-RI	0BY525010B		2
TT (8J3)	2.5 RS quattro	265/360	2011/05-2014/06	7AT	RD00007-RI	0BY525010B		2
TT (8J3)	3.2 V6 quattro	184/250	2006/08-2009/10	6MT	RD00022-RI	0AV525010K		3
TT (8J3)	3.2 V6 quattro	184/250	2006/08-2010/06	6AT	RD00022-RI	0AV525010K		3

All rights reserved.

This publication may not be reproduced in any form, in whole or in part, without a written approval from S-TEC Service Technologies GmbH & Co OG.  
Subject to change without notice!

### Brand - Series - Sales Name

### Maingroup - Subgroup

Salesname	Model	kW/HP	Model Year	Gearbox	Part Number	OEM Number	Info	Image
-----------	-------	-------	------------	---------	-------------	------------	------	-------

### Audi - TT - TT (8J3)

#### Rear Axle - Rear Differential

TT (8J3)	3.2 V6 quattro	184/250	2009/11-2010/06	6AT	RD00059-RI	0BR525010G		1
TT (8J3)	3.2 V6 quattro	184/250	2009/11-2010/06	6MT	RD00059-RI	0BR525010G		1

### Audi - TT - TT (8N3)



Img.1

#### Front Axle, Steering Unit - Power take off (PTO)

TT (8N3)	1.8 T quattro	132/180	1998/10-2006/06	6AT	FD00041-RI	02M409050X; 02M409053AP		1
TT (8N3)	1.8 T quattro	140/190	2005/09-2006/06	6AT	FD00041-RI	02M409050X; 02M409053AP		1
TT (8N3)	1.8 T quattro	176/240	2005/03-2006/06	6AT	FD00041-RI	02M409050X; 02M409053AP		1
TT (8N3)	3.2 VR6 quattro	184/250	2003/07-2006/06	6AT	FD00041-RI	02M409050X; 02M409053AP		1

All rights reserved.

This publication may not be reproduced in any form, in whole or in part, without a written approval from S-TEC Service Technologies GmbH & Co OG.  
Subject to change without notice!



### Brand - Series - Sales Name

### Maingroup - Subgroup

Salesname	Model	kW/HP	Model Year	Gearbox	Part Number	OEM Number	Info	Image
-----------	-------	-------	------------	---------	-------------	------------	------	-------

### Audi - TT - TT Roadster (8J9)



Img.1



Img.2

### Front Axle, Steering Unit - Power take off (PTO)

TT Roadster (8J9)	2.0 TDI quattro	125/170	2008/06-2014/06	6MT	FD00052-RI	0AV409053AE		1
TT Roadster (8J9)	2.0 TDI quattro	125/170	2008/06-2014/06	6AT	FD00053-RI	0AV409053AF		1
TT Roadster (8J9)	2.0 TFSI quattro	147/200	2008/06-2010/06	6AT	FD00053-RI	0AV409053AF		1
TT Roadster (8J9)	2.0 TFSI quattro	155/211	2010/05-2014/06	6MT	FD00052-RI	0AV409053AE		1
TT Roadster (8J9)	2.0 TFSI quattro	155/211	2010/05-2014/06	6AT	FD00053-RI	0AV409053AF		1
TT Roadster (8J9)	2.0 TTS quattro	195/265	2008/05-2014/06	6MT	FD00052-RI	0AV409053AE		1
TT Roadster (8J9)	2.0 TTS quattro	195/265	2008/05-2014/06	6AT	FD00053-RI	0AV409053AF		1
TT Roadster (8J9)	2.0 TTS quattro	200/272	2008/05-2014/06	6AT	FD00053-RI	0AV409053AF		1
TT Roadster (8J9)	2.0 TTS quattro	200/272	2008/05-2014/06	6MT	FD00052-RI	0AV409053AE		1
TT Roadster (8J9)	2.5 RS quattro	250/340	2009/07-2014/06	7MT	FD00060-RI	0A6409053AH		2
TT Roadster (8J9)	2.5 RS quattro	250/340	2009/07-2014/06	6MT	FD00049-RI	0A6409053AG		2
TT Roadster (8J9)	2.5 RS quattro	250/340	2009/07-2014/06	7AT	FD00060-RI	0A6409053AH		2
TT Roadster (8J9)	2.5 RS quattro	265/360	2012/03-2014/06	7AT	FD00060-RI	0A6409053AH		2
TT Roadster (8J9)	2.5 RS quattro	265/360	2012/03-2014/06	7MT	FD00060-RI	0A6409053AH		2
TT Roadster (8J9)	2.5 RS quattro	265/360	2012/03-2014/06	6MT	FD00049-RI	0A6409053AG		2
TT Roadster (8J9)	3.2 V6 quattro	184/250	2007/03-2010/06	6MT	FD00052-RI	0AV409053AE		1
TT Roadster (8J9)	3.2 V6 quattro	184/250	2007/03-2010/06	6AT	FD00053-RI	0AV409053AF		1



Img.1



Img.2

### Rear Axle - Rear Differential

TT Roadster (8J9)	2.0 TDI quattro	125/170	2008/06-2014/06	6AT	RD00060-RI	0BR525010H		1
TT Roadster (8J9)	2.0 TDI quattro	125/170	2008/06-2014/06	6MT	RD00060-RI	0BR525010H		1
TT Roadster (8J9)	2.0 TFSI quattro	147/200	2008/06-2010/06	6AT	RD00060-RI	0BR525010H		1
TT Roadster (8J9)	2.0 TFSI quattro	155/211	2010/05-2014/06	6MT	RD00060-RI	0BR525010H		1
TT Roadster (8J9)	2.0 TFSI quattro	155/211	2010/05-2014/06	6AT	RD00060-RI	0BR525010H		1
TT Roadster (8J9)	2.0 TTS quattro	195/265	2008/05-2014/06	6AT	RD00060-RI	0BR525010H		1
TT Roadster (8J9)	2.0 TTS quattro	195/265	2008/05-2014/06	6MT	RD00060-RI	0BR525010H		1
TT Roadster (8J9)	2.0 TTS quattro	200/272	2008/05-2014/06	6AT	RD00060-RI	0BR525010H		1
TT Roadster (8J9)	2.0 TTS quattro	200/272	2008/05-2014/06	6MT	RD00060-RI	0BR525010H	PR-K8J	1
TT Roadster (8J9)	2.5 RS quattro	250/340	2009/07-2014/06	6MT	RD00007-RI	0BY525010B		2
TT Roadster (8J9)	2.5 RS quattro	250/340	2009/07-2014/06	7AT	RD00007-RI	0BY525010B		2
TT Roadster (8J9)	2.5 RS quattro	250/340	2009/07-2014/06	7MT	RD00007-RI	0BY525010B		2
TT Roadster (8J9)	2.5 RS quattro	265/360	2012/03-2014/06	7AT	RD00007-RI	0BY525010B		2
TT Roadster (8J9)	2.5 RS quattro	265/360	2012/03-2014/06	7MT	RD00007-RI	0BY525010B		2
TT Roadster (8J9)	2.5 RS quattro	265/360	2012/03-2014/06	6MT	RD00007-RI	0BY525010B		2
TT Roadster (8J9)	3.2 V6 quattro	184/250	2007/03-2009/11	6AT	RD00056-RI	0AV525010M		1
TT Roadster (8J9)	3.2 V6 quattro	184/250	2007/03-2009/11	6MT	RD00056-RI	0AV525010M		1
TT Roadster (8J9)	3.2 V6 quattro	184/250	2009/11-2010/06	6AT	RD00060-RI	0BR525010H		1
TT Roadster (8J9)	3.2 V6 quattro	184/250	2009/11-2010/06	6MT	RD00060-RI	0BR525010H		1

All rights reserved.

This publication may not be reproduced in any form, in whole or in part, without a written approval from S-TEC Service Technologies GmbH & Co OG. Subject to change without notice!

### Brand - Series - Sales Name

### Maingroup - Subgroup

Salesname	Model	kW/HP	Model Year	Gearbox	Part Number	OEM Number	Info	Image
-----------	-------	-------	------------	---------	-------------	------------	------	-------

### Audi - TT - TT Roadster (8N9)



Img.1

### Front Axle, Steering Unit - Power take off (PTO)

TT Roadster (8N9)	1.8 T quattro	132/180	2000/02-2006/06	6AT	FD00041-RI	02M409050X; 02M409053AP		1
TT Roadster (8N9)	1.8 T quattro	140/190	2005/09-2006/06	6AT	FD00041-RI	02M409050X; 02M409053AP		1
TT Roadster (8N9)	3.2 VR6 quattro	184/250	2003/07-2006/06	6AT	FD00041-RI	02M409050X; 02M409053AP		1

All rights reserved.

This publication may not be reproduced in any form, in whole or in part, without a written approval from S-TEC Service Technologies GmbH & Co OG.  
Subject to change without notice!

## Brand - Series - Sales Name

### Maingroup - Subgroup

Salesname	Model	kW/HP	Model Year	Gearbox	Part Number	OEM Number	Info	Image
-----------	-------	-------	------------	---------	-------------	------------	------	-------

## BMW - 1 - (F20)



Img.1



Img.2

### Gearbox, Powertrain - Transfer Case

(F20)	118 d xDrive	105/143	2013/07-2015/07		TC00414-RI	27105A371F0; 27105A371F2		1
(F20)	118 d xDrive	105/143	2015/07-		TC00408-RI	27105A371F1; 27105A371F3		2
(F20)	118 d xDrive	110/150	2015/03-2015/07		TC00414-RI	27105A371F0; 27105A371F2		1
(F20)	118 d xDrive	110/150	2015/07-		TC00408-RI	27105A371F1; 27105A371F3		2
(F20)	120 d xDrive	135/184	2012/02-2015/07		TC00414-RI	27105A371F0; 27105A371F2		1
(F20)	120 d xDrive	135/184	2015/07-		TC00408-RI	27105A371F1; 27105A371F3		2
(F20)	120 d xDrive	140/190	2015/03-2015/07		TC00414-RI	27105A371F0; 27105A371F2		1
(F20)	120 d xDrive	140/190	2015/07-		TC00408-RI	27105A371F1; 27105A371F3		2
(F20)	120 d xDrive	147/200	2011/01-2015/07		TC00414-RI	27105A371F0; 27105A371F2		1
(F20)	120 d xDrive	147/200	2015/07-		TC00408-RI	27105A371F1; 27105A371F3		2
(F20)	120 d xDrive	151/205	2015/03-2019/06		TC00408-RI	27105A371F1; 27105A371F3		2
(F20)	120 d xDrive	151/205	2015/03-2019/06		TC00414-RI	27105A371F0; 27105A371F2		1
(F20)	M 135 i xDrive	235/320	2012/02-2015/07		TC00414-RI	27105A371F0; 27105A371F2		1
(F20)	M 135 i xDrive	235/320	2015/07-		TC00408-RI	27105A371F1; 27105A371F3		2
(F20)	M 135 i xDrive	240/326	2015/03-2015/07		TC00414-RI	27105A371F0; 27105A371F2		1
(F20)	M 135 i xDrive	240/326	2015/07-		TC00408-RI	27105A371F1; 27105A371F3		2
(F20)	M 140 i xDrive	250/340	2016/07-2019/06		TC00414-RI	27105A371F0; 27105A371F2		1

All rights reserved.

This publication may not be reproduced in any form, in whole or in part, without a written approval from S-TEC Service Technologies GmbH & Co OG.  
Subject to change without notice!

## Brand - Series - Sales Name

### Maingroup - Subgroup

Salesname	Model	kW/HP	Model Year	Gearbox	Part Number	OEM Number	Info	Image
-----------	-------	-------	------------	---------	-------------	------------	------	-------

## BMW - 1 - (F21)



Img.1



Img.2

### Gearbox, Powertrain - Transfer Case

(F21)	118 d xDrive	105/143	2013/05-2015/07		TC00414-RI	27105A371F0; 27105A371F2		1
(F21)	118 d xDrive	105/143	2015/07-		TC00408-RI	27105A371F1; 27105A371F3		2
(F21)	118 d xDrive	110/150	2015/03-2015/07		TC00414-RI	27105A371F0; 27105A371F2		1
(F21)	118 d xDrive	110/150	2015/07-		TC00408-RI	27105A371F1; 27105A371F3		2
(F21)	120 d xDrive	135/184	2012/02-2015/07		TC00414-RI	27105A371F0; 27105A371F2		1
(F21)	120 d xDrive	135/184	2015/07-		TC00408-RI	27105A371F1; 27105A371F3		2
(F21)	120 d xDrive	140/190	2015/03-2015/07		TC00414-RI	27105A371F0; 27105A371F2		1
(F21)	120 d xDrive	140/190	2015/07-		TC00408-RI	27105A371F1; 27105A371F3		2
(F21)	120 d xDrive	147/200	2012/01-2015/07		TC00414-RI	27105A371F0; 27105A371F2		1
(F21)	120 d xDrive	147/200	2015/07-		TC00408-RI	27105A371F1; 27105A371F3		2
(F21)	M 135 i xDrive	235/320	2012/02-2015/07		TC00414-RI	27105A371F0; 27105A371F2		1
(F21)	M 135 i xDrive	235/320	2015/07-		TC00408-RI	27105A371F1; 27105A371F3		2
(F21)	M 135 i xDrive	240/326	2015/03-2015/07		TC00414-RI	27105A371F0; 27105A371F2		1
(F21)	M 135 i xDrive	240/326	2015/07-		TC00408-RI	27105A371F1; 27105A371F3		2
(F21)	M 140 i xDrive	250/340	2015/09-2019/06		TC00414-RI	27105A371F0; 27105A371F2		1

All rights reserved.

This publication may not be reproduced in any form, in whole or in part, without a written approval from S-TEC Service Technologies GmbH & Co OG.  
Subject to change without notice!

## Brand - Series - Sales Name

### Maingroup - Subgroup

Salesname	Model	kW/HP	Model Year	Gearbox	Part Number	OEM Number	Info	Image
-----------	-------	-------	------------	---------	-------------	------------	------	-------

## BMW - 2 - (F22, F87)



Img.1



Img.2

### Gearbox, Powertrain - Transfer Case

(F22, F87)	220 d xDrive	120/163	2015/03-2015/07		TC00414-RI	27105A371F0; 27105A371F2		1
(F22, F87)	220 d xDrive	120/163	2015/07-		TC00408-RI	27105A371F1; 27105A371F3		2
(F22, F87)	220 d xDrive	140/190	2015/03-2015/07		TC00414-RI	27105A371F0; 27105A371F2		1
(F22, F87)	220 d xDrive	140/190	2015/07-		TC00408-RI	27105A371F1; 27105A371F3		2
(F22, F87)	220 d xDrive	151/205	2014/06-2020/09		TC00414-RI	27105A371F0; 27105A371F2		1
(F22, F87)	220 d xDrive	151/205	2014/06-2020/09		TC00408-RI	27105A371F1; 27105A371F3		2
(F22, F87)	228 i xDrive	180/245	2014/07-2015/07		TC00414-RI	27105A371F0; 27105A371F2		1
(F22, F87)	228 i xDrive	180/245	2015/07-		TC00408-RI	27105A371F1; 27105A371F3		2
(F22, F87)	230 i xDrive	185/252	2016/09-		TC00414-RI	27105A371F0; 27105A371F2		1
(F22, F87)	M 235 i xDrive	240/326	2014/07-2015/07		TC00414-RI	27105A371F0; 27105A371F2		1
(F22, F87)	M 235 i xDrive	240/326	2015/07-		TC00408-RI	27105A371F1; 27105A371F3		2
(F22, F87)	M 240 i xDrive	250/340	2015/09-		TC00414-RI	27105A371F0; 27105A371F2		1

## BMW - 2 - (F23)



Img.1



Img.2

### Gearbox, Powertrain - Transfer Case

(F23)	228 i xDrive	180/245	2015/09-		TC00408-RI	27105A371F1; 27105A371F3		1
(F23)	230 i xDrive	185/252	2016/09-		TC00414-RI	27105A371F0; 27105A371F2		2
(F23)	M 235 i xDrive	240/326	2015/07-		TC00408-RI	27105A371F1; 27105A371F3		1
(F23)	M 240 i xDrive	250/340	2015/09-		TC00414-RI	27105A371F0; 27105A371F2		2

## BMW - 2 - (G42, G87) Coupe

### Gearbox, Powertrain - Transfer Case

(G42, G87) Coupe	230 i xDrive	190/258	2021/08-		TC00569-RI	27109847753		
(G42, G87) Coupe	M240 i xDrive	275/374	2021/08-		TC00569-RI	27109847753		

All rights reserved.

This publication may not be reproduced in any form, in whole or in part, without a written approval from S-TEC Service Technologies GmbH & Co OG.  
Subject to change without notice!

## Brand - Series - Sales Name

### Maingroup - Subgroup

Salesname	Model	kW/HP	Model Year	Gearbox	Part Number	OEM Number	Info	Image
-----------	-------	-------	------------	---------	-------------	------------	------	-------

## BMW - 3 - (E90)



Img.1



Img.2

### Gearbox, Powertrain - Transfer Case

(E90)	320 d xDrive	120/163	2008/07-2011/12		TC00035-RI	27107599690; 27107599693		1
(E90)	320 d xDrive	130/177	2008/09-2011/12		TC00035-RI	27107599690; 27107599693		1
(E90)	320 d xDrive	135/184	2010/01-2011/12		TC00285-RI	27107613152; 27107613153		2
(E90)	320 xd	130/177	2007/09-2011/12		TC00035-RI	27107599690; 27107599693		1
(E90)	325 i xDrive	160/218	2008/06-2011/10		TC00035-RI	27107599690; 27107599693		1
(E90)	325 xi	160/218	2005/01-2011/12		TC00035-RI	27107599690; 27107599693		1
(E90)	328 i xDrive	171/234	2008/09-2010/12		TC00035-RI	27107599690; 27107599693		1
(E90)	328 xi	171/234	2006/09-2008/12		TC00035-RI	27107599690; 27107599693		1
(E90)	330 d xDrive	180/245	2009/01-2011/12		TC00035-RI	27107599690; 27107599693		1
(E90)	330 i xDrive	200/272	2008/09-2011/12		TC00035-RI	27107599690; 27107599693		1
(E90)	330 xd	170/231	2005/09-2011/12		TC00035-RI	27107599690; 27107599693		1
(E90)	330 xi	190/258	2005/01-2007/08		TC00035-RI	27107599690; 27107599693		1
(E90)	330 xi	200/272	2007/09-2011/12		TC00035-RI	27107599690; 27107599693		1
(E90)	335 i xDrive	224/305	2008/09-2011/12		TC00035-RI	27107599690; 27107599693		1
(E90)	335 i xDrive	225/306	2008/09-2011/12		TC00035-RI	27107599690; 27107599693		1
(E90)	335 i xDrive	240/326	2008/05-2011/10		TC00035-RI	27107599690; 27107599693		1
(E90)	335 xi	224/305	2006/09-2008/12		TC00035-RI	27107599690; 27107599693		1
(E90)	335 xi	225/306	2007/09-2011/12		TC00035-RI	27107599690; 27107599693		1

All rights reserved.

This publication may not be reproduced in any form, in whole or in part, without a written approval from S-TEC Service Technologies GmbH & Co OG.  
Subject to change without notice!

## Brand - Series - Sales Name

### Maingroup - Subgroup

Salesname	Model	kW/HP	Model Year	Gearbox	Part Number	OEM Number	Info	Image
-----------	-------	-------	------------	---------	-------------	------------	------	-------

## BMW - 3 - (E91) Touring



Img.1



Img.2

### Gearbox, Powertrain - Transfer Case

(E91) Touring	320 d xDrive	120/163	2009/07-2012/06		TC00035-RI	27107599690; 27107599693		1
(E91) Touring	320 d xDrive	130/177	2008/09-2012/06		TC00035-RI	27107599690; 27107599693		1
(E91) Touring	320 d xDrive	135/184	2010/01-2012/06		TC00035-RI	27107599690; 27107599693		1
(E91) Touring	320 xd	130/177	2007/09-2012/06		TC00285-RI	27107613152; 27107613153		2
(E91) Touring	325 i xDrive	160/218	2007/09-2012/06		TC00035-RI	27107599690; 27107599693		1
(E91) Touring	325 xi	160/218	2005/09-2012/06		TC00035-RI	27107599690; 27107599693		1
(E91) Touring	328 i xDrive	171/234	2008/09-2010/12		TC00035-RI	27107599690; 27107599693		1
(E91) Touring	328 xi	171/234	2006/09-2008/12		TC00035-RI	27107599690; 27107599693		1
(E91) Touring	330 d xDrive	180/245	2009/01-2012/06		TC00035-RI	27107599690; 27107599693		1
(E91) Touring	330 i xDrive	200/272	2007/09-2012/06		TC00035-RI	27107599690; 27107599693		1
(E91) Touring	330 xd	170/231	2005/09-2012/06		TC00035-RI	27107599690; 27107599693		1
(E91) Touring	330 xi	190/258	2005/09-2007/08		TC00035-RI	27107599690; 27107599693		1
(E91) Touring	330 xi	200/272	2007/09-2012/06		TC00035-RI	27107599690; 27107599693		1
(E91) Touring	335 i xDrive	225/306	2008/09-2012/06		TC00035-RI	27107599690; 27107599693		1
(E91) Touring	335 i xDrive	240/326	2006/09-2012/06		TC00035-RI	27107599690; 27107599693		1
(E91) Touring	335 xi	225/306	2007/03-2012/06		TC00035-RI	27107599690; 27107599693		1

All rights reserved.

This publication may not be reproduced in any form, in whole or in part, without a written approval from S-TEC Service Technologies GmbH & Co OG.  
Subject to change without notice!

## Brand - Series - Sales Name

### Maingroup - Subgroup

Salesname	Model	kW/HP	Model Year	Gearbox	Part Number	OEM Number	Info	Image
-----------	-------	-------	------------	---------	-------------	------------	------	-------

## BMW - 3 - (E92) Coupe



Img.1



Img.2

### Gearbox, Powertrain - Transfer Case

(E92) Coupe	320 d xDrive	130/177	2008/09-2013/12		TC00035-RI	27107599690; 27107599693		1
(E92) Coupe	320 d xDrive	135/184	2010/01-2013/12		TC00285-RI	27107613152; 27107613153		2
(E92) Coupe	320 xd	130/177	2007/03-2013/12		TC00035-RI	27107599690; 27107599693		1
(E92) Coupe	325 i xDrive	150/204	2006/09-2013/12		TC00035-RI	27107599690; 27107599693		1
(E92) Coupe	325 i xDrive	160/218	2008/09-2013/12		TC00035-RI	27107599690; 27107599693		1
(E92) Coupe	325 xi	160/218	2006/09-2013/12		TC00035-RI	27107599690; 27107599693		1
(E92) Coupe	328 i xDrive	171/233	2009/09-2013/12		TC00035-RI	27107599690; 27107599693		1
(E92) Coupe	328 xi	171/233	2006/09-2007/12		TC00035-RI	27107599690; 27107599693		1
(E92) Coupe	330 d xDrive	180/245	2009/01-2013/12		TC00035-RI	27107599690; 27107599693		1
(E92) Coupe	330 i xDrive	200/272	2008/09-2013/12		TC00035-RI	27107599690; 27107599693		1
(E92) Coupe	330 xd	170/231	2006/09-2013/12		TC00035-RI	27107599690; 27107599693		1
(E92) Coupe	330 xd	180/245	2009/01-2013/12		TC00035-RI	27107599690; 27107599693		1
(E92) Coupe	330 xi	190/258	2006/09-2013/12		TC00035-RI	27107599690; 27107599693		1
(E92) Coupe	330 xi	200/272	2006/09-2013/12		TC00035-RI	27107599690; 27107599693		1
(E92) Coupe	335 i xDrive	225/306	2008/09-2013/12		TC00035-RI	27107599690; 27107599693		1
(E92) Coupe	335 xi	225/306	2006/09-2013/12		TC00035-RI	27107599690; 27107599693		1

All rights reserved.

This publication may not be reproduced in any form, in whole or in part, without a written approval from S-TEC Service Technologies GmbH & Co OG.  
Subject to change without notice!



### Brand - Series - Sales Name

### Maingroup - Subgroup

Salesname	Model	kW/HP	Model Year	Gearbox	Part Number	OEM Number	Info	Image
-----------	-------	-------	------------	---------	-------------	------------	------	-------

### BMW - 3 - (F30, F80)



Img.1



Img.2

### Gearbox, Powertrain - Transfer Case

(F30, F80)	318 d xDrive	105/143	2012/11-2015/07		TC00408-RI	27105A371F1; 27105A371F3		1
(F30, F80)	318 d xDrive	105/143	2015/07-		TC00414-RI	27105A371F0; 27105A371F2		2
(F30, F80)	318 d xDrive	110/150	2015/07-		TC00414-RI	27105A371F0; 27105A371F2		2
(F30, F80)	320 d xDrive	120/163	2012/05-2015/07		TC00408-RI	27105A371F1; 27105A371F3		1
(F30, F80)	320 d xDrive	120/163	2015/07-		TC00414-RI	27105A371F0; 27105A371F2		2
(F30, F80)	320 d xDrive	135/184	2011/10-2015/07		TC00408-RI	27105A371F1; 27105A371F3		1
(F30, F80)	320 d xDrive	140/190	2015/07-		TC00414-RI	27105A371F0; 27105A371F2		2
(F30, F80)	320 d xDrive	147/200	2012/05-2015/07		TC00408-RI	27105A371F1; 27105A371F3		1
(F30, F80)	320 d xDrive	147/200	2015/07-		TC00414-RI	27105A371F0; 27105A371F2		2
(F30, F80)	320 i xDrive	134/182	2012/09-2015/07		TC00408-RI	27105A371F1; 27105A371F3		1
(F30, F80)	320 i xDrive	134/182	2015/07-		TC00414-RI	27105A371F0; 27105A371F2		2
(F30, F80)	320 i xDrive	135/184	2011/11-2015/07		TC00408-RI	27105A371F1; 27105A371F3		1
(F30, F80)	320 i xDrive	135/184	2015/07-		TC00414-RI	27105A371F0; 27105A371F2		2
(F30, F80)	328 i xDrive	180/245	2011/10-2015/07		TC00408-RI	27105A371F1; 27105A371F3		1
(F30, F80)	328 i xDrive	180/245	2015/07-		TC00414-RI	27105A371F0; 27105A371F2		2
(F30, F80)	330 d xDrive	190/258	2013/03-2015/07		TC00408-RI	27105A371F1; 27105A371F3		1
(F30, F80)	330 d xDrive	190/258	2015/07-		TC00414-RI	27105A371F0; 27105A371F2		2
(F30, F80)	330 d xDrive	210/286	2015/09-		TC00414-RI	27105A371F0; 27105A371F2		2
(F30, F80)	330 i xDrive	185/252	2015/07-		TC00414-RI	27105A371F0; 27105A371F2		2
(F30, F80)	335 d xDrive	230/313	2013/07-2015/07		TC00408-RI	27105A371F1; 27105A371F3		1
(F30, F80)	335 d xDrive	230/313	2015/07-		TC00414-RI	27105A371F0; 27105A371F2		2
(F30, F80)	335 i xDrive	225/306	2015/07-		TC00414-RI	27105A371F0; 27105A371F2		2
(F30, F80)	335 i xDrive	240/326	2012/07-2013/06		TC00408-RI	27105A371F1; 27105A371F3		1
(F30, F80)	335 i xDrive	250/340	2015/07-		TC00414-RI	27105A371F0; 27105A371F2		2
(F30, F80)	340 i xDrive	240/326	2015/07-		TC00414-RI	27105A371F0; 27105A371F2		2
(F30, F80)	340 i xDrive	265/360	2015/10-		TC00414-RI	27105A371F0; 27105A371F2		2

All rights reserved.

This publication may not be reproduced in any form, in whole or in part, without a written approval from S-TEC Service Technologies GmbH & Co OG.  
Subject to change without notice!

## Brand - Series - Sales Name

### Maingroup - Subgroup

Salesname	Model	kW/HP	Model Year	Gearbox	Part Number	OEM Number	Info	Image
-----------	-------	-------	------------	---------	-------------	------------	------	-------

## BMW - 3 - (F31) Touring



Img.1



Img.2

### Gearbox, Powertrain - Transfer Case

(F31) Touring	318 d xDrive	105/143	2013/01-2015/07		TC00408-RI	27105A371F1; 27105A371F3		1
(F31) Touring	318 d xDrive	105/143	2015/07-		TC00414-RI	27105A371F0; 27105A371F2		2
(F31) Touring	318 d xDrive	110/150	2015/07-		TC00414-RI	27105A371F0; 27105A371F2		2
(F31) Touring	320 d xDrive	120/163	2012/06-2015/07		TC00408-RI	27105A371F1; 27105A371F3		1
(F31) Touring	320 d xDrive	120/163	2015/07-		TC00414-RI	27105A371F0; 27105A371F2		2
(F31) Touring	320 d xDrive	135/184	2012/06-2015/07		TC00408-RI	27105A371F1; 27105A371F3		1
(F31) Touring	320 d xDrive	140/190	2015/07-		TC00414-RI	27105A371F0; 27105A371F2		2
(F31) Touring	320 d xDrive	147/200	2013/01-2015/07		TC00408-RI	27105A371F1; 27105A371F3		1
(F31) Touring	320 d xDrive	147/200	2015/07-		TC00414-RI	27105A371F0; 27105A371F2		2
(F31) Touring	320 i xDrive	120/163	2013/03-2015/06		TC00408-RI	27105A371F1; 27105A371F3		1
(F31) Touring	320 i xDrive	135/184	2012/06-2015/07		TC00408-RI	27105A371F1; 27105A371F3		1
(F31) Touring	320 i xDrive	135/184	2015/07-		TC00414-RI	27105A371F0; 27105A371F2		2
(F31) Touring	328 i xDrive	180/245	2012/06-2015/07		TC00408-RI	27105A371F1; 27105A371F3		1
(F31) Touring	328 i xDrive	180/245	2015/07-		TC00414-RI	27105A371F0; 27105A371F2		2
(F31) Touring	330 d xDrive	190/258	2012/06-2015/07		TC00408-RI	27105A371F1; 27105A371F3		1
(F31) Touring	330 d xDrive	190/258	2015/07-		TC00414-RI	27105A371F0; 27105A371F2		2
(F31) Touring	330 d xDrive	210/286	2015/09-		TC00414-RI	27105A371F0; 27105A371F2		2
(F31) Touring	330 i xDrive	185/252	2015/07-		TC00414-RI	27105A371F0; 27105A371F2		2
(F31) Touring	335 d xDrive	230/313	2013/09-2015/07		TC00408-RI	27105A371F1; 27105A371F3		1
(F31) Touring	335 d xDrive	230/313	2015/07-		TC00414-RI	27105A371F0; 27105A371F2		2
(F31) Touring	335 i xDrive	225/306	2013/03-2015/07		TC00408-RI	27105A371F1; 27105A371F3		1
(F31) Touring	335 i xDrive	225/306	2015/07-		TC00414-RI	27105A371F0; 27105A371F2		2
(F31) Touring	335 i xDrive	240/326	2012/01-2013/07		TC00408-RI	27105A371F1; 27105A371F3		1
(F31) Touring	335 i xDrive	250/340	2013/07-2015/07		TC00408-RI	27105A371F1; 27105A371F3		1
(F31) Touring	335 i xDrive	250/340	2015/07-		TC00414-RI	27105A371F0; 27105A371F2		2
(F31) Touring	340 i xDrive	240/326	2015/07-		TC00414-RI	27105A371F0; 27105A371F2		2
(F31) Touring	340 i xDrive	265/360	2015/07-		TC00414-RI	27105A371F0; 27105A371F2		2

All rights reserved.

This publication may not be reproduced in any form, in whole or in part, without a written approval from S-TEC Service Technologies GmbH & Co OG.  
Subject to change without notice!

### Brand - Series - Sales Name

### Maingroup - Subgroup

Salesname	Model	kW/HP	Model Year	Gearbox	Part Number	OEM Number	Info	Image
-----------	-------	-------	------------	---------	-------------	------------	------	-------

### BMW - 3 - (F34) Gran Turismo



Img.1



Img.2

### Gearbox, Powertrain - Transfer Case

(F34) Gran Turismo	320 d xDrive	120/163	2013/03-2015/07		TC00408-RI	27105A371F1; 27105A371F3		1
(F34) Gran Turismo	320 d xDrive	120/163	2015/07-		TC00414-RI	27105A371F0; 27105A371F2		2
(F34) Gran Turismo	320 d xDrive	135/184	2013/03-2015/07		TC00408-RI	27105A371F1; 27105A371F3		1
(F34) Gran Turismo	320 d xDrive	140/190	2015/07-		TC00414-RI	27105A371F0; 27105A371F2		2
(F34) Gran Turismo	320 d xDrive	140/190	2015/07-		TC00408-RI	27105A371F1; 27105A371F3		1
(F34) Gran Turismo	320 d xDrive	147/200	2013/05-2015/07		TC00408-RI	27105A371F1; 27105A371F3		1
(F34) Gran Turismo	320 d xDrive	147/200	2015/07-		TC00414-RI	27105A371F0; 27105A371F2		2
(F34) Gran Turismo	320 i xDrive	120/163	2013/03-		TC00408-RI	27105A371F1; 27105A371F3		1
(F34) Gran Turismo	320 i xDrive	120/163	2015/07-		TC00414-RI	27105A371F0; 27105A371F2		2
(F34) Gran Turismo	320 i xDrive	135/184	2013/03-2015/07		TC00408-RI	27105A371F1; 27105A371F3		1
(F34) Gran Turismo	320 i xDrive	135/184	2015/07-		TC00414-RI	27105A371F0; 27105A371F2		2
(F34) Gran Turismo	328 i xDrive	180/245	2013/03-2015/07		TC00408-RI	27105A371F1; 27105A371F3		1
(F34) Gran Turismo	328 i xDrive	180/245	2015/07-		TC00414-RI	27105A371F0; 27105A371F2		2
(F34) Gran Turismo	330 d xDrive	190/258	2014/01-2015/07		TC00408-RI	27105A371F1; 27105A371F3		1
(F34) Gran Turismo	330 d xDrive	190/258	2015/07-		TC00414-RI	27105A371F0; 27105A371F2		2
(F34) Gran Turismo	330 d xDrive	210/286	2014/01-2015/07		TC00408-RI	27105A371F1; 27105A371F3		1
(F34) Gran Turismo	330 d xDrive	210/286	2015/07-		TC00414-RI	27105A371F0; 27105A371F2		2
(F34) Gran Turismo	330 i xDrive	183/249	2016/07-		TC00408-RI	27105A371F1; 27105A371F3		1
(F34) Gran Turismo	330 i xDrive	185/252	2015/10-		TC00414-RI	27105A371F0; 27105A371F2		2
(F34) Gran Turismo	335 d xDrive	230/313	2014/01-2015/07		TC00408-RI	27105A371F1; 27105A371F3		1
(F34) Gran Turismo	335 d xDrive	230/313	2015/07-		TC00414-RI	27105A371F0; 27105A371F2		2
(F34) Gran Turismo	335 i xDrive	225/306	2013/07-2016/06		TC00408-RI	27105A371F1; 27105A371F3		1
(F34) Gran Turismo	335 i xDrive	225/306	2013/07-2016/06		TC00414-RI	27105A371F0; 27105A371F2		2
(F34) Gran Turismo	335 i xDrive	240/326	2013/03-2014/03		TC00414-RI	27105A371F0; 27105A371F2		2
(F34) Gran Turismo	335 i xDrive	250/340	2014/04-2016/06		TC00414-RI	27105A371F0; 27105A371F2		2
(F34) Gran Turismo	340 i xDrive	240/326	2015/10-		TC00414-RI	27105A371F0; 27105A371F2		2

All rights reserved.

This publication may not be reproduced in any form, in whole or in part, without a written approval from S-TEC Service Technologies GmbH & Co OG.  
Subject to change without notice!

## Brand - Series - Sales Name

### Maingroup - Subgroup

Salesname	Model	kW/HP	Model Year	Gearbox	Part Number	OEM Number	Info	Image
-----------	-------	-------	------------	---------	-------------	------------	------	-------

## BMW - 3 - (G20, G80, G28)



Img.1

### Gearbox, Powertrain - Transfer Case

(G20, G80, G28)	320 d xDrive	120/163	2018/11-2020/02		TC00555-RI	27108465870; 27108686667		1
(G20, G80, G28)	320 d xDrive	140/190	2018/11-2020/02		TC00555-RI	27108465870; 27108686667		1
(G20, G80, G28)	330 i xDrive	190/258	2018/11-		TC00555-RI	27108465870; 27108686667		1

## BMW - 3 - (G21) Touring Van



Img.1

### Gearbox, Powertrain - Transfer Case

(G21) Touring Van	320 e Plug-in-Hybrid xDrive	150/204	2021/03-		TC00569-RI	27109847753		
(G21) Touring Van	330 d xDrive	195/265	2019/11-		TC00555-RI	27108465870; 27108686667		1
(G21) Touring Van	330 i xDrive	180/245	2019/07-		TC00569-RI	27109847753		
(G21) Touring Van	M 340 d Mild-Hybrid xDrive	250/340	2020/04-		TC00569-RI	27109847753		
(G21) Touring Van	M 340 i xDrive	275/374	2019/11-		TC00555-RI	27108465870; 27108686667		1

## BMW - 3 - (G21, G81)



Img.1

### Gearbox, Powertrain - Transfer Case

(G21, G81)	330 d xDrive	195/265	2019/07-		TC00555-RI	27108465870; 27108686667		1
------------	--------------	---------	----------	--	------------	-----------------------------	--	---

All rights reserved.

This publication may not be reproduced in any form, in whole or in part, without a written approval from S-TEC Service Technologies GmbH & Co OG.  
Subject to change without notice!

### Brand - Series - Sales Name

### Maingroup - Subgroup

Salesname	Model	kW/HP	Model Year	Gearbox	Part Number	OEM Number	Info	Image
-----------	-------	-------	------------	---------	-------------	------------	------	-------

### BMW - 3 - (G21, G81) Touring



Img.1

### Gearbox, Powertrain - Transfer Case

(G21, G81) Touring	320 d xDrive	120/163	2019/07-2020/02		TC00555-RI	27108465870; 27108686667		1
(G21, G81) Touring	320 d xDrive	140/190	2019/07-2020/02		TC00555-RI	27108465870; 27108686667		1
(G21, G81) Touring	330 i xDrive	190/258	2019/07-		TC00555-RI	27108465870; 27108686667		1
(G21, G81) Touring	M 340 i xDrive	275/374	2019/11-		TC00555-RI	27108465870; 27108686667		1
(G21, G81) Touring	M 340 i xDrive	285/387	2019/11-		TC00555-RI	27108465870; 27108686667		1

All rights reserved.

This publication may not be reproduced in any form, in whole or in part, without a written approval from S-TEC Service Technologies GmbH & Co OG.  
Subject to change without notice!

## Brand - Series - Sales Name

### Maingroup - Subgroup

Salesname	Model	kW/HP	Model Year	Gearbox	Part Number	OEM Number	Info	Image
-----------	-------	-------	------------	---------	-------------	------------	------	-------

## BMW - 4 - (F32, F82) Coupe



Img.1



Img.2

### Gearbox, Powertrain - Transfer Case

(F32, F82) Coupe	420 d xDrive	120/163	2013/11-2015/07		TC00408-RI	27105A371F1; 27105A371F3		1
(F32, F82) Coupe	420 d xDrive	120/163	2015/07-		TC00414-RI	27105A371F0; 27105A371F2		2
(F32, F82) Coupe	420 d xDrive	135/184	2013/11-2015/03		TC00408-RI	27105A371F1; 27105A371F3		1
(F32, F82) Coupe	420 d xDrive	140/190	2015/03-2015/07		TC00408-RI	27105A371F1; 27105A371F3		1
(F32, F82) Coupe	420 d xDrive	140/190	2015/07-		TC00414-RI	27105A371F0; 27105A371F2		2
(F32, F82) Coupe	420 d xDrive	147/200	2013/11-2015/03		TC00408-RI	27105A371F1; 27105A371F3		1
(F32, F82) Coupe	420 i xDrive	120/163	2013/11-2020/06		TC00408-RI	27105A371F1; 27105A371F3		1
(F32, F82) Coupe	420 i xDrive	120/163	2015/07-		TC00414-RI	27105A371F0; 27105A371F2		2
(F32, F82) Coupe	420 i xDrive	135/184	2013/11-2015/07		TC00408-RI	27105A371F1; 27105A371F3		1
(F32, F82) Coupe	420 i xDrive	135/184	2015/07-		TC00414-RI	27105A371F0; 27105A371F2		2
(F32, F82) Coupe	428 i xDrive	180/245	2013/07-2015/07		TC00408-RI	27105A371F1; 27105A371F3		1
(F32, F82) Coupe	428 i xDrive	180/245	2015/07-		TC00414-RI	27105A371F0; 27105A371F2		2
(F32, F82) Coupe	430 d xDrive	190/258	2014/01-2015/07		TC00408-RI	27105A371F1; 27105A371F3		1
(F32, F82) Coupe	430 d xDrive	210/286	2013/11-2015/07		TC00408-RI	27105A371F1; 27105A371F3		1
(F32, F82) Coupe	430 i xDrive	185/252	2016/03-		TC00414-RI	27105A371F0; 27105A371F2		2
(F32, F82) Coupe	435 d xDrive	230/313	2013/11-2015/07		TC00408-RI	27105A371F1; 27105A371F3		1
(F32, F82) Coupe	435 i xDrive	225/306	2013/07-2015/07		TC00408-RI	27105A371F1; 27105A371F3		1
(F32, F82) Coupe	435 i xDrive	250/340	2013/07-2015/07		TC00408-RI	27105A371F1; 27105A371F3		1
(F32, F82) Coupe	435 i xDrive	250/340	2015/07-		TC00414-RI	27105A371F0; 27105A371F2		2
(F32, F82) Coupe	440 i xDrive	240/326	2016/03-		TC00414-RI	27105A371F0; 27105A371F2		2
(F32, F82) Coupe	440 i xDrive	265/360	2016/03-		TC00414-RI	27105A371F0; 27105A371F2		2

All rights reserved.

This publication may not be reproduced in any form, in whole or in part, without a written approval from S-TEC Service Technologies GmbH & Co OG.  
Subject to change without notice!

### Brand - Series - Sales Name

### Maingroup - Subgroup

Salesname	Model	kW/HP	Model Year	Gearbox	Part Number	OEM Number	Info	Image
-----------	-------	-------	------------	---------	-------------	------------	------	-------

### BMW - 4 - (F33, F83) Cabriolet



Img.1



Img.2

### Gearbox, Powertrain - Transfer Case

(F33, F83) Cabriolet	428 i xDrive	180/245	2014/01-2015/07		TC00408-RI	27105A371F1; 27105A371F3		1
(F33, F83) Cabriolet	428 i xDrive	180/245	2015/07-		TC00414-RI	27105A371F0; 27105A371F2		2
(F33, F83) Cabriolet	430 i xDrive	185/252	2016/03-		TC00414-RI	27105A371F0; 27105A371F2		2
(F33, F83) Cabriolet	435 d xDrive	230/313	2014/07-2015/07		TC00408-RI	27105A371F1; 27105A371F3		1
(F33, F83) Cabriolet	435 d xDrive	230/313	2015/07-		TC00414-RI	27105A371F0; 27105A371F2		2
(F33, F83) Cabriolet	435 i xDrive	225/306	2014/07-2015/07		TC00408-RI	27105A371F1; 27105A371F3		1
(F33, F83) Cabriolet	435 i xDrive	225/306	2015/07-		TC00414-RI	27105A371F0; 27105A371F2		2
(F33, F83) Cabriolet	435 i xDrive	250/340	2014/07-2015/07		TC00408-RI	27105A371F1; 27105A371F3		1
(F33, F83) Cabriolet	435 i xDrive	250/340	2015/07-		TC00414-RI	27105A371F0; 27105A371F2		2
(F33, F83) Cabriolet	440 i xDrive	240/326	2016/03-		TC00414-RI	27105A371F0; 27105A371F2		2
(F33, F83) Cabriolet	440 i xDrive	265/360	2016/03-		TC00414-RI	27105A371F0; 27105A371F2		2

All rights reserved.

This publication may not be reproduced in any form, in whole or in part, without a written approval from S-TEC Service Technologies GmbH & Co OG.  
Subject to change without notice!

### Brand - Series - Sales Name

### Maingroup - Subgroup

Salesname	Model	kW/HP	Model Year	Gearbox	Part Number	OEM Number	Info	Image
-----------	-------	-------	------------	---------	-------------	------------	------	-------

### BMW - 4 - (F36) Gran Coupe



Img.1



Img.2

### Gearbox, Powertrain - Transfer Case

(F36) Gran Coupe	420 d xDrive	120/163	2014/03-2015/07		TC00408-RI	27105A371F1; 27105A371F3		1
(F36) Gran Coupe	420 d xDrive	120/163	2015/03-		TC00414-RI	27105A371F0; 27105A371F2		2
(F36) Gran Coupe	420 d xDrive	135/184	2014/03-2015/03		TC00408-RI	27105A371F1; 27105A371F3		1
(F36) Gran Coupe	420 d xDrive	140/190	2015/03-2015/07		TC00408-RI	27105A371F1; 27105A371F3		1
(F36) Gran Coupe	420 d xDrive	140/190	2015/07-		TC00414-RI	27105A371F0; 27105A371F2		2
(F36) Gran Coupe	420 d xDrive	147/200	2014/03-2015/03		TC00408-RI	27105A371F1; 27105A371F3		1
(F36) Gran Coupe	420 i xDrive	120/163	2014/03-2021/05		TC00408-RI	27105A371F1; 27105A371F3		1
(F36) Gran Coupe	420 i xDrive	120/163	2015/03-		TC00414-RI	27105A371F0; 27105A371F2		2
(F36) Gran Coupe	420 i xDrive	135/184	2014/07-2015/07		TC00408-RI	27105A371F1; 27105A371F3		1
(F36) Gran Coupe	420 i xDrive	135/184	2015/07-		TC00414-RI	27105A371F0; 27105A371F2		2
(F36) Gran Coupe	428 i xDrive	180/245	2014/03-2015/07		TC00408-RI	27105A371F1; 27105A371F3		1
(F36) Gran Coupe	428 i xDrive	180/245	2015/03-		TC00414-RI	27105A371F0; 27105A371F2		2
(F36) Gran Coupe	430 d xDrive	190/258	2014/07-2015/07		TC00408-RI	27105A371F1; 27105A371F3		1
(F36) Gran Coupe	430 d xDrive	190/258	2015/07-		TC00414-RI	27105A371F0; 27105A371F2		2
(F36) Gran Coupe	430 d xDrive	210/286	2014/07-2015/07		TC00408-RI	27105A371F1; 27105A371F3		1
(F36) Gran Coupe	430 d xDrive	210/286	2015/07-		TC00414-RI	27105A371F0; 27105A371F2		2
(F36) Gran Coupe	430 i xDrive	185/252	2016/03-		TC00414-RI	27105A371F0; 27105A371F2		2
(F36) Gran Coupe	435 d xDrive	230/313	2014/07-2015/07		TC00408-RI	27105A371F1; 27105A371F3		1
(F36) Gran Coupe	435 d xDrive	230/313	2015/07-		TC00414-RI	27105A371F0; 27105A371F2		2
(F36) Gran Coupe	435 i xDrive	225/306	2014/07-2015/07		TC00408-RI	27105A371F1; 27105A371F3		1
(F36) Gran Coupe	435 i xDrive	250/340	2014/07-2015/07		TC00408-RI	27105A371F1; 27105A371F3		1
(F36) Gran Coupe	440 i xDrive	240/326	2016/03-		TC00414-RI	27105A371F0; 27105A371F2		2
(F36) Gran Coupe	440 i xDrive	265/360	2016/03-		TC00414-RI	27105A371F0; 27105A371F2		2

All rights reserved.

This publication may not be reproduced in any form, in whole or in part, without a written approval from S-TEC Service Technologies GmbH & Co OG.  
Subject to change without notice!



### Brand - Series - Sales Name

### Maingroup - Subgroup

Salesname	Model	kW/HP	Model Year	Gearbox	Part Number	OEM Number	Info	Image
-----------	-------	-------	------------	---------	-------------	------------	------	-------

### BMW - 4 - (G22, G82) Coupe

#### Gearbox, Powertrain - Transfer Case

(G22, G82) Coupe	420 d Mild-Hybrid xDrive	140/190	2020/07-		TC00569-RI	27109847753		
(G22, G82) Coupe	420 i xDrive	135/184	2021/07-		TC00569-RI	27109847753		
(G22, G82) Coupe	430 d Mild-Hybrid xDrive	210/286	2021/03-		TC00569-RI	27109847753		
(G22, G82) Coupe	430 i xDrive	180/245	2021/07-		TC00569-RI	27109847753		
(G22, G82) Coupe	430 i xDrive	190/258	2021/07-		TC00569-RI	27109847753		
(G22, G82) Coupe	M 440 i Mild-Hybrid xDrive	275/374	2020/11-		TC00569-RI	27109847753		
(G22, G82) Coupe	M 440 i Mild-Hybrid xDrive	285/387	2020/07-		TC00569-RI	27109847753		
(G22, G82) Coupe	M440 d Mild-Hybrid xDrive	250/340	2021/03-		TC00569-RI	27109847753		

### BMW - 5 - (E60)



Img.1

#### Gearbox, Powertrain - Transfer Case

(E60)	525 d xDrive	145/197	2008/09-2010/03		TC00035-RI	27107599690; 27107599693		1
(E60)	525 i xDrive	160/218	2008/09-2010/03		TC00035-RI	27107599690; 27107599693		1
(E60)	525 xd	145/197	2007/01-2010/03		TC00035-RI	27107599690; 27107599693		1
(E60)	525 xi	160/218	2005/07-2010/03		TC00035-RI	27107599690; 27107599693		1
(E60)	528 i xDrive	171/233	2007/09-2010/03		TC00035-RI	27107599690; 27107599693		1
(E60)	530 d xDrive	173/235	2008/09-2010/03		TC00035-RI	27107599690; 27107599693		1
(E60)	530 i xDrive	200/272	2008/09-2010/03		TC00035-RI	27107599690; 27107599693		1
(E60)	530 xd	170/231	2005/07-2010/03		TC00035-RI	27107599690; 27107599693		1
(E60)	530 xd	173/235	2007/01-2010/03		TC00035-RI	27107599690; 27107599693		1
(E60)	530 xi	190/258	2005/07-2010/03		TC00035-RI	27107599690; 27107599693		1
(E60)	530 xi	200/272	2007/01-2010/03		TC00035-RI	27107599690; 27107599693		1
(E60)	535 i xDrive	224/305	2008/09-2010/03		TC00035-RI	27107599690; 27107599693		1
(E60)	535 ix	224/305	2008/09-2009/12		TC00035-RI	27107599690; 27107599693		1

All rights reserved.

This publication may not be reproduced in any form, in whole or in part, without a written approval from S-TEC Service Technologies GmbH & Co OG.  
Subject to change without notice!

## Brand - Series - Sales Name

### Maingroup - Subgroup

Salesname	Model	kW/HP	Model Year	Gearbox	Part Number	OEM Number	Info	Image
-----------	-------	-------	------------	---------	-------------	------------	------	-------

## BMW - 5 - (E61) Touring



Img.1

### Gearbox, Powertrain - Transfer Case

(E61) Touring	525 d xDrive	145/197	2008/09-2010/12		TC00035-RI	27107599690; 27107599693		1
(E61) Touring	525 i xDrive	160/218	2008/09-2010/12		TC00035-RI	27107599690; 27107599693		1
(E61) Touring	525 xd	145/197	2007/01-2010/12		TC00035-RI	27107599690; 27107599693		1
(E61) Touring	525 xi	160/218	2005/07-2010/12		TC00035-RI	27107599690; 27107599693		1
(E61) Touring	530 d xDrive	173/235	2008/09-2010/12		TC00035-RI	27107599690; 27107599693		1
(E61) Touring	530 i xDrive	200/272	2008/09-2010/12		TC00035-RI	27107599690; 27107599693		1
(E61) Touring	530 xd	170/231	2005/07-2010/12		TC00035-RI	27107599690; 27107599693		1
(E61) Touring	530 xd	173/235	2007/01-2010/12		TC00035-RI	27107599690; 27107599693		1
(E61) Touring	530 xi	190/258	2005/07-2010/12		TC00035-RI	27107599690; 27107599693		1
(E61) Touring	530 xi	200/272	2007/01-2010/12		TC00035-RI	27107599690; 27107599693		1
(E61) Touring	535 xi	224/305	2007/09-2010/12		TC00035-RI	27107599690; 27107599693		1

All rights reserved.

This publication may not be reproduced in any form, in whole or in part, without a written approval from S-TEC Service Technologies GmbH & Co OG.  
Subject to change without notice!

### Brand - Series - Sales Name

### Maingroup - Subgroup

Salesname	Model	kW/HP	Model Year	Gearbox	Part Number	OEM Number	Info	Image
-----------	-------	-------	------------	---------	-------------	------------	------	-------

### BMW - 5 - (F07) Gran Turismo



Img.1



Img.2

### Gearbox, Powertrain - Transfer Case

(F07) Gran Turismo	530 d xDrive	180/245	2010/09-2012/05		TC00267-RI	27105A371E7		1
(F07) Gran Turismo	530 d xDrive	180/245	2012/06-		TC00414-RI	27105A371F0; 27105A371F2		2
(F07) Gran Turismo	530 d xDrive	190/258	2009/10-2012/05		TC00267-RI	27105A371E7		1
(F07) Gran Turismo	530 d xDrive	190/258	2012/06-		TC00414-RI	27105A371F0; 27105A371F2		2
(F07) Gran Turismo	535 d xDrive	220/299	2010/09-2012/05		TC00267-RI	27105A371E7		1
(F07) Gran Turismo	535 d xDrive	220/299	2012/06-		TC00414-RI	27105A371F0; 27105A371F2		2
(F07) Gran Turismo	535 d xDrive	230/313	2012/06-		TC00414-RI	27105A371F0; 27105A371F2		2
(F07) Gran Turismo	535 i xDrive	225/306	2010/09-2012/05		TC00267-RI	27105A371E7		1
(F07) Gran Turismo	535 i xDrive	225/306	2012/06-		TC00414-RI	27105A371F0; 27105A371F2		2
(F07) Gran Turismo	550 i xDrive	298/405	2010/09-2012/06		TC00267-RI	27105A371E7		1
(F07) Gran Turismo	550 i xDrive	300/408	2009/04-2012/06		TC00267-RI	27105A371E7		1
(F07) Gran Turismo	550 i xDrive	300/408	2012/06-		TC00414-RI	27105A371F0; 27105A371F2		2
(F07) Gran Turismo	550 i xDrive	330/449	2011/04-2012/05		TC00267-RI	27105A371E7		1
(F07) Gran Turismo	550 i xDrive	330/449	2012/06-		TC00414-RI	27105A371F0; 27105A371F2		2

All rights reserved.

This publication may not be reproduced in any form, in whole or in part, without a written approval from S-TEC Service Technologies GmbH & Co OG.  
Subject to change without notice!

### Brand - Series - Sales Name

### Maingroup - Subgroup

Salesname	Model	kW/HP	Model Year	Gearbox	Part Number	OEM Number	Info	Image
-----------	-------	-------	------------	---------	-------------	------------	------	-------

### BMW - 5 - (F10)



Img.1



Img.2



Img.3

### Gearbox, Powertrain - Transfer Case

(F10)	520 d xDrive	120/163	2013/02-		TC00408-RI	27105A371F1; 27105A371F3		1
(F10)	520 d xDrive	135/184	2013/02-		TC00408-RI	27105A371F1; 27105A371F3		1
(F10)	520 d xDrive	140/190	2014/07-		TC00414-RI	27105A371F0; 27105A371F2		2
(F10)	520 d xDrive	155/211	2013/10-2016/10		TC00408-RI	27105A371F1; 27105A371F3		1
(F10)	525 d xDrive	155/211	2011/09-		TC00408-RI	27105A371F1; 27105A371F3		1
(F10)	525 d xDrive	160/218	2011/09-		TC00408-RI	27105A371F1; 27105A371F3		1
(F10)	528 i xDrive	180/245	2011/09-		TC00408-RI	27105A371F1; 27105A371F3		1
(F10)	530 d xDrive	190/258	2011/09-		TC00414-RI	27105A371F0; 27105A371F2		2
(F10)	530 d xDrive	210/286	2015/10-		TC00414-RI	27105A371F0; 27105A371F2		2
(F10)	535 d xDrive	230/313	2011/09-		TC00414-RI	27105A371F0; 27105A371F2		2
(F10)	535 i xDrive	225/306	2011/03-2011/09		TC00267-RI	27105A371E7		3
(F10)	535 i xDrive	225/306	2011/09-		TC00414-RI	27105A371F0; 27105A371F2		2
(F10)	535 i xDrive	240/326	2013/07-		TC00414-RI	27105A371F0; 27105A371F2		2
(F10)	550 i xDrive	298/405	2012/09-		TC00414-RI	27105A371F0; 27105A371F2		2
(F10)	550 i xDrive	300/408	2010/08-2011/09		TC00267-RI	27105A371E7		3
(F10)	550 i xDrive	300/408	2011/09-		TC00414-RI	27105A371F0; 27105A371F2		2
(F10)	550 i xDrive	330/449	2013/05-		TC00414-RI	27105A371F0; 27105A371F2		2
(F10)	550 i xDrive	332/452	2013/07-		TC00414-RI	27105A371F0; 27105A371F2		2
(F10)	M 550 d xDrive	280/381	2012/01-		TC00414-RI	27105A371F0; 27105A371F2		2

All rights reserved.

This publication may not be reproduced in any form, in whole or in part, without a written approval from S-TEC Service Technologies GmbH & Co OG.  
Subject to change without notice!

## Brand - Series - Sales Name

### Maingroup - Subgroup

Salesname	Model	kW/HP	Model Year	Gearbox	Part Number	OEM Number	Info	Image
-----------	-------	-------	------------	---------	-------------	------------	------	-------

## BMW - 5 - (F11) Touring



Img.1



Img.2



Img.3

### Gearbox, Powertrain - Transfer Case

(F11) Touring	520 d xDrive	120/163	2013/02-		TC00408-RI	27105A371F1; 27105A371F3		1
(F11) Touring	520 d xDrive	135/184	2013/02-		TC00408-RI	27105A371F1; 27105A371F3		1
(F11) Touring	520 d xDrive	140/190	2014/05-		TC00414-RI	27105A371F0; 27105A371F2		2
(F11) Touring	525 d xDrive	155/211	2011/09-		TC00408-RI	27105A371F1; 27105A371F3		1
(F11) Touring	525 d xDrive	160/218	2011/09-		TC00408-RI	27105A371F1; 27105A371F3		1
(F11) Touring	528 i xDrive	180/245	2011/09-		TC00408-RI	27105A371F1; 27105A371F3		1
(F11) Touring	530 d xDrive	190/258	2011/09-		TC00414-RI	27105A371F0; 27105A371F2		2
(F11) Touring	530 d xDrive	210/286	2015/10-		TC00414-RI	27105A371F0; 27105A371F2		2
(F11) Touring	535 d xDrive	230/313	2011/09-		TC00414-RI	27105A371F0; 27105A371F2		2
(F11) Touring	535 i xDrive	190/258	2010/07-2011/09		TC00267-RI	27105A371E7		3
(F11) Touring	535 i xDrive	225/306	2011/09-		TC00414-RI	27105A371F0; 27105A371F2		2
(F11) Touring	535 i xDrive	240/326	2015/10-		TC00414-RI	27105A371F0; 27105A371F2		2
(F11) Touring	M 550 d xDrive	280/381	2012/01-		TC00414-RI	27105A371F0; 27105A371F2		2

All rights reserved.

This publication may not be reproduced in any form, in whole or in part, without a written approval from S-TEC Service Technologies GmbH & Co OG.  
Subject to change without notice!

## Brand - Series - Sales Name

### Maingroup - Subgroup

Salesname	Model	kW/HP	Model Year	Gearbox	Part Number	OEM Number	Info	Image
-----------	-------	-------	------------	---------	-------------	------------	------	-------

## BMW - 5 - (G30, F90)



Img.1



Img.2

### Gearbox, Powertrain - Transfer Case

(G30, F90)	520 d xDrive	120/163	2016/09-		TC00555-RI	27108465870; 27108686667		1
(G30, F90)	520 d xDrive	140/190	2016/09-		TC00555-RI	27108465870; 27108686667		1
(G30, F90)	530 d xDrive	183/249	2016/09-2020/06		TC00555-RI	27108465870; 27108686667		1
(G30, F90)	530 d xDrive	195/265	2016/09-2020/06		TC00555-RI	27108465870; 27108686667		1
(G30, F90)	530 i xDrive	185/252	2016/09-2022/12		TC00555-RI	27108465870; 27108686667		1
(G30, F90)	540 d xDrive	235/320	2017/07-2020/06		TC00555-RI	27108465870; 27108686667		1
(G30, F90)	540 i xDrive	250/340	2016/09-2022/12		TC00555-RI	27108465870; 27108686667		1
(G30, F90)	540 i xDrive	265/360	2016/09-2020/06		TC00555-RI	27108465870; 27108686667		1
(G30, F90)	M 550 d xDrive	294/400	2017/06-		TC00555-RI	27108465870; 27108686667		1
(G30, F90)	M 550 i xDrive	340/462	2017/03-2019/06		TC00556-RI	27108465871; 27108686666		2
(G30, F90)	M 550 i xDrive	340/462	2017/03-2019/06		TC00555-RI	27108465870; 27108686667		1
(G30, F90)	M 550 i xDrive	390/530	2019/07-		TC00556-RI	27108465871; 27108686666		2
(G30, F90)	M 550 i xDrive	390/530	2019/07-		TC00555-RI	27108465870; 27108686667		1
(G30, F90)	M5 CS	467/635	2021/03-		TC00557-RI	27108747764		
(G30, F90)	M5 Competition	460/625	2018/07-		TC00557-RI	27108747764		
(G30, F90)	M5	441/600	2017/09-		TC00557-RI	27108747764		

## BMW - 5 - (G31)



Img.1

### Gearbox, Powertrain - Transfer Case

(G31)	520 d xDrive	120/163	2017/07-		TC00555-RI	27108465870; 27108686667		1
-------	--------------	---------	----------	--	------------	-----------------------------	--	---

All rights reserved.

This publication may not be reproduced in any form, in whole or in part, without a written approval from S-TEC Service Technologies GmbH & Co OG.  
Subject to change without notice!

## Brand - Series - Sales Name

### Maingroup - Subgroup

Salesname	Model	kW/HP	Model Year	Gearbox	Part Number	OEM Number	Info	Image
-----------	-------	-------	------------	---------	-------------	------------	------	-------

## BMW - 5 - (G31) Touring



Img.1

### Gearbox, Powertrain - Transfer Case

(G31) Touring	520 d xDrive	140/190	2017/07-		TC00555-RI	27108465870; 27108686667		1
(G31) Touring	530 d xDrive	195/265	2017/03-2020/06		TC00555-RI	27108465870; 27108686667		1
(G31) Touring	530 i xDrive	185/252	2017/07-2020/06		TC00555-RI	27108465870; 27108686667		1
(G31) Touring	540 i xDrive	250/340	2017/03-2020/06		TC00555-RI	27108465870; 27108686667		1
(G31) Touring	540 i xDrive	265/360	2017/03-2020/06		TC00555-RI	27108465870; 27108686667		1

## BMW - 5 - (G31) Touring Van



Img.1

### Gearbox, Powertrain - Transfer Case

(G31) Touring Van	530 d xDrive	195/265	2017/03-		TC00555-RI	27108465870; 27108686667		1
(G31) Touring Van	530 i xDrive	185/252	2017/07-		TC00555-RI	27108465870; 27108686667		1
(G31) Touring Van	540 i xDrive	250/340	2017/03-		TC00555-RI	27108465870; 27108686667		1

## BMW - 6 - (F06) Gran Coupe



Img.1

### Gearbox, Powertrain - Transfer Case

(F06) Gran Coupe	640 d xDrive	230/313	2015/03-		TC00414-RI	27105A371F0; 27105A371F2		1
(F06) Gran Coupe	640 i xDrive	235/320	2015/03-		TC00414-RI	27105A371F0; 27105A371F2		1
(F06) Gran Coupe	650 i xDrive	300/408	2015/03-		TC00414-RI	27105A371F0; 27105A371F2		1
(F06) Gran Coupe	650 i xDrive	330/449	2015/03-		TC00414-RI	27105A371F0; 27105A371F2		1
(F06) Gran Coupe	650 i xDrive	332/452	2015/03-		TC00414-RI	27105A371F0; 27105A371F2		1
(F06) Gran Coupe	650 i xDrive	335/456	2015/03-		TC00414-RI	27105A371F0; 27105A371F2		1

All rights reserved.

This publication may not be reproduced in any form, in whole or in part, without a written approval from S-TEC Service Technologies GmbH & Co OG.  
Subject to change without notice!

## Brand - Series - Sales Name

### Maingroup - Subgroup

Salesname	Model	kW/HP	Model Year	Gearbox	Part Number	OEM Number	Info	Image
-----------	-------	-------	------------	---------	-------------	------------	------	-------

## BMW - 6 - (F12) Cabriolet



Img.1

### Gearbox, Powertrain - Transfer Case

(F12) Cabriolet	640 d xDrive	230/313	2015/03-		TC00414-RI	27105A371F0; 27105A371F2		1
(F12) Cabriolet	640 i xDrive	235/320	2015/03-		TC00414-RI	27105A371F0; 27105A371F2		1
(F12) Cabriolet	650 i xDrive	298/405	2015/03-		TC00414-RI	27105A371F0; 27105A371F2		1
(F12) Cabriolet	650 i xDrive	300/407	2015/03-		TC00414-RI	27105A371F0; 27105A371F2		1
(F12) Cabriolet	650 i xDrive	300/408	2015/03-		TC00414-RI	27105A371F0; 27105A371F2		1
(F12) Cabriolet	650 i xDrive	330/449	2015/03-		TC00414-RI	27105A371F0; 27105A371F2		1
(F12) Cabriolet	650 i xDrive	332/452	2015/03-		TC00414-RI	27105A371F0; 27105A371F2		1

## BMW - 6 - (F13) Coupe



Img.1

### Gearbox, Powertrain - Transfer Case

(F13) Coupe	640 d xDrive	230/313	2015/03-		TC00414-RI	27105A371F0; 27105A371F2		1
(F13) Coupe	640 i xDrive	235/320	2015/03-		TC00414-RI	27105A371F0; 27105A371F2		1
(F13) Coupe	650 i xDrive	298/405	2015/03-		TC00414-RI	27105A371F0; 27105A371F2		1
(F13) Coupe	650 i xDrive	300/408	2015/03-		TC00414-RI	27105A371F0; 27105A371F2		1
(F13) Coupe	650 i xDrive	330/449	2015/03-		TC00414-RI	27105A371F0; 27105A371F2		1
(F13) Coupe	650 i xDrive	332/452	2015/03-		TC00414-RI	27105A371F0; 27105A371F2		1

All rights reserved.

This publication may not be reproduced in any form, in whole or in part, without a written approval from S-TEC Service Technologies GmbH & Co OG.  
Subject to change without notice!



### Brand - Series - Sales Name

### Maingroup - Subgroup

Salesname	Model	kW/HP	Model Year	Gearbox	Part Number	OEM Number	Info	Image
-----------	-------	-------	------------	---------	-------------	------------	------	-------

### BMW - 6 - (G32) Gran Turismo



Img.1

### Gearbox, Powertrain - Transfer Case

(G32) Gran Turismo	620 d xDrive	120/163	2018/07-2020/06		TC00555-RI	27108465870; 27108686667		1
(G32) Gran Turismo	620 d xDrive	140/190	2018/07-2020/06		TC00555-RI	27108465870; 27108686667		1
(G32) Gran Turismo	630 d xDrive	155/211	2017/06-2020/06		TC00555-RI	27108465870; 27108686667		1
(G32) Gran Turismo	630 d xDrive	183/249	2017/06-2020/06		TC00555-RI	27108465870; 27108686667		1
(G32) Gran Turismo	630 d xDrive	195/265	2017/06-2020/06		TC00555-RI	27108465870; 27108686667		1
(G32) Gran Turismo	640 d xDrive	235/320	2017/11-2020/06		TC00555-RI	27108465870; 27108686667		1
(G32) Gran Turismo	640 i xDrive	250/340	2017/06-2020/06		TC00555-RI	27108465870; 27108686667		1
(G32) Gran Turismo	640 i xDrive	265/360	2017/06-2020/06		TC00555-RI	27108465870; 27108686667		1

### BMW - 7 - (F01, F02, F03, F04)



Img.1



Img.2

### Gearbox, Powertrain - Transfer Case

(F01, F02, F03, F04)	730 d xDrive	190/258	2012/07-2015/12		TC00414-RI	27105A371F0; 27105A371F2		1
(F01, F02, F03, F04)	740 d xDrive	225/306	2009/09-2015/12		TC00267-RI	27105A371E7		2
(F01, F02, F03, F04)	740 d xDrive	230/313	2012/07-2015/12		TC00267-RI	27105A371E7		2
(F01, F02, F03, F04)	740 i, Li xDrive	235/320	2012/07-2015/12		TC00414-RI	27105A371F0; 27105A371F2		1
(F01, F02, F03, F04)	750 Li xDrive	298/405	2008/09-2015/12		TC00267-RI	27105A371E7		2
(F01, F02, F03, F04)	750 d xDrive	280/381	2012/07-2015/12		TC00414-RI	27105A371F0; 27105A371F2		1
(F01, F02, F03, F04)	750 i xDrive	300/408	2009/09-2015/12		TC00267-RI	27105A371E7		2
(F01, F02, F03, F04)	750 i xDrive	330/449	2012/10-2015/12		TC00414-RI	27105A371F0; 27105A371F2		1
(F01, F02, F03, F04)	750 i xDrive	331/450	2012/09-2015/12		TC00414-RI	27105A371F0; 27105A371F2		1

All rights reserved.

This publication may not be reproduced in any form, in whole or in part, without a written approval from S-TEC Service Technologies GmbH & Co OG.  
Subject to change without notice!

### Brand - Series - Sales Name

### Maingroup - Subgroup

Salesname	Model	kW/HP	Model Year	Gearbox	Part Number	OEM Number	Info	Image
-----------	-------	-------	------------	---------	-------------	------------	------	-------

### BMW - 7 - (G11, G12)



Img.1



Img.2

### Gearbox, Powertrain - Transfer Case

(G11, G12)	730 d Mild-Hybrid xDrive	155/211	2020/07-		TC00556-RI	27108465871; 27108686666		1
(G11, G12)	730 d xDrive	155/211	2015/09-2020/06		TC00556-RI	27108465871; 27108686666		1
(G11, G12)	730 d xDrive	155/211	2015/09-2020/06		TC00555-RI	27108465870; 27108686667		2
(G11, G12)	730 d, Ld Mild-Hybrid xDrive	183/249	2020/07-		TC00556-RI	27108465871; 27108686666		1
(G11, G12)	730 d, Ld Mild-Hybrid xDrive	210/286	2020/07-		TC00556-RI	27108465871; 27108686666		1
(G11, G12)	730 d, Ld Mild-Hybrid	210/286	2020/07-		TC00556-RI	27108465871; 27108686666		1
(G11, G12)	730 d, Ld xDrive	183/249	2015/09-2020/06		TC00556-RI	27108465871; 27108686666		1
(G11, G12)	730 d, Ld xDrive	183/249	2015/09-2020/06		TC00555-RI	27108465870; 27108686667		2
(G11, G12)	730 d, Ld xDrive	195/265	2015/09-2020/06		TC00555-RI	27108465870; 27108686667		2
(G11, G12)	730 d, Ld xDrive	195/265	2015/09-2020/06		TC00556-RI	27108465871; 27108686666		1
(G11, G12)	730 d	155/211	2015/07-2020/06		TC00556-RI	27108465871; 27108686666		1
(G11, G12)	730 d	195/265	2015/09-2020/06		TC00556-RI	27108465871; 27108686666		1
(G11, G12)	740 Le xDrive	190/258	2016/07-2019/02		TC00555-RI	27108465870; 27108686667		2
(G11, G12)	740 Le xDrive	240/326	2016/07-2019/02		TC00555-RI	27108465870; 27108686667		2
(G11, G12)	740 Li xDrive	250/340	2019/03-		TC00555-RI	27108465870; 27108686667		2
(G11, G12)	740 Li xDrive	250/340	2019/03-		TC00556-RI	27108465871; 27108686666		1
(G11, G12)	740 d, Ld Mild-Hybrid xDrive	250/340	2020/07-		TC00556-RI	27108465871; 27108686666		1
(G11, G12)	740 d, Ld xDrive	235/320	2015/11-2020/06		TC00556-RI	27108465871; 27108686666		1
(G11, G12)	740 i, Li	240/326	2015/07-2019/02		TC00556-RI	27108465871; 27108686666		1
(G11, G12)	740 i, Li	250/340	2019/03-		TC00556-RI	27108465871; 27108686666		1
(G11, G12)	745 Le Plug-in-Hybrid xDrive	210/286	2019/03-		TC00556-RI	27108465871; 27108686666		1
(G11, G12)	745 Le Plug-in-Hybrid xDrive	290/394	2019/03-		TC00556-RI	27108465871; 27108686666		1
(G11, G12)	745 e, Le Plug-in-Hybrid	210/286	2019/03-		TC00556-RI	27108465871; 27108686666		1
(G11, G12)	745 e, Le Plug-in-Hybrid	290/394	2019/03-		TC00556-RI	27108465871; 27108686666		1
(G11, G12)	750 Li xDrive	330/449	2016/03-2019/02		TC00556-RI	27108465871; 27108686666		1
(G11, G12)	750 Li xDrive	330/449	2016/03-2019/02		TC00555-RI	27108465870; 27108686667		2
(G11, G12)	750 d, Ld xDrive	294/400	2016/07-		TC00556-RI	27108465871; 27108686666		1
(G11, G12)	750 i, Li xDrive	330/449	2015/09-2019/02		TC00555-RI	27108465870; 27108686667		2

All rights reserved.

This publication may not be reproduced in any form, in whole or in part, without a written approval from S-TEC Service Technologies GmbH & Co OG.  
Subject to change without notice!

### Brand - Series - Sales Name

### Maingroup - Subgroup

Salesname	Model	kW/HP	Model Year	Gearbox	Part Number	OEM Number	Info	Image
-----------	-------	-------	------------	---------	-------------	------------	------	-------

### BMW - 7 - (G11, G12)

#### Gearbox, Powertrain - Transfer Case

(G11, G12)	750 i, Li xDrive	330/449	2015/09-2019/02		TC00556-RI	27108465871; 27108686666		1
(G11, G12)	750 i, Li xDrive	390/530	2019/03-		TC00555-RI	27108465870; 27108686667		2
(G11, G12)	750 i, Li xDrive	390/530	2019/03-		TC00556-RI	27108465871; 27108686666		1
(G11, G12)	750 i, Li	330/449	2015/11-2019/02		TC00556-RI	27108465871; 27108686666		1
(G11, G12)	M 760 Li xDrive	430/585	2019/03-		TC00556-RI	27108465871; 27108686666		1
(G11, G12)	M 760 i, Li xDrive	448/610	2016/12-2019/02		TC00556-RI	27108465871; 27108686666		1

### BMW - 8 - (G11, G12)



Img.1

#### Gearbox, Powertrain - Transfer Case

(G11, G12)	740 Li xDrive	240/326	2016/03-2019/02		TC00556-RI	27108465871; 27108686666		1
------------	---------------	---------	-----------------	--	------------	-----------------------------	--	---

### BMW - 8 - (G14, F91) Cabriolet



Img.1



Img.2

#### Gearbox, Powertrain - Transfer Case

(G14, F91) Cabriolet	840 d Mild-Hybrid xDrive	250/340	2020/11-		TC00556-RI	27108465871; 27108686666		1
(G14, F91) Cabriolet	840 d xDrive	235/320	2018/11-2020/10		TC00556-RI	27108465871; 27108686666		1
(G14, F91) Cabriolet	840 i xDrive	245/333	2020/11-		TC00555-RI	27108465870; 27108686667		2
(G14, F91) Cabriolet	840 i xDrive	250/340	2019/07-2020/10		TC00555-RI	27108465870; 27108686667		2
(G14, F91) Cabriolet	M 850 i xDrive	390/530	2018/11-		TC00556-RI	27108465871; 27108686666		1
(G14, F91) Cabriolet	M8 Competition	460/625	2019/07-		TC00557-RI	27108747764		
(G14, F91) Cabriolet	M8	441/600	2019/07-		TC00557-RI	27108747764		

All rights reserved.

This publication may not be reproduced in any form, in whole or in part, without a written approval from S-TEC Service Technologies GmbH & Co OG.  
Subject to change without notice!

## Brand - Series - Sales Name

### Maingroup - Subgroup

Salesname	Model	kW/HP	Model Year	Gearbox	Part Number	OEM Number	Info	Image
-----------	-------	-------	------------	---------	-------------	------------	------	-------

## BMW - 8 - (G15, F92) Coupe



Img.1

### Gearbox, Powertrain - Transfer Case

(G15, F92) Coupe	840 d Mild-Hybrid xDrive	250/340	2020/11-		TC00556-RI	27108465871; 27108686666		1
(G15, F92) Coupe	840 d xDrive	235/320	2018/07-2020/10		TC00556-RI	27108465871; 27108686666		1
(G15, F92) Coupe	M 850 i xDrive	390/530	2018/10-		TC00556-RI	27108465871; 27108686666		1
(G15, F92) Coupe	M8 Competition	460/625	2019/07-		TC00557-RI	27108747764		
(G15, F92) Coupe	M8	441/600	2019/07-		TC00557-RI	27108747764		

## BMW - 8 - (G16, F93) Gran Coupe



Img.1



Img.2

### Gearbox, Powertrain - Transfer Case

(G16, F93) Gran Coupe	840 d Mild-Hybrid xDrive	250/340	2020/11-		TC00556-RI	27108465871; 27108686666		1
(G16, F93) Gran Coupe	840 d xDrive	235/320	2019/07-2020/10		TC00556-RI	27108465871; 27108686666		1
(G16, F93) Gran Coupe	840 i xDrive	245/333	2020/11-		TC00555-RI	27108465870; 27108686667		2
(G16, F93) Gran Coupe	840 i xDrive	250/340	2019/07-		TC00555-RI	27108465870; 27108686667		2
(G16, F93) Gran Coupe	M 850 i xDrive	390/530	2019/07-		TC00556-RI	27108465871; 27108686666		1
(G16, F93) Gran Coupe	M8 Competition	460/625	2019/11-		TC00557-RI	27108747764		
(G16, F93) Gran Coupe	M8	441/600	2019/11-		TC00557-RI	27108747764		

All rights reserved.

This publication may not be reproduced in any form, in whole or in part, without a written approval from S-TEC Service Technologies GmbH & Co OG.  
Subject to change without notice!

### Brand - Series - Sales Name

### Maingroup - Subgroup

Salesname	Model	kW/HP	Model Year	Gearbox	Part Number	OEM Number	Info	Image
-----------	-------	-------	------------	---------	-------------	------------	------	-------

### BMW - X1 - (E84)



Img.1



Img.2



Img.3



Img.4

### Gearbox, Powertrain - Transfer Case

(E84)	xDrive 18 d	100/136	2009/03-2012/07		TC00266-RI	27105A371E5		1
(E84)	xDrive 18 d	100/136	2012/07-2015/06		TC00410-RI	27105A371E9		2
(E84)	xDrive 18 d	105/143	2009/10-2012/07		TC00266-RI	27105A371E5		1
(E84)	xDrive 18 d	105/143	2012/07-2015/06		TC00410-RI	27105A371E9		2
(E84)	xDrive 20 d	120/163	2010/03-2012/07		TC00266-RI	27105A371E5		1
(E84)	xDrive 20 d	120/163	2012/07-2015/06		TC00410-RI	27105A371E9		2
(E84)	xDrive 20 d	130/177	2009/10-2012/07		TC00266-RI	27105A371E5		1
(E84)	xDrive 20 d	130/177	2012/07-2015/06		TC00410-RI	27105A371E9		2
(E84)	xDrive 20 d	135/184	2012/07-2015/06		TC00410-RI	27105A371E9		2
(E84)	xDrive 20 i	135/184	2012/07-2015/06		TC00410-RI	27105A371E9		2
(E84)	xDrive 23 d	150/204	2009/10-2015/06		TC00266-RI	27105A371E5	Service Bulletin 002	1
(E84)	xDrive 23 d	150/204	2009/10-2015/06		TC00394-RI	27105A371E6	Service Bulletin 002	3
(E84)	xDrive 25 d	160/218	2012/07-2015/06		TC00410-RI	27105A371E9		2
(E84)	xDrive 25 i	160/218	2010/01-2015/06		TC00266-RI	27105A371E5		1
(E84)	xDrive 28 i Flex	180/245	2011/04-2012/07		TC00266-RI	27105A371E5		1
(E84)	xDrive 28 i	179/243	2011/09-2012/07		TC00266-RI	27105A371E5		1
(E84)	xDrive 28 i	179/243	2012/07-2015/06		TC00410-RI	27105A371E9		2
(E84)	xDrive 28 i	180/245	2011/04-2012/07		TC00266-RI	27105A371E5		1
(E84)	xDrive 28 i	180/245	2012/07-2015/06		TC00410-RI	27105A371E9		2
(E84)	xDrive 28 i	190/258	2009/10-2012/07		TC00266-RI	27105A371E5		1
(E84)	xDrive 28 i	190/258	2012/07-2015/06		TC00410-RI	27105A371E9		2
(E84)	xDrive 28 i	194/264	2010/03-2011/06		TC00266-RI	27105A371E5		1
(E84)	xDrive 35 i	224/305	2011/09-2012/07		TC00266-RI	27105A371E5		1
(E84)	xDrive 35 i	224/305	2012/07-2015/06		TC00413-RI	27105A371E8		4

All rights reserved.

This publication may not be reproduced in any form, in whole or in part, without a written approval from S-TEC Service Technologies GmbH & Co OG.  
Subject to change without notice!

### Brand - Series - Sales Name

### Maingroup - Subgroup

Salesname	Model	kW/HP	Model Year	Gearbox	Part Number	OEM Number	Info	Image
-----------	-------	-------	------------	---------	-------------	------------	------	-------

### BMW - X3 - (E83)



Img.1



Img.2



Img.3



Img.4

### Gearbox, Powertrain - Transfer Case

(E83)	2.0 d	110/150	2004/10-2006/06		TC00037-RI	27103455133; 27103455134; 27103455139	Service Bulletin 001	1
(E83)	2.0 d	110/150	2004/10-2010/12		TC00061-RI	27103455138	Service Bulletin 001	2
(E83)	2.0 d	110/150	2006/05-2010/12		TC00038-RI	27103455135; 27103455136; 27103455137	Service Bulletin 001	3
(E83)	2.0 i	110/150	2005/07-2008/08		TC00037-RI	27103455133; 27103455134; 27103455139		1
(E83)	2.0 sd	130/177	2007/09-2008/08		TC00256-RI	27103455131		4
(E83)	2.5 i	137/186	2004/01-2006/12		TC00037-RI	27103455133; 27103455134; 27103455139		1
(E83)	2.5 i	141/192	2004/01-2006/08		TC00037-RI	27103455133; 27103455134; 27103455139		1
(E83)	2.5 si xDrive	155/211	2006/07-2008/12		TC00038-RI	27103455135; 27103455136; 27103455137		3
(E83)	2.5 si	160/218	2006/09-2008/08		TC00038-RI	27103455135; 27103455136; 27103455137		3
(E83)	3.0 d	150/204	2004/01-2005/08		TC00037-RI	27103455133; 27103455134; 27103455139		1
(E83)	3.0 d	160/218	2004/01-2008/08		TC00037-RI	27103455133; 27103455134; 27103455139		1
(E83)	3.0 i xDrive	160/218	2006/09-2010/12		TC00038-RI	27103455135; 27103455136; 27103455137		3
(E83)	3.0 i xDrive	170/231	2004/01-2006/08		TC00037-RI	27103455133; 27103455134; 27103455139		1
(E83)	3.0 i	168/228	2004/01-2006/12		TC00037-RI	27103455133; 27103455134; 27103455139		1
(E83)	3.0 sd	210/286	2006/09-2008/08		TC00038-RI	27103455135; 27103455136; 27103455137		3
(E83)	3.0 si	194/264	2006/09-2008/08		TC00038-RI	27103455135; 27103455136; 27103455137		3
(E83)	3.0 si	200/272	2006/09-2008/08		TC00038-RI	27103455135; 27103455136; 27103455137		3
(E83)	xDrive 18 d	100/136	2009/04-2011/12		TC00256-RI	27103455131		4
(E83)	xDrive 18 d	105/143	2008/09-2011/12		TC00256-RI	27103455131		4
(E83)	xDrive 20 d	120/163	2008/09-2010/08		TC00256-RI	27103455131		4
(E83)	xDrive 20 d	130/177	2008/09-2010/08		TC00256-RI	27103455131		4
(E83)	xDrive 20 i	110/150	2008/09-2011/08		TC00037-RI	27103455133; 27103455134; 27103455139		1

All rights reserved.

This publication may not be reproduced in any form, in whole or in part, without a written approval from S-TEC Service Technologies GmbH & Co OG.  
Subject to change without notice!

### Brand - Series - Sales Name

### Maingroup - Subgroup

Salesname	Model	kW/HP	Model Year	Gearbox	Part Number	OEM Number	Info	Image
-----------	-------	-------	------------	---------	-------------	------------	------	-------

### BMW - X3 - (E83)

### Gearbox, Powertrain - Transfer Case

(E83)	xDrive 25 i	160/218	2008/09-2011/12		TC00038-RI	27103455135; 27103455136; 27103455137		3
(E83)	xDrive 30 d	155/211	2008/09-2011/04		TC00037-RI	27103455133; 27103455134; 27103455139		1
(E83)	xDrive 30 d	160/218	2008/09-2011/04		TC00037-RI	27103455133; 27103455134; 27103455139		1
(E83)	xDrive 30 i	200/272	2008/09-2011/12		TC00038-RI	27103455135; 27103455136; 27103455137		3
(E83)	xDrive 30 i	200/272	2008/09-2011/12		TC00037-RI	27103455133; 27103455134; 27103455139		1
(E83)	xDrive 35 d	210/286	2008/09-2011/08		TC00038-RI	27103455135; 27103455136; 27103455137		3

All rights reserved.

This publication may not be reproduced in any form, in whole or in part, without a written approval from S-TEC Service Technologies GmbH & Co OG.  
Subject to change without notice!

### Brand - Series - Sales Name

### Maingroup - Subgroup

Salesname	Model	kW/HP	Model Year	Gearbox	Part Number	OEM Number	Info	Image
-----------	-------	-------	------------	---------	-------------	------------	------	-------

### BMW - X3 - (F25)



Img.1



Img.2

### Gearbox, Powertrain - Transfer Case

(F25)	xDrive 20 d	120/163	2010/09-2011/10		TC00399-RI	27105A371D9		1
(F25)	xDrive 20 d	120/163	2011/10-		TC00401-RI	27105A371E2; 27105A4A0C1		2
(F25)	xDrive 20 d	135/184	2010/09-2011/10		TC00399-RI	27105A371D9		1
(F25)	xDrive 20 d	135/184	2011/10-		TC00401-RI	27105A371E2; 27105A4A0C1		2
(F25)	xDrive 20 d	140/190	2014/02-		TC00401-RI	27105A371E2; 27105A4A0C1		2
(F25)	xDrive 20 i	110/150	2013/04-		TC00401-RI	27105A371E2; 27105A4A0C1		2
(F25)	xDrive 20 i	135/184	2011/09-		TC00401-RI	27105A371E2; 27105A4A0C1		2
(F25)	xDrive 28 d	134/182	2014/09-		TC00401-RI	27105A371E2; 27105A4A0C1		2
(F25)	xDrive 28 i	179/243	2010/09-2011/10		TC00399-RI	27105A371D9		1
(F25)	xDrive 28 i	179/243	2011/10-		TC00401-RI	27105A371E2; 27105A4A0C1		2
(F25)	xDrive 28 i	180/245	2011/08-		TC00401-RI	27105A371E2; 27105A4A0C1		2
(F25)	xDrive 28 i	190/258	2011/04-2011/10		TC00399-RI	27105A371D9		1
(F25)	xDrive 28 i	190/258	2011/10-		TC00401-RI	27105A371E2; 27105A4A0C1		2
(F25)	xDrive 30 d	155/211	2011/05-2011/10		TC00399-RI	27105A371D9		1
(F25)	xDrive 30 d	155/211	2011/10-		TC00401-RI	27105A371E2; 27105A4A0C1		2
(F25)	xDrive 30 d	183/249	2015/04-		TC00401-RI	27105A371E2; 27105A4A0C1		2
(F25)	xDrive 30 d	190/258	2011/05-2011/10		TC00399-RI	27105A371D9		1
(F25)	xDrive 30 d	190/258	2011/10-		TC00401-RI	27105A371E2; 27105A4A0C1		2
(F25)	xDrive 30 d	204/277	2016/06-		TC00401-RI	27105A371E2; 27105A4A0C1		2
(F25)	xDrive 30 d	210/286	2014/04-		TC00401-RI	27105A371E2; 27105A4A0C1		2
(F25)	xDrive 35 d	230/313	2011/09-2011/10		TC00399-RI	27105A371D9		1
(F25)	xDrive 35 d	230/313	2011/10-		TC00401-RI	27105A371E2; 27105A4A0C1		2
(F25)	xDrive 35 i	225/306	2010/09-2011/10		TC00399-RI	27105A371D9		1
(F25)	xDrive 35 i	225/306	2011/10-		TC00401-RI	27105A371E2; 27105A4A0C1		2

All rights reserved.

This publication may not be reproduced in any form, in whole or in part, without a written approval from S-TEC Service Technologies GmbH & Co OG.  
Subject to change without notice!



### Brand - Series - Sales Name

### Maingroup - Subgroup

Salesname	Model	kW/HP	Model Year	Gearbox	Part Number	OEM Number	Info	Image
-----------	-------	-------	------------	---------	-------------	------------	------	-------

### BMW - X3 - (G01) Van



Img.1

### Gearbox, Powertrain - Transfer Case

(G01) Van	xDrive 20 d	140/190	2017/08-		TC00555-RI	27108465870; 27108686667		1
(G01) Van	xDrive 20 i	135/184	2017/12-		TC00555-RI	27108465870; 27108686667		1
(G01) Van	xDrive 30 d	195/265	2017/08-		TC00555-RI	27108465870; 27108686667		1
(G01) Van	xDrive 30 i	185/252	2017/08-		TC00555-RI	27108465870; 27108686667		1
(G01) Van	xDrive M40 i	265/360	2017/08-2019/08		TC00555-RI	27108465870; 27108686667		1
(G01) Van	xDrive M40 i	285/387	2019/09-		TC00555-RI	27108465870; 27108686667		1

All rights reserved.

This publication may not be reproduced in any form, in whole or in part, without a written approval from S-TEC Service Technologies GmbH & Co OG.  
Subject to change without notice!

## Brand - Series - Sales Name

### Maingroup - Subgroup

Salesname	Model	kW/HP	Model Year	Gearbox	Part Number	OEM Number	Info	Image
-----------	-------	-------	------------	---------	-------------	------------	------	-------

## BMW - X3 - (G01, F97)



Img.1

### Gearbox, Powertrain - Transfer Case

(G01, F97)	M Competition	375/510	2019/03-		TC00557-RI	27108747764		
(G01, F97)	M	353/480	2019/03-		TC00557-RI	27108747764		
(G01, F97)	xDrive 20 d	120/163	2017/08-2020/03		TC00555-RI	27108465870; 27108686667		1
(G01, F97)	xDrive 20 d	140/190	2017/08-2022/12		TC00555-RI	27108465870; 27108686667		1
(G01, F97)	xDrive 20 i	135/184	2017/12-		TC00555-RI	27108465870; 27108686667		1
(G01, F97)	xDrive 25 d	155/211	2018/04-		TC00555-RI	27108465870; 27108686667		1
(G01, F97)	xDrive 25 d	170/231	2018/04-		TC00555-RI	27108465870; 27108686667		1
(G01, F97)	xDrive 30 e Plug-in-Hybrid	120/163	2019/12-		TC00555-RI	27108465870; 27108686667		1
(G01, F97)	xDrive 30 e Plug-in-Hybrid	135/184	2019/12-		TC00555-RI	27108465870; 27108686667		1
(G01, F97)	xDrive 30 e Plug-in-Hybrid	170/231	2019/12-		TC00555-RI	27108465870; 27108686667		1
(G01, F97)	xDrive 30 e Plug-in-Hybrid	185/252	2019/12-		TC00555-RI	27108465870; 27108686667		1
(G01, F97)	xDrive 30 e Plug-in-Hybrid	200/272	2023/01-		TC00569-RI	27109847753		
(G01, F97)	xDrive 30 i	183/249	2017/08-		TC00555-RI	27108465870; 27108686667		1
(G01, F97)	xDrive 30 i	185/252	2017/08-		TC00555-RI	27108465870; 27108686667		1
(G01, F97)	xDrive 30d Mild-Hybrid	183/249	2020/07-		TC00555-RI	27108465870; 27108686667		1
(G01, F97)	xDrive 30d Mild-Hybrid	210/286	2020/07-		TC00555-RI	27108465870; 27108686667		1
(G01, F97)	xDrive 30d	195/265	2017/08-2020/06		TC00555-RI	27108465870; 27108686667		1
(G01, F97)	xDrive M40 d Mild-Hybrid	250/340	2018/08-		TC00555-RI	27108465870; 27108686667		1
(G01, F97)	xDrive M40 d	240/326	2018/08-2020/06		TC00555-RI	27108465870; 27108686667		1
(G01, F97)	xDrive M40 i	260/354	2018/09-2019/08		TC00555-RI	27108465870; 27108686667		1
(G01, F97)	xDrive M40 i	265/360	2017/08-		TC00555-RI	27108465870; 27108686667		1
(G01, F97)	xDrive M40 i	285/387	2019/09-		TC00555-RI	27108465870; 27108686667		1

All rights reserved.

This publication may not be reproduced in any form, in whole or in part, without a written approval from S-TEC Service Technologies GmbH & Co OG.  
Subject to change without notice!

## Brand - Series - Sales Name

### Maingroup - Subgroup

Salesname	Model	kW/HP	Model Year	Gearbox	Part Number	OEM Number	Info	Image
-----------	-------	-------	------------	---------	-------------	------------	------	-------

## BMW - X4 - (F26)



Img.1

### Gearbox, Powertrain - Transfer Case

(F26)	M 40 i	265/360	2015/12-		TC00401-RI	27105A371E2; 27105A4A0C1		1
(F26)	xDrive 20 d	120/163	2014/06-		TC00401-RI	27105A371E2; 27105A4A0C1		1
(F26)	xDrive 20 d	140/190	2014/04-		TC00401-RI	27105A371E2; 27105A4A0C1		1
(F26)	xDrive 20 i	135/184	2014/04-		TC00401-RI	27105A371E2; 27105A4A0C1		1
(F26)	xDrive 28 i	179/243	2014/04-2018/03		TC00401-RI	27105A371E2; 27105A4A0C1		1
(F26)	xDrive 28 i	180/245	2014/04-		TC00401-RI	27105A371E2; 27105A4A0C1		1
(F26)	xDrive 30 d	155/211	2014/04-		TC00401-RI	27105A371E2; 27105A4A0C1		1
(F26)	xDrive 30 d	183/249	2015/04-		TC00401-RI	27105A371E2; 27105A4A0C1		1
(F26)	xDrive 30 d	190/258	2014/04-		TC00401-RI	27105A371E2; 27105A4A0C1		1
(F26)	xDrive 30 d	204/277	2016/06-		TC00401-RI	27105A371E2; 27105A4A0C1		1
(F26)	xDrive 30 d	210/286	2014/04-		TC00401-RI	27105A371E2; 27105A4A0C1		1
(F26)	xDrive 35 d	230/313	2014/04-		TC00401-RI	27105A371E2; 27105A4A0C1		1
(F26)	xDrive 35 i	225/306	2014/04-		TC00401-RI	27105A371E2; 27105A4A0C1		1

## BMW - X4 - (G01, F97)



Img.1

### Gearbox, Powertrain - Transfer Case

(G01, F97)	xDrive 30d	183/249	2017/12-2020/06		TC00555-RI	27108465870; 27108686667		1
------------	------------	---------	-----------------	--	------------	-----------------------------	--	---

All rights reserved.

This publication may not be reproduced in any form, in whole or in part, without a written approval from S-TEC Service Technologies GmbH & Co OG.  
Subject to change without notice!

### Brand - Series - Sales Name

### Maingroup - Subgroup

Salesname	Model	kW/HP	Model Year	Gearbox	Part Number	OEM Number	Info	Image
-----------	-------	-------	------------	---------	-------------	------------	------	-------

### BMW - X4 - (G02, F98)



Img.1

### Gearbox, Powertrain - Transfer Case

(G02, F98)	M Competition	375/510	2019/03-		TC00557-RI	27108747764		
(G02, F98)	M40 d Mild-Hybrid xDrive	250/340	2020/07-		TC00555-RI	27108465870; 27108686667		1
(G02, F98)	M40 d xDrive	240/326	2018/04-2020/06		TC00555-RI	27108465870; 27108686667		1
(G02, F98)	M40 i xDrive	260/354	2018/04-2019/08		TC00555-RI	27108465870; 27108686667		1
(G02, F98)	M40 i xDrive	265/360	2018/04-		TC00555-RI	27108465870; 27108686667		1
(G02, F98)	M40 i xDrive	285/387	2019/09-		TC00555-RI	27108465870; 27108686667		1
(G02, F98)	M	353/480	2019/03-		TC00557-RI	27108747764		
(G02, F98)	xDrive 20 d xDrive	120/163	2018/04-2020/03		TC00555-RI	27108465870; 27108686667		1
(G02, F98)	xDrive 20 d	140/190	2018/04-2021/12		TC00555-RI	27108465870; 27108686667		1
(G02, F98)	xDrive 20 i	135/184	2018/04-		TC00555-RI	27108465870; 27108686667		1
(G02, F98)	xDrive 25 d	155/211	2018/04-		TC00555-RI	27108465870; 27108686667		1
(G02, F98)	xDrive 25 d	170/231	2018/04-		TC00555-RI	27108465870; 27108686667		1
(G02, F98)	xDrive 30 d Mild-Hybrid	183/249	2020/07-		TC00555-RI	27108465870; 27108686667		1
(G02, F98)	xDrive 30 d Mild-Hybrid	210/286	2020/07-		TC00555-RI	27108465870; 27108686667		1
(G02, F98)	xDrive 30 d	183/249	2018/09-2020/06		TC00555-RI	27108465870; 27108686667		1
(G02, F98)	xDrive 30 i	180/245	2021/10-		TC00569-RI	27109847753		
(G02, F98)	xDrive 30 i	183/249	2018/04-		TC00555-RI	27108465870; 27108686667		1
(G02, F98)	xDrive 30 i	185/252	2018/04-		TC00555-RI	27108465870; 27108686667		1

### BMW - X4 - (G05, F98)



Img.1

### Gearbox, Powertrain - Transfer Case

(G05, F98)	xDrive 20 d Mild-Hybrid	120/163	2020/04-		TC00555-RI	27108465870; 27108686667		1
(G05, F98)	xDrive 20 d Mild-Hybrid	140/190	2020/04-		TC00555-RI	27108465870; 27108686667		1

All rights reserved.

This publication may not be reproduced in any form, in whole or in part, without a written approval from S-TEC Service Technologies GmbH & Co OG.  
Subject to change without notice!

## Brand - Series - Sales Name

### Maingroup - Subgroup

Salesname	Model	kW/HP	Model Year	Gearbox	Part Number	OEM Number	Info	Image
-----------	-------	-------	------------	---------	-------------	------------	------	-------

## BMW - X5 - (E53)



Img.1

### Gearbox, Powertrain - Transfer Case

(E53)	3.0 d	155/211	2003/09-2006/12		TC00039-RI	27107555295; 27107555297		1
(E53)	3.0 d	160/218	2003/12-2006/12		TC00039-RI	27107555295; 27107555297		1
(E53)	3.0 i	163/222	2003/10-2006/12		TC00039-RI	27107555295; 27107555297		1
(E53)	3.0 i	170/231	2003/10-2006/12		TC00039-RI	27107555295; 27107555297		1
(E53)	3.0	168/228	2003/10-2006/12		TC00039-RI	27107555295; 27107555297		1
(E53)	4.4 i	235/320	2003/12-2006/09		TC00039-RI	27107555295; 27107555297		1
(E53)	4.8 is	265/360	2004/04-2006/09		TC00039-RI	27107555295; 27107555297		1

All rights reserved.

This publication may not be reproduced in any form, in whole or in part, without a written approval from S-TEC Service Technologies GmbH & Co OG.  
Subject to change without notice!

### Brand - Series - Sales Name

### Maingroup - Subgroup

Salesname	Model	kW/HP	Model Year	Gearbox	Part Number	OEM Number	Info	Image
-----------	-------	-------	------------	---------	-------------	------------	------	-------

### BMW - X5 - (E70)



Img.1



Img.2



Img.3



Img.4



Img.5

### Gearbox, Powertrain - Transfer Case

(E70)	3.0 d	135/184	2007/02-2013/06		TC00200-RI	27107599886; 27107599889	Transfer Case Change: Cars till MY 06/2009 also require the change of the Vent Pipe. Vent Pipe BMW OE code 27107595633.	1
(E70)	3.0 d	155/211	2007/02-2008/09		TC00200-RI	27107599886; 27107599889	Transfer Case Change: Cars till MY 06/2009 also require the change of the Vent Pipe. Vent Pipe BMW OE code 27107595633.	1
(E70)	3.0 d	173/235	2007/02-2008/09		TC00200-RI	27107599886; 27107599889	Transfer Case Change: Cars till MY 06/2009 also require the change of the Vent Pipe. Vent Pipe BMW OE code 27107595633.	1
(E70)	3.0 sd	210/286	2007/09-2009/02		TC00200-RI	27107599886; 27107599889	Transfer Case Change: Cars till MY 06/2009 also require the change of the Vent Pipe. Vent Pipe BMW OE code 27107595633.	1
(E70)	3.0 si	171/230	2007/02-2008/09		TC00200-RI	27107599886; 27107599889	Transfer Case Change: Cars till MY 06/2009 also require the change of the Vent Pipe. Vent Pipe BMW OE code 27107595633.	1
(E70)	3.0 si	200/272	2007/02-2008/09		TC00200-RI	27107599886; 27107599889	Transfer Case Change: Cars till MY 06/2009 also require the change of the Vent Pipe. Vent Pipe BMW OE code 27107595633.	1
(E70)	4.8 i xDrive	261/355	2007/02-2008/09		TC00200-RI	27107599886; 27107599889	Transfer Case Change: Cars till MY 06/2009 also require the change of the Vent Pipe. Vent Pipe BMW OE code 27107595633.	1
(E70)	M 50 d	280/381	2012/04-2013/06		TC00396-RI	27105A371E1; 27105A4A0C0		2
(E70)	M	408/555	2009/09-2013/06		TC00261-RI	27107599887; 27107599890		3
(E70)	xDrive 30 d	155/211	2008/09-2012/04		TC00398-RI	27105A371D7		4
(E70)	xDrive 30 d	155/211	2012/04-2013/06		TC00396-RI	27105A371E1; 27105A4A0C0		2
(E70)	xDrive 30 d	173/235	2008/09-2012/04		TC00398-RI	27105A371D7		4
(E70)	xDrive 30 d	173/235	2012/04-2013/06		TC00396-RI	27105A371E1; 27105A4A0C0		2
(E70)	xDrive 30 d	180/245	2010/09-2012/04		TC00398-RI	27105A371D7		4
(E70)	xDrive 30 d	180/245	2012/04-2013/06		TC00396-RI	27105A371E1; 27105A4A0C0		2

All rights reserved.

This publication may not be reproduced in any form, in whole or in part, without a written approval from S-TEC Service Technologies GmbH & Co OG.  
Subject to change without notice!

### Brand - Series - Sales Name

### Maingroup - Subgroup

Salesname	Model	kW/HP	Model Year	Gearbox	Part Number	OEM Number	Info	Image
-----------	-------	-------	------------	---------	-------------	------------	------	-------

### BMW - X5 - (E70)

### Gearbox, Powertrain - Transfer Case

(E70)	xDrive 30 i	171/230	2008/09-2010/12		TC00200-RI	27107599886; 27107599889	Transfer Case Change: Cars till MY 06/2009 also require the change of the Vent Pipe. Vent Pipe BMW OE code 27107595633.	1
(E70)	xDrive 30 i	172/234	2007/02-2012/12		TC00200-RI	27107599886; 27107599889	Transfer Case Change: Cars till MY 06/2009 also require the change of the Vent Pipe. Vent Pipe BMW OE code 27107595633.	1
(E70)	xDrive 30 i	200/272	2008/09-2010/03		TC00200-RI	27107599886; 27107599889	Transfer Case Change: Cars till MY 06/2009 also require the change of the Vent Pipe. Vent Pipe BMW OE code 27107595633.	1
(E70)	xDrive 35 d	198/269	2008/09-2012/12		TC00200-RI	27107599886; 27107599889	Transfer Case Change: Cars till MY 06/2009 also require the change of the Vent Pipe. Vent Pipe BMW OE code 27107595633.	1
(E70)	xDrive 35 d	210/286	2008/09-2013/06		TC00200-RI	27107599886; 27107599889	Transfer Case Change: Cars till MY 06/2009 also require the change of the Vent Pipe. Vent Pipe BMW OE code 27107595633.	1
(E70)	xDrive 35 i	225/306	2010/09-2012/04		TC00398-RI	27105A371D7		4
(E70)	xDrive 35 i	225/306	2012/04-2013/06		TC00396-RI	27105A371E1; 27105A4A0C0		2
(E70)	xDrive 35 i	235/320	2012/02-2012/04		TC00398-RI	27105A371D7		4
(E70)	xDrive 35 i	235/320	2012/04-2013/06		TC00396-RI	27105A371E1; 27105A4A0C0		2
(E70)	xDrive 40 d	225/306	2010/09-2012/04		TC00398-RI	27105A371D7		4
(E70)	xDrive 40 d	225/306	2012/04-2013/06		TC00396-RI	27105A371E1; 27105A4A0C0		2
(E70)	xDrive 40 i	225/306	2012/01-2013/06		TC00396-RI	27105A371E1; 27105A4A0C0		2
(E70)	xDrive 48 i	261/355	2008/09-2013/06		TC00200-RI	27107599886; 27107599889	Transfer Case Change: Cars till MY 06/2009 also require the change of the Vent Pipe. Vent Pipe BMW OE code 27107595633.	1
(E70)	xDrive 50 i	298/405	2009/09-2012/04		TC00400-RI	27105A371D8		5
(E70)	xDrive 50 i	298/405	2012/04-2013/06		TC00397-RI	27105A371E0; 27105A4A0B9		
(E70)	xDrive 50 i	300/408	2010/06-2012/04		TC00400-RI	27105A371D8		5
(E70)	xDrive 50 i	300/408	2012/04-2013/06		TC00397-RI	27105A371E0; 27105A4A0B9		

All rights reserved.

This publication may not be reproduced in any form, in whole or in part, without a written approval from S-TEC Service Technologies GmbH & Co OG.  
Subject to change without notice!

### Brand - Series - Sales Name

### Maingroup - Subgroup

Salesname	Model	kW/HP	Model Year	Gearbox	Part Number	OEM Number	Info	Image
-----------	-------	-------	------------	---------	-------------	------------	------	-------

### BMW - X5 - (F15, F85)



Img.1

### Gearbox, Powertrain - Transfer Case

(F15, F85)	M 50 d	280/381	2013/07-		TC00401-RI	27105A371E2; 27105A4A0C1		1
(F15, F85)	M	423/575	2014/12-		TC00416-RI	27105A371E4; 27105A4A0C3		
(F15, F85)	xDrive 25 d	155/211	2013/11-		TC00401-RI	27105A371E2; 27105A4A0C1		1
(F15, F85)	xDrive 25 d	160/218	2013/11-		TC00401-RI	27105A371E2; 27105A4A0C1		1
(F15, F85)	xDrive 25 d	170/231	2015/07-		TC00401-RI	27105A371E2; 27105A4A0C1		1
(F15, F85)	xDrive 28 i	180/245	2015/09-		TC00401-RI	27105A371E2; 27105A4A0C1		1
(F15, F85)	xDrive 30 d	183/249	2015/04-		TC00401-RI	27105A371E2; 27105A4A0C1		1
(F15, F85)	xDrive 30 d	190/258	2013/07-		TC00401-RI	27105A371E2; 27105A4A0C1		1
(F15, F85)	xDrive 30 d	204/277	2013/11-		TC00401-RI	27105A371E2; 27105A4A0C1		1
(F15, F85)	xDrive 35 i	225/306	2013/11-		TC00401-RI	27105A371E2; 27105A4A0C1		1
(F15, F85)	xDrive 35 i	240/326	2013/11-		TC00401-RI	27105A371E2; 27105A4A0C1		1
(F15, F85)	xDrive 40 d	230/313	2013/12-		TC00401-RI	27105A371E2; 27105A4A0C1		1
(F15, F85)	xDrive 40e	155/211	2015/09-		TC00401-RI	27105A371E2; 27105A4A0C1		1
(F15, F85)	xDrive 40e	180/245	2015/09-		TC00401-RI	27105A371E2; 27105A4A0C1		1
(F15, F85)	xDrive 40e	205/279	2015/09-		TC00401-RI	27105A371E2; 27105A4A0C1		1
(F15, F85)	xDrive 40e	230/313	2015/09-		TC00401-RI	27105A371E2; 27105A4A0C1		1
(F15, F85)	xDrive 50 i	300/408	2014/02-		TC00403-RI	27105A371E3; 27105A4A0C2		
(F15, F85)	xDrive 50 i	330/449	2013/07-		TC00403-RI	27105A371E3; 27105A4A0C2		
(F15, F85)	xDrive 50 i	332/452	2013/07-		TC00403-RI	27105A371E3; 27105A4A0C2		

### BMW - X5 - (G02, F98)



Img.1

### Gearbox, Powertrain - Transfer Case

(G02, F98)	xDrive 30 d	195/265	2018/04-2020/06		TC00555-RI	27108465870; 27108686667		1
------------	-------------	---------	-----------------	--	------------	-----------------------------	--	---

All rights reserved.

This publication may not be reproduced in any form, in whole or in part, without a written approval from S-TEC Service Technologies GmbH & Co OG.  
Subject to change without notice!



### Brand - Series - Sales Name

### Maingroup - Subgroup

Salesname	Model	kW/HP	Model Year	Gearbox	Part Number	OEM Number	Info	Image
-----------	-------	-------	------------	---------	-------------	------------	------	-------

### BMW - X5 - (G05) Van



Img.1

### Gearbox, Powertrain - Transfer Case

(G05) Van	xDrive 40 i	250/340	2019/11-		TC00555-RI	27108465870; 27108686667		1
-----------	-------------	---------	----------	--	------------	-----------------------------	--	---

### BMW - X5 - (G05, F95)



Img.1

### Gearbox, Powertrain - Transfer Case

(G05, F95)	sDrive 40 i	250/340	2019/08-		TC00555-RI	27108465870; 27108686667		1
------------	-------------	---------	----------	--	------------	-----------------------------	--	---

All rights reserved.

This publication may not be reproduced in any form, in whole or in part, without a written approval from S-TEC Service Technologies GmbH & Co OG.  
Subject to change without notice!

## Brand - Series - Sales Name

### Maingroup - Subgroup

Salesname	Model	kW/HP	Model Year	Gearbox	Part Number	OEM Number	Info	Image
-----------	-------	-------	------------	---------	-------------	------------	------	-------

## BMW - X5 - (G05, F95)



Img.1



Img.2

### Gearbox, Powertrain - Transfer Case

(G05, F95)	sDrive 40 i	250/340	2019/08-		TC00556-RI	27108465871; 27108686666		1
(G05, F95)	xDrive 25 d	155/211	2019/08-		TC00555-RI	27108465870; 27108686667		2
(G05, F95)	xDrive 25 d	170/231	2019/08-		TC00555-RI	27108465870; 27108686667		2
(G05, F95)	xDrive 30 d Mild-Hybrid	183/249	2020/08-		TC00556-RI	27108465871; 27108686666		1
(G05, F95)	xDrive 30 d Mild-Hybrid	210/286	2020/08-		TC00556-RI	27108465871; 27108686666		1
(G05, F95)	xDrive 30 d	183/249	2018/08-2020/07		TC00556-RI	27108465871; 27108686666		1
(G05, F95)	xDrive 30 d	195/265	2018/08-2020/07		TC00556-RI	27108465871; 27108686666		1
(G05, F95)	xDrive 30 i	195/265	2019/09-		TC00555-RI	27108465870; 27108686667		2
(G05, F95)	xDrive 40 d Mild-Hybrid	250/340	2020/05-		TC00556-RI	27108465871; 27108686666		1
(G05, F95)	xDrive 40 i Mild-Hybrid	245/333	2020/12-		TC00556-RI	27108465871; 27108686666		1
(G05, F95)	xDrive 40 i Mild-Hybrid	245/333	2020/12-		TC00555-RI	27108465870; 27108686667		2
(G05, F95)	xDrive 40 i	250/340	2018/08-		TC00556-RI	27108465871; 27108686666		1
(G05, F95)	xDrive 40 i	250/340	2018/08-		TC00555-RI	27108465870; 27108686667		2
(G05, F95)	xDrive 45 e Plug-in-Hybrid	155/211	2019/06-		TC00556-RI	27108465871; 27108686666		1
(G05, F95)	xDrive 45 e Plug-in-Hybrid	210/286	2019/06-		TC00556-RI	27108465871; 27108686666		1
(G05, F95)	xDrive 45 e Plug-in-Hybrid	235/320	2019/06-		TC00556-RI	27108465871; 27108686666		1
(G05, F95)	xDrive 45 e Plug-in-Hybrid	290/394	2019/06-		TC00556-RI	27108465871; 27108686666		1
(G05, F95)	xDrive 50 i	340/462	2018/08-		TC00556-RI	27108465871; 27108686666		1
(G05, F95)	xDrive M 50 d	294/400	2018/08-		TC00556-RI	27108465871; 27108686666		1

## BMW - X5 - (G06, F96)



Img.1

### Gearbox, Powertrain - Transfer Case

(G06, F96)	M50 i xDrive	390/530	2019/08-		TC00556-RI	27108465871; 27108686666		1
------------	--------------	---------	----------	--	------------	-----------------------------	--	---

All rights reserved.

This publication may not be reproduced in any form, in whole or in part, without a written approval from S-TEC Service Technologies GmbH & Co OG.  
Subject to change without notice!

### Brand - Series - Sales Name

### Maingroup - Subgroup

Salesname	Model	kW/HP	Model Year	Gearbox	Part Number	OEM Number	Info	Image
-----------	-------	-------	------------	---------	-------------	------------	------	-------

### BMW - X6 - (E71, E72)



Img.1



Img.2



Img.3



Img.4



Img.5



Img.6

### Gearbox, Powertrain - Transfer Case

(E71, E72)	30 d	173/235	2008/05-2008/08		TC00200-RI	27107599886; 27107599889	Transfer Case Change: Cars till MY 06/2009 also require the change of the Vent Pipe. Vent Pipe BMW OE code 27107595633.	1
(E71, E72)	35 d	210/286	2008/05-2008/08		TC00200-RI	27107599886; 27107599889	Transfer Case Change: Cars till MY 06/2009 also require the change of the Vent Pipe. Vent Pipe BMW OE code 27107595633.	1
(E71, E72)	35 i	225/306	2008/05-2008/08		TC00200-RI	27107599886; 27107599889	Transfer Case Change: Cars till MY 06/2009 also require the change of the Vent Pipe. Vent Pipe BMW OE code 27107595633.	1
(E71, E72)	50 i	300/408	2008/05-2009/06		TC00261-RI	27107599887; 27107599890		2
(E71, E72)	50 i	300/408	2009/06-2012/04		TC00400-RI	27105A371D8		3
(E71, E72)	50 i	300/408	2012/04-2014/06		TC00397-RI	27105A371E0; 27105A4A0B9		
(E71, E72)	ActiveHybrid	300/408	2009/01-2011/10		TC00260-RI	27107599898; 27107599899		4
(E71, E72)	ActiveHybrid	357/485	2009/01-2011/10		TC00260-RI	27107599898; 27107599899		4
(E71, E72)	M 50 d	280/381	2011/08-2014/06		TC00396-RI	27105A371E1; 27105A4A0C0		5
(E71, E72)	M	408/555	2008/07-2014/06		TC00261-RI	27107599887; 27107599890		2
(E71, E72)	M	414/563	2008/07-2014/06		TC00261-RI	27107599887; 27107599890		2
(E71, E72)	M	423/575	2009/07-2014/06		TC00261-RI	27107599887; 27107599890		2
(E71, E72)	xDrive 30 d	155/211	2009/07-2012/04		TC00398-RI	27105A371D7		6
(E71, E72)	xDrive 30 d	155/211	2012/04-2014/06		TC00396-RI	27105A371E1; 27105A4A0C0		5
(E71, E72)	xDrive 30 d	173/235	2007/09-2010/03		TC00398-RI	27105A371D7		6
(E71, E72)	xDrive 30 d	180/245	2009/04-2012/04		TC00398-RI	27105A371D7		6
(E71, E72)	xDrive 30 d	180/245	2012/04-2014/06		TC00396-RI	27105A371E1; 27105A4A0C0		5
(E71, E72)	xDrive 35 d	210/286	2007/06-2010/03		TC00261-RI	27107599887; 27107599890		2
(E71, E72)	xDrive 35 i	224/305	2008/01-2014/06		TC00200-RI	27107599886; 27107599889	Transfer Case Change: Cars till MY 06/2009 also require the change of the Vent Pipe. Vent Pipe BMW OE code 27107595633.	1
(E71, E72)	xDrive 35 i	224/305	2008/01-2014/06		TC00398-RI	27105A371D7		6
(E71, E72)	xDrive 35 i	225/306	2007/06-2010/03		TC00398-RI	27105A371D7		6
(E71, E72)	xDrive 35 i	235/320	2009/07-2012/04		TC00398-RI	27105A371D7		6
(E71, E72)	xDrive 35 i	235/320	2012/04-2014/06		TC00396-RI	27105A371E1; 27105A4A0C0		5

All rights reserved.

This publication may not be reproduced in any form, in whole or in part, without a written approval from S-TEC Service Technologies GmbH & Co OG.  
Subject to change without notice!

### Brand - Series - Sales Name

### Maingroup - Subgroup

Salesname	Model	kW/HP	Model Year	Gearbox	Part Number	OEM Number	Info	Image
-----------	-------	-------	------------	---------	-------------	------------	------	-------

### BMW - X6 - (E71, E72)

### Gearbox, Powertrain - Transfer Case

(E71, E72)	xDrive 35 i	240/326	2007/06-2010/03		TC00261-RI	27107599887; 27107599890		2
(E71, E72)	xDrive 40 d	225/306	2009/07-2012/04		TC00398-RI	27105A371D7		6
(E71, E72)	xDrive 40 d	225/306	2012/04-2014/06		TC00396-RI	27105A371E1; 27105A4A0C0		5
(E71, E72)	xDrive 50 i	298/405	2007/10-2009/06		TC00261-RI	27107599887; 27107599890	Transfer Case Change: Cars till MY 06/2009 also require the change of the Vent Pipe. Vent Pipe BMW OE code 27107595633.	2
(E71, E72)	xDrive 50 i	298/405	2009/06-2012/04		TC00400-RI	27105A371D8		3
(E71, E72)	xDrive 50 i	298/405	2012/04-2014/06		TC00397-RI	27105A371E0; 27105A4A0B9		
(E71, E72)	xDrive 50 i	300/408	2007/10-2009/06		TC00261-RI	27107599887; 27107599890	Transfer Case Change: Cars till MY 06/2009 also require the change of the Vent Pipe. Vent Pipe BMW OE code 27107595633.	2
(E71, E72)	xDrive 50 i	300/408	2009/06-2012/04		TC00400-RI	27105A371D8		3
(E71, E72)	xDrive 50 i	300/408	2012/04-2014/06		TC00397-RI	27105A371E0; 27105A4A0B9		
(E71, E72)	xDrive 50 i	330/449	2007/10-2009/06		TC00261-RI	27107599887; 27107599890	Transfer Case Change: Cars till MY 06/2009 also require the change of the Vent Pipe. Vent Pipe BMW OE code 27107595633.	2
(E71, E72)	xDrive 50 i	330/449	2009/06-2012/04		TC00400-RI	27105A371D8		3
(E71, E72)	xDrive 50 i	330/449	2012/04-2014/06		TC00397-RI	27105A371E0; 27105A4A0B9		

All rights reserved.

This publication may not be reproduced in any form, in whole or in part, without a written approval from S-TEC Service Technologies GmbH & Co OG.  
Subject to change without notice!

### Brand - Series - Sales Name

### Maingroup - Subgroup

Salesname	Model	kW/HP	Model Year	Gearbox	Part Number	OEM Number	Info	Image
-----------	-------	-------	------------	---------	-------------	------------	------	-------

### BMW - X6 - (F16, F86)



Img.1

### Gearbox, Powertrain - Transfer Case

(F16, F86)	M 50 d	280/381	2014/08-		TC00401-RI	27105A371E2; 27105A4A0C1		1
(F16, F86)	M	423/575	2014/12-		TC00416-RI	27105A371E4; 27105A4A0C3		
(F16, F86)	xDrive 28 i	180/245	2015/09-		TC00401-RI	27105A371E2; 27105A4A0C1		1
(F16, F86)	xDrive 30 d	155/211	2014/08-		TC00401-RI	27105A371E2; 27105A4A0C1		1
(F16, F86)	xDrive 30 d	160/218	2016/09-		TC00401-RI	27105A371E2; 27105A4A0C1		1
(F16, F86)	xDrive 30 d	183/249	2015/12-		TC00401-RI	27105A371E2; 27105A4A0C1		1
(F16, F86)	xDrive 30 d	190/258	2014/08-		TC00401-RI	27105A371E2; 27105A4A0C1		1
(F16, F86)	xDrive 30 d	204/277	2015/02-		TC00401-RI	27105A371E2; 27105A4A0C1		1
(F16, F86)	xDrive 35 i	225/306	2014/12-		TC00401-RI	27105A371E2; 27105A4A0C1		1
(F16, F86)	xDrive 35 i	240/326	2015/02-		TC00401-RI	27105A371E2; 27105A4A0C1		1
(F16, F86)	xDrive 40 d	230/313	2014/12-		TC00401-RI	27105A371E2; 27105A4A0C1		1
(F16, F86)	xDrive 50 i	300/408	2014/11-		TC00403-RI	27105A371E3; 27105A4A0C2		
(F16, F86)	xDrive 50 i	330/449	2014/08-		TC00403-RI	27105A371E3; 27105A4A0C2		

### BMW - X6 - (G05, F95)



Img.1

### Gearbox, Powertrain - Transfer Case

(G05, F95)	xDrive 30 d Mild-Hybrid	155/211	2020/08-		TC00556-RI	27108465871; 27108686666		1
(G05, F95)	xDrive 30 d Mild-Hybrid	183/249	2020/08-		TC00556-RI	27108465871; 27108686666		1
(G05, F95)	xDrive 30 d Mild-Hybrid	210/286	2020/08-		TC00556-RI	27108465871; 27108686666		1

All rights reserved.

This publication may not be reproduced in any form, in whole or in part, without a written approval from S-TEC Service Technologies GmbH & Co OG.  
Subject to change without notice!

### Brand - Series - Sales Name

### Maingroup - Subgroup

Salesname	Model	kW/HP	Model Year	Gearbox	Part Number	OEM Number	Info	Image
-----------	-------	-------	------------	---------	-------------	------------	------	-------

### BMW - X6 - (G06, F96)



Img.1



Img.2

### Gearbox, Powertrain - Transfer Case

(G06, F96)	M50 i xDrive	390/530	2019/08-		TC00556-RI	27108465871; 27108686666		1
(G06, F96)	xDrive 30 d	155/211	2019/08-2020/07		TC00556-RI	27108465871; 27108686666		1
(G06, F96)	xDrive 30 d	183/249	2019/08-2020/07		TC00556-RI	27108465871; 27108686666		1
(G06, F96)	xDrive 30 d	195/265	2019/08-2020/07		TC00556-RI	27108465871; 27108686666		1
(G06, F96)	xDrive 30 i	195/265	2019/11-		TC00555-RI	27108465870; 27108686667		2
(G06, F96)	xDrive 40 i Mild-Hybrid	245/333	2020/12-		TC00555-RI	27108465870; 27108686667		2
(G06, F96)	xDrive 40 i	250/340	2019/08-		TC00555-RI	27108465870; 27108686667		2
(G06, F96)	xDrive M 50 d	294/400	2019/08-		TC00556-RI	27108465871; 27108686666		1

### BMW - X7 - (G07)



Img.1



Img.2

### Gearbox, Powertrain - Transfer Case

(G07)	xDrive 30 d	155/211	2019/03-2020/08		TC00556-RI	27108465871; 27108686666		1
(G07)	xDrive 30 d	183/249	2019/03-		TC00556-RI	27108465871; 27108686666		1
(G07)	xDrive 30 d	195/265	2019/03-		TC00556-RI	27108465871; 27108686666		1
(G07)	xDrive 40 d Mild-Hybrid	155/211	2019/03-		TC00556-RI	27108465871; 27108686666		1
(G07)	xDrive 40 d Mild-Hybrid	250/340	2019/03-		TC00556-RI	27108465871; 27108686666		1
(G07)	xDrive 40 i Mild-Hybrid	245/333	2020/12-		TC00555-RI	27108465870; 27108686667		2
(G07)	xDrive 40 i	250/340	2019/03-		TC00555-RI	27108465870; 27108686667		2
(G07)	xDrive 50 i	340/462	2019/03-		TC00556-RI	27108465871; 27108686666		1
(G07)	xDrive M 50 i	390/530	2019/04-		TC00556-RI	27108465871; 27108686666		1

All rights reserved.

This publication may not be reproduced in any form, in whole or in part, without a written approval from S-TEC Service Technologies GmbH & Co OG.  
Subject to change without notice!

### Brand - Series - Sales Name

### Maingroup - Subgroup

Salesname	Model	kW/HP	Model Year	Gearbox	Part Number	OEM Number	Info	Image
-----------	-------	-------	------------	---------	-------------	------------	------	-------

### Chrysler - 300 - 300C



Img.1

### Front Axle, Steering Unit - Power take off (PTO)

300C	3.6 AWD	210/286	2012/12-		FD00061-RI	68495080AA		1
300C	3.6 AWD	215/292	2012/01-		FD00061-RI	68495080AA		1
300C	3.6 AWD	218/296	2011/09-		FD00061-RI	68495080AA		1
300C	3.6 AWD	224/305	2014/09-		FD00061-RI	68495080AA		1
300C	3.6 Flexfuel AWD	218/296	2011/09-		FD00061-RI	68495080AA		1
300C	3.6 Flexfuel AWD	224/305	2014/09-		FD00061-RI	68495080AA		1
300C	5.7 AWD	271/369	2010/09-		FD00061-RI	68495080AA		1
300C	5.7 Flexfuel AWD	271/369	2010/09-2012/12		FD00061-RI	68495080AA		1

### Chrysler - 300 - 300C (LX)



Img.1

### Front Axle, Steering Unit - Power take off (PTO)

300C (LX)	3.5 AWD	183/249	2004/09-2010/12		FD00045-RI	04591954AB		1
300C (LX)	3.5 AWD	186/253	2004/09-2010/12		FD00045-RI	04591954AB		1
300C (LX)	5.7 AWD	250/340	2004/09-2010/12		FD00045-RI	04591954AB		1
300C (LX)	5.7 AWD	254/345	2004/09-2007/12		FD00045-RI	04591954AB		1
300C (LX)	5.7 AWD	269/366	2008/09-		FD00045-RI	04591954AB		1



Img.1

### Gearbox, Powertrain - Transfer Case

300C (LX)	3.5 AWD	183/249	2004/09-2010/12		TC00008-RI	04591953AI		1
300C (LX)	3.5 AWD	186/253	2004/09-2010/12		TC00008-RI	04591953AI		1
300C (LX)	5.7 AWD	250/340	2004/09-2010/12		TC00008-RI	04591953AI		1
300C (LX)	5.7 AWD	254/345	2004/09-2007/12		TC00008-RI	04591953AI		1
300C (LX)	5.7 AWD	269/366	2008/09-		TC00008-RI	04591953AI		1

All rights reserved.

This publication may not be reproduced in any form, in whole or in part, without a written approval from S-TEC Service Technologies GmbH & Co OG.  
Subject to change without notice!

## Brand - Series - Sales Name

### Maingroup - Subgroup

Salesname	Model	kW/HP	Model Year	Gearbox	Part Number	OEM Number	Info	Image
-----------	-------	-------	------------	---------	-------------	------------	------	-------

## Dodge - Charger - CHARGER



Img.1



Img.2

### Front Axle, Steering Unit - Power take off (PTO)

CHARGER	2.7	133/181	2008/09-2010/12		FD00045-RI	04591954AB		1
CHARGER	3.5	186/253	2006/09-2010/12		FD00045-RI	04591954AB		1
CHARGER	3.6	218/296	2011/01-2014/12		FD00061-RI	68495080AA		2
CHARGER	3.6	227/309	2017/09-		FD00061-RI	68495080AA		2
CHARGER	3.6	218/296	2011/09-		FD00061-RI	68495080AA		2
CHARGER	5.7 R/T	276/375	2008/09-2010/12		FD00045-RI	04591954AB		1
CHARGER	5.7 R/T	276/375	2011/09-		FD00061-RI	68495080AA		2
CHARGER	5.7	254/345	2006/09-2008/12		FD00045-RI	04591954AB		1
CHARGER	5.7	276/375	2011/11-		FD00061-RI	68495080AA		2



Img.1

### Gearbox, Powertrain - Transfer Case

CHARGER	3.5	186/253	2006/09-2010/12		TC00008-RI	04591953AI		1
CHARGER	5.7 R/T	276/375	2008/09-2010/12		TC00008-RI	04591953AI		1
CHARGER	5.7	254/345	2006/09-2008/12		TC00008-RI	04591953AI		1

## Dodge - Magnum - MAGNUM



Img.1

### Front Axle, Steering Unit - Power take off (PTO)

MAGNUM	2.7	142/193	2006/09-2007/12		FD00045-RI	04591954AB		1
MAGNUM	3.5	187/254	2004/09-2008/12		FD00045-RI	04591954AB		1
MAGNUM	5.7 R/T	254/345	2004/09-2008/12		FD00045-RI	04591954AB		1



Img.1

### Gearbox, Powertrain - Transfer Case

MAGNUM	3.5	187/254	2004/09-2008/12		TC00008-RI	04591953AI		1
MAGNUM	5.7 R/T	254/345	2004/09-2008/12		TC00008-RI	04591953AI		1

All rights reserved.

This publication may not be reproduced in any form, in whole or in part, without a written approval from S-TEC Service Technologies GmbH & Co OG.  
Subject to change without notice!



### Brand - Series - Sales Name

### Maingroup - Subgroup

Salesname	Model	kW/HP	Model Year	Gearbox	Part Number	OEM Number	Info	Image
-----------	-------	-------	------------	---------	-------------	------------	------	-------

### Fiat - Panda - PANDA (312\_, 319\_)



Img.1

#### Rear Axle - Rear Differential

PANDA (312_, 319_)	0.9 4x4	63/86	2012/09-		RD00095-RI	55263470		1
PANDA (312_, 319_)	0.9 4x4	66/90	2014/06-		RD00095-RI	55263470		1
PANDA (312_, 319_)	1.3 D Multijet 4x4	55/75	2012/06-		RD00095-RI	55263470		1
PANDA (312_, 319_)	1.3 D Multijet 4x4	59/80	2014/06-		RD00095-RI	55263470		1
PANDA (312_, 319_)	1.3 D Multijet 4x4	70/95	2015/04-		RD00095-RI	55263470		1

### Fiat - Panda - PANDA Van (312\_, 519\_)



Img.1

#### Rear Axle - Rear Differential

PANDA Van (312_, 519_)	0.9 4x4	63/86	2012/09-		RD00095-RI	55263470		1
PANDA Van (312_, 519_)	1.3 D Multijet 4x4	55/75	2012/06-		RD00095-RI	55263470		1
PANDA Van (312_, 519_)	1.3 D Multijet 4x4	59/80	2014/06-		RD00095-RI	55263470		1

All rights reserved.

This publication may not be reproduced in any form, in whole or in part, without a written approval from S-TEC Service Technologies GmbH & Co OG.  
Subject to change without notice!

### Brand - Series - Sales Name

### Maingroup - Subgroup

Salesname	Model	kW/HP	Model Year	Gearbox	Part Number	OEM Number	Info	Image
-----------	-------	-------	------------	---------	-------------	------------	------	-------

### Hyundai - Genesis - GENESIS (DH)

### Gearbox, Powertrain - Transfer Case

GENESIS (DH)	3.0 GDI 4WD	183/249	2014/06-		TC00512-RI	473004E000		
GENESIS (DH)	3.0 GDI 4WD	189/257	2014/08-		TC00512-RI	473004E000		
GENESIS (DH)	3.3 GDI 4WD	207/282	2014/08-		TC00512-RI	473004E000		
GENESIS (DH)	3.8 GDI 4WD	232/315	2014/06-		TC00512-RI	473004E000		

All rights reserved.

This publication may not be reproduced in any form, in whole or in part, without a written approval from S-TEC Service Technologies GmbH & Co OG.  
Subject to change without notice!

### Brand - Series - Sales Name

### Maingroup - Subgroup

Salesname	Model	kW/HP	Model Year	Gearbox	Part Number	OEM Number	Info	Image
-----------	-------	-------	------------	---------	-------------	------------	------	-------

### Infiniti - QX56 - QX56



Img.1

### Gearbox, Powertrain - Transfer Case

QX56	5.6 AWD	294/400	2012/01-	7AT	TC00271-RI	331001LA0E		1
QX56	5.6 AWD	298/405	2010/03-	7AT	TC00271-RI	331001LA0E		1

### Infiniti - QX80 - QX80



Img.1

### Gearbox, Powertrain - Transfer Case

QX80	5.6 AWD	294/400	2013/09-	7AT	TC00271-RI	331001LA0E		1
QX80	5.6 AWD	298/405	2013/09-	7AT	TC00271-RI	331001LA0E		1
QX80	5.6 D AWD	324/441	2013/09-	7AT	TC00271-RI	331001LA0E		1

All rights reserved.

This publication may not be reproduced in any form, in whole or in part, without a written approval from S-TEC Service Technologies GmbH & Co OG.  
Subject to change without notice!

## Brand - Series - Sales Name

### Maingroup - Subgroup

Salesname	Model	kW/HP	Model Year	Gearbox	Part Number	OEM Number	Info	Image
-----------	-------	-------	------------	---------	-------------	------------	------	-------

## Jaguar - F-Type - F-TYPE Cabriolet (X152)



Img.1

### Gearbox, Powertrain - Transfer Case

F-TYPE Cabriolet (X152)	3.0 S	280/380	2014/12-		TC00511-RI	FW937K780AF		1
F-TYPE Cabriolet (X152)	3.0	250/340	2017/08-		TC00511-RI	FW937K780AF		1
F-TYPE Cabriolet (X152)	400	294/400	2016/11-		TC00511-RI	FW937K780AF		1
F-TYPE Cabriolet (X152)	5.0 R	405/551	2014/12-		TC00511-RI	FW937K780AF		1
F-TYPE Cabriolet (X152)	5.0 SVR	423/575	2015/12-		TC00511-RI	FW937K780AF		1

## Jaguar - F-Type - F-TYPE Coupe (X152)



Img.1

### Gearbox, Powertrain - Transfer Case

F-TYPE Coupe (X152)	3.0 S	280/380	2014/12-		TC00511-RI	FW937K780AF		1
F-TYPE Coupe (X152)	3.0	250/340	2017/08-		TC00511-RI	FW937K780AF		1
F-TYPE Coupe (X152)	400	294/400	2016/11-		TC00511-RI	FW937K780AF		1
F-TYPE Coupe (X152)	5.0 R	405/551	2014/12-		TC00511-RI	FW937K780AF		1
F-TYPE Coupe (X152)	5.0 SVR	423/575	2015/12-		TC00511-RI	FW937K780AF		1

## Jaguar - XJ - XJ (X351)



Img.1

### Gearbox, Powertrain - Transfer Case

XJ (X351)	3.0	250/340	2015/10-		TC00511-RI	FW937K780AF		1
XJ (X351)	3.0	253/344	2015/10-		TC00511-RI	FW937K780AF		1

All rights reserved.

This publication may not be reproduced in any form, in whole or in part, without a written approval from S-TEC Service Technologies GmbH & Co OG.  
Subject to change without notice!

### Brand - Series - Sales Name

### Maingroup - Subgroup

Salesname	Model	kW/HP	Model Year	Gearbox	Part Number	OEM Number	Info	Image
-----------	-------	-------	------------	---------	-------------	------------	------	-------

### Land Rover - Discovery - DISCOVERY III (L319)



Img.1

### Gearbox, Powertrain - Transfer Case

DISCOVERY III (L319)	2.7 TD 4x4	140/190	2004/07-2009/09		TC00404-RI	LR006016; LR008206; LR049160		1
DISCOVERY III (L319)	2.7 TD 4x4	147/200	2004/07-2009/09		TC00404-RI	LR006016; LR008206; LR049160		1
DISCOVERY III (L319)	4.0 4x4	160/218	2005/02-2009/09		TC00404-RI	LR006016; LR008206; LR049160		1
DISCOVERY III (L319)	4.0 4x4	161/219	2005/02-2009/09		TC00404-RI	LR006016; LR008206; LR049160		1
DISCOVERY III (L319)	4.0 V6 4x4	156/212	2004/10-2009/09		TC00404-RI	LR006016; LR008206; LR049160		1
DISCOVERY III (L319)	4.0 V6 4x4	160/218	2004/10-2009/09		TC00404-RI	LR006016; LR008206; LR049160		1
DISCOVERY III (L319)	4.0 V6 4x4	161/219	2004/10-2007/12		TC00404-RI	LR006016; LR008206; LR049160		1
DISCOVERY III (L319)	4.4 4x4	220/299	2004/07-2009/09		TC00404-RI	LR006016; LR008206; LR049160		1
DISCOVERY III (L319)	4.4 4x4	224/305	2004/09-2009/09		TC00404-RI	LR006016; LR008206; LR049160		1

### Land Rover - Discovery - DISCOVERY III (TAA)



Img.1

### Gearbox, Powertrain - Transfer Case

DISCOVERY III (TAA)	2.7 TDV6	140/190	2004/10-2009/08		TC00404-RI	LR006016; LR008206; LR049160		1
DISCOVERY III (TAA)	4.0 V6	158/215	2004/10-2009/08		TC00404-RI	LR006016; LR008206; LR049160		1
DISCOVERY III (TAA)	4.4 V8	220/299	2004/10-2009/08		TC00404-RI	LR006016; LR008206; LR049160		1

All rights reserved.

This publication may not be reproduced in any form, in whole or in part, without a written approval from S-TEC Service Technologies GmbH & Co OG.  
Subject to change without notice!

### Brand - Series - Sales Name

### Maingroup - Subgroup

Salesname	Model	kW/HP	Model Year	Gearbox	Part Number	OEM Number	Info	Image
-----------	-------	-------	------------	---------	-------------	------------	------	-------

### Land Rover - Discovery - DISCOVERY IV (L319)



Img.1



Img.2

### Gearbox, Powertrain - Transfer Case

DISCOVERY IV (L319)	2.7 TD 4x4	140/190	2009/09-2013/07		TC00404-RI	LR006016; LR008206; LR049160		1
DISCOVERY IV (L319)	2.7 TD 4x4	140/190	2013/07-		TC00487-RI	LR089531		2
DISCOVERY IV (L319)	3.0 4x4	250/340	2013/08-2016/07		TC00488-RI	LR089529		
DISCOVERY IV (L319)	3.0 4x4	254/345	2012/09-2013/07		TC00404-RI	LR006016; LR008206; LR049160		1
DISCOVERY IV (L319)	3.0 4x4	254/345	2013/07-		TC00487-RI	LR089531		2
DISCOVERY IV (L319)	3.0 SDV6 4x4	188/256	2009/11-2013/07		TC00404-RI	LR006016; LR008206; LR049160		1
DISCOVERY IV (L319)	3.0 SDV6 4x4	188/256	2013/07-		TC00487-RI	LR089531		2
DISCOVERY IV (L319)	3.0 TD 4x4	155/211	2010/05-2013/07		TC00404-RI	LR006016; LR008206; LR049160		1
DISCOVERY IV (L319)	3.0 TD 4x4	155/211	2013/07-		TC00487-RI	LR089531		2
DISCOVERY IV (L319)	3.0 TD 4x4	180/245	2009/09-2013/07		TC00404-RI	LR006016; LR008206; LR049160		1
DISCOVERY IV (L319)	3.0 TD 4x4	180/245	2013/07-		TC00487-RI	LR089531		2
DISCOVERY IV (L319)	3.0 TD 4x4	183/249	2012/07-2013/07		TC00404-RI	LR006016; LR008206; LR049160		1
DISCOVERY IV (L319)	3.0 TD 4x4	183/249	2013/07-		TC00487-RI	LR089531		2
DISCOVERY IV (L319)	3.0 TD 4x4	200/272	2009/09-2013/07		TC00404-RI	LR006016; LR008206; LR049160		1
DISCOVERY IV (L319)	3.0 TD 4x4	200/272	2013/07-		TC00487-RI	LR089531		2
DISCOVERY IV (L319)	4.0 4x4	160/218	2009/09-2013/07		TC00404-RI	LR006016; LR008206; LR049160		1
DISCOVERY IV (L319)	4.0 4x4	160/218	2013/07-		TC00487-RI	LR089531		2
DISCOVERY IV (L319)	5.0 4x4	218/296	2009/09-2013/07		TC00404-RI	LR006016; LR008206; LR049160		1
DISCOVERY IV (L319)	5.0 4x4	218/296	2013/07-		TC00487-RI	LR089531		2
DISCOVERY IV (L319)	5.0 4x4	280/381	2009/09-2013/07		TC00404-RI	LR006016; LR008206; LR049160		1
DISCOVERY IV (L319)	5.0 4x4	280/381	2013/07-		TC00487-RI	LR089531		2
DISCOVERY IV (L319)	5.0 V8 4x4	276/375	2009/09-2013/07		TC00404-RI	LR006016; LR008206; LR049160		1

All rights reserved.

This publication may not be reproduced in any form, in whole or in part, without a written approval from S-TEC Service Technologies GmbH & Co OG.  
Subject to change without notice!

### Brand - Series - Sales Name

### Maingroup - Subgroup

Salesname	Model	kW/HP	Model Year	Gearbox	Part Number	OEM Number	Info	Image
-----------	-------	-------	------------	---------	-------------	------------	------	-------

### Land Rover - Discovery - DISCOVERY IV (L319)

#### Gearbox, Powertrain - Transfer Case

DISCOVERY IV (L319)	5.0 V8 4x4	276/375	2013/07-		TC00487-RI	LR089531		2
---------------------	------------	---------	----------	--	------------	----------	--	---

### Land Rover - Discovery - DISCOVERY V (L462)

#### Gearbox, Powertrain - Transfer Case

DISCOVERY V (L462)	2.0 Sd4 4x4	177/241	2016/09-		TC00545-RI	HPLA7K780BD; LR117096		
DISCOVERY V (L462)	2.0 Si4 4x4	221/300	2017/09-		TC00545-RI	HPLA7K780BD; LR117096		
DISCOVERY V (L462)	3.0 D 4x4	155/211	2016/09-		TC00545-RI	HPLA7K780BD; LR117096		
DISCOVERY V (L462)	3.0 SDV6 4x4	225/306	2018/09-		TC00545-RI	HPLA7K780BD; LR117096		

### Land Rover - Freelander - FREELANDER (L314)



Img.1

#### Gearbox, Powertrain - Transfer Case

FREELANDER (L314)	2.5 V6 4x4	130/177	2000/11-2006/10		TC00006-RI	TAG000220	6 cylinder engines No complete unit, only single parts available! For details please see 4WD Single Parts catalogue.	1
-------------------	------------	---------	-----------------	--	------------	-----------	---	---

All rights reserved.

This publication may not be reproduced in any form, in whole or in part, without a written approval from S-TEC Service Technologies GmbH & Co OG.  
Subject to change without notice!

## Brand - Series - Sales Name

### Maingroup - Subgroup

Salesname	Model	kW/HP	Model Year	Gearbox	Part Number	OEM Number	Info	Image
-----------	-------	-------	------------	---------	-------------	------------	------	-------

## Land Rover - Range Rover - RANGE ROVER III (L322)



Img.1



Img.2



Img.3

### Gearbox, Powertrain - Transfer Case

RANGE ROVER III (L322)	3.0 D 4x4	130/177	2002/03-2012/08		TC00012-RI	IAB000033		1
RANGE ROVER III (L322)	3.0 V6 4x4	250/340	2003/06-2012/08		TC00404-RI	LR006016; LR008206; LR049160		2
RANGE ROVER III (L322)	3.6 D 4x4	200/272	2006/04-2012/08		TC00404-RI	LR006016; LR008206; LR049160		2
RANGE ROVER III (L322)	4.2 4x4	291/396	2005/05-2012/08		TC00404-RI	LR006016; LR008206; LR049160		2
RANGE ROVER III (L322)	4.2 Supercharged 4x4	298/405	2005/09-2009/12		TC00404-RI	LR006016; LR008206; LR049160		2
RANGE ROVER III (L322)	4.4 4x4	210/286	2002/03-2005/08		TC00012-RI	IAB000033		1
RANGE ROVER III (L322)	4.4 4x4	212/288	2004/09-2005/12		TC00404-RI	LR006016; LR008206; LR049160		2
RANGE ROVER III (L322)	4.4 4x4	220/299	2004/08-2012/08		TC00404-RI	LR006016; LR008206; LR049160		2
RANGE ROVER III (L322)	4.4 4x4	224/305	2002/09-2009/12		TC00404-RI	LR006016; LR008206; LR049160		2
RANGE ROVER III (L322)	4.4 4x4	225/306	2005/05-2012/08		TC00404-RI	LR006016; LR008206; LR049160		2
RANGE ROVER III (L322)	4.4 D 4x4	230/313	2010/07-2012/08		TC00404-RI	LR006016; LR008206; LR049160		2
RANGE ROVER III (L322)	5.0 4x4	218/296	2009/09-2012/08		TC00404-RI	LR006016; LR008206; LR049160		2
RANGE ROVER III (L322)	5.0 4x4	276/375	2009/09-2012/08		TC00404-RI	LR006016; LR008206; LR049160		2
RANGE ROVER III (L322)	5.0 4x4	375/510	2009/09-2012/08		TC00487-RI	LR089531		3

All rights reserved.

This publication may not be reproduced in any form, in whole or in part, without a written approval from S-TEC Service Technologies GmbH & Co OG.  
Subject to change without notice!



## Brand - Series - Sales Name

### Maingroup - Subgroup

Salesname	Model	kW/HP	Model Year	Gearbox	Part Number	OEM Number	Info	Image
-----------	-------	-------	------------	---------	-------------	------------	------	-------

## Land Rover - Range Rover - RANGE ROVER III (LM)



Img.1



Img.2

### Gearbox, Powertrain - Transfer Case

RANGE ROVER III (LM)	3.0 TD6	130/177	2002/01-2006/12		TC00012-RI	IAB000033		1
RANGE ROVER III (LM)	3.8 TDV8	200/272	2006/01-2010/06		TC00404-RI	LR006016; LR008206; LR049160		2
RANGE ROVER III (LM)	4.2 V8 Supercharged	291/396	2005/01-2009/12		TC00404-RI	LR006016; LR008206; LR049160		2
RANGE ROVER III (LM)	4.4 V8 SE	225/306	2006/01-2007/12		TC00404-RI	LR006016; LR008206; LR049160		2
RANGE ROVER III (LM)	4.4 V8	210/286	2002/01-2005/12		TC00012-RI	IAB000033		1
RANGE ROVER III (LM)	5.0 V8 HSE	276/375	2009/01-2012/12		TC00404-RI	LR006016; LR008206; LR049160		2
RANGE ROVER III (LM)	5.0 V8 Supercharged	375/510	2009/01-2012/12		TC00404-RI	LR006016; LR008206; LR049160		2

## Land Rover - Range Rover - RANGE ROVER IV (L405)



Img.1

### Gearbox, Powertrain - Transfer Case

RANGE ROVER IV (L405)	3.0 SCV6 4x4	280/380	2015/06-		TC00545-RI	HPLA7K780BD; LR117096		
RANGE ROVER IV (L405)	5.0 4x4	375/510	2012/08-2013/08		TC00404-RI	LR006016; LR008206; LR049160		1
RANGE ROVER IV (L405)	5.0 4x4	375/510	2013/08-2016/07		TC00488-RI	LR089529		
RANGE ROVER IV (L405)	5.0 SCV8 4x4	386/525	2017/11-		TC00545-RI	HPLA7K780BD; LR117096		
RANGE ROVER IV (L405)	5.0 SCV8 4x4	416/566	2017/11-		TC00545-RI	HPLA7K780BD; LR117096		

All rights reserved.

This publication may not be reproduced in any form, in whole or in part, without a written approval from S-TEC Service Technologies GmbH & Co OG.  
Subject to change without notice!

## Brand - Series - Sales Name

### Maingroup - Subgroup

Salesname	Model	kW/HP	Model Year	Gearbox	Part Number	OEM Number	Info	Image
-----------	-------	-------	------------	---------	-------------	------------	------	-------

## Land Rover - Range Rover - RANGE ROVER SPORT (L320)



Img.1

### Gearbox, Powertrain - Transfer Case

RANGE ROVER SPORT (L320)	2.7 D 4x4	140/190	2005/02-2013/03		TC00404-RI	LR006016; LR008206; LR049160		1
RANGE ROVER SPORT (L320)	3.0 D 4x4	155/211	2010/05-2013/03		TC00404-RI	LR006016; LR008206; LR049160		1
RANGE ROVER SPORT (L320)	3.0 D 4x4	180/245	2009/09-2013/03		TC00404-RI	LR006016; LR008206; LR049160		1
RANGE ROVER SPORT (L320)	3.0 D 4x4	183/249	2012/08-2013/03		TC00404-RI	LR006016; LR008206; LR049160		1
RANGE ROVER SPORT (L320)	3.0 D 4x4	188/256	2011/06-2013/03		TC00404-RI	LR006016; LR008206; LR049160		1
RANGE ROVER SPORT (L320)	3.6 D 4x4	200/272	2006/04-2013/03		TC00404-RI	LR006016; LR008206; LR049160		1
RANGE ROVER SPORT (L320)	4.2 4x4	287/390	2005/02-2013/03		TC00404-RI	LR006016; LR008206; LR049160		1
RANGE ROVER SPORT (L320)	4.4 4x4	220/299	2005/02-2013/03		TC00404-RI	LR006016; LR008206; LR049160		1
RANGE ROVER SPORT (L320)	5.0 4x4	218/297	2009/09-2013/03		TC00404-RI	LR006016; LR008206; LR049160		1
RANGE ROVER SPORT (L320)	5.0 4x4	276/375	2009/07-2013/03		TC00404-RI	LR006016; LR008206; LR049160		1
RANGE ROVER SPORT (L320)	5.0 4x4	280/381	2009/07-2013/03		TC00404-RI	LR006016; LR008206; LR049160		1
RANGE ROVER SPORT (L320)	5.0 4x4	372/506	2009/04-2013/03		TC00404-RI	LR006016; LR008206; LR049160		1
RANGE ROVER SPORT (L320)	5.0 4x4	375/510	2009/09-2013/03		TC00404-RI	LR006016; LR008206; LR049160		1

## Land Rover - Range Rover - RANGE ROVER SPORT II (L494)

### Gearbox, Powertrain - Transfer Case

RANGE ROVER SPORT II (L494)	3.0 SCV6 4x4	254/345	2014/01-2019/12		TC00545-RI	HPLA7K780BD; LR117096		
RANGE ROVER SPORT II (L494)	3.0 SDV6 4x4	225/306	2014/09-		TC00545-RI	HPLA7K780BD; LR117096		
RANGE ROVER SPORT II (L494)	5.0 SCV8 4x4	386/525	2017/11-		TC00545-RI	HPLA7K780BD; LR117096		

All rights reserved.

This publication may not be reproduced in any form, in whole or in part, without a written approval from S-TEC Service Technologies GmbH & Co OG.  
Subject to change without notice!

## Brand - Series - Sales Name

### Maingroup - Subgroup

Salesname	Model	kW/HP	Model Year	Gearbox	Part Number	OEM Number	Info	Image
-----------	-------	-------	------------	---------	-------------	------------	------	-------

## Maserati - Ghibli - Ghibli III (M157)



Img.1

### Gearbox, Powertrain - Transfer Case

GHIBLI III (M157)	3.0 S Q4	301/409	2013/08-		TC00513-RI	673009767		1
GHIBLI III (M157)	3.0 S Q4	316/430	2017/07-		TC00514-RI	670152725		1

## Maserati - Levante - LEVANTE



Img.1

### Gearbox, Powertrain - Transfer Case

LEVANTE	3.0	257/350	2016/06-		TC00528-RI	670152726		1
LEVANTE	3.0 D	184/250	2016/06-		TC00528-RI	670152726		1
LEVANTE	3.0 D	202/275	2016/06-		TC00528-RI	670152726		1
LEVANTE	3.0 S	316/430	2016/06-		TC00528-RI	670152726		1

## Maserati - Quattroporte - QUATTROPORTE VI



Img.1

### Gearbox, Powertrain - Transfer Case

QUATTROPORTE VI	3.0 S Q4	302/411	2013/05-		TC00513-RI	673009767		1
QUATTROPORTE VI	3.0 S Q4	301/409	2016/11-		TC00513-RI	673009767		1
QUATTROPORTE VI	3.0 S Q4	306/416	2013/05-		TC00513-RI	673009767		1
QUATTROPORTE VI	3.0 S Q4	316/430	2017/07-		TC00514-RI	670152725		1

All rights reserved.

This publication may not be reproduced in any form, in whole or in part, without a written approval from S-TEC Service Technologies GmbH & Co OG.  
Subject to change without notice!

### Brand - Series - OEM Model

### Maingroup - Subgroup

Salesname	Model	kW/HP	Model Year	Gearbox	Part Number	OEM Number	Info	Image
-----------	-------	-------	------------	---------	-------------	------------	------	-------

### Mercedes-Benz - A-Class - (176) W176



Img.1

#### Rear Axle - Rear Differential

A 200 CDI / d 4-matic (176.002)	(176) W176	100/136	2014/02-		RD00098-RI	A1763503100		1
A 220 CDI 4-matic (176.005)	(176) W176	125/170	2012/09-		RD00098-RI	A1763503100		1
A 220 d 4-matic (176.005)	(176) W176	130/177	2015/07-		RD00098-RI	A1763503100		1
A 220 4-matic (176.047)	(176) W176	135/184	2014/05-		RD00098-RI	A1763503100		1
A 250 4-matic (176.046)	(176) W176	155/211	2012/06-2015/06		RD00098-RI	A1763503100		1
A 250 4-matic (176.051)	(176) W176	160/218	2015/07-		RD00098-RI	A1763503100		1
A 45 AMG 4-matic (176.052)	(176) W176	265/360	2013/06-2015/06		RD00098-RI	A1763503100		1
A 45 4-matic (176.052)	(176) W176	280/381	2015/07-		RD00098-RI	A1763503100		1

### Mercedes-Benz - B-Class - (246, 242) W246, W242



Img.1

#### Rear Axle - Rear Differential

B 200 CDI / d 4-matic (246.202)	(246, 242) W246, W242	100/136	2014/08-		RD00098-RI	A1763503100		1
B 220 CDI / d 4-matic (246.205)	(246, 242) W246, W242	130/177	2014/09-		RD00098-RI	A1763503100		1
B 220 4-matic (246.247)	(246, 242) W246, W242	135/184	2013/05-		RD00098-RI	A1763503100		1
B 250 4-matic (246.246)	(246, 242) W246, W242	155/211	2014/08-		RD00098-RI	A1763503100		1

All rights reserved.

This publication may not be reproduced in any form, in whole or in part, without a written approval from S-TEC Service Technologies GmbH & Co OG.  
Subject to change without notice!

## Brand - Series - OEM Model

### Maingroup - Subgroup

Salesname	Model	kW/HP	Model Year	Gearbox	Part Number	OEM Number	Info	Image
-----------	-------	-------	------------	---------	-------------	------------	------	-------

## Mercedes-Benz - C-Class - (203) S203



Img.1

### Gearbox, Powertrain - Transfer Case

C 240 4-matic (203.281)	(203) S203	125/170	2002/07-2007/08		TC00210-RI	A2032800700		1
C 320 4-matic (203.284)	(203) S203	160/218	2002/07-2007/08		TC00210-RI	A2032800700		1
C 280 4-matic (203.292)	(203) S203	170/231	2005/01-2007/08		TC00210-RI	A2032800700		1
C 350 4-matic (203.287)	(203) S203	200/272	2005/01-2007/08		TC00210-RI	A2032800700		1

## Mercedes-Benz - C-Class - (203) W203



Img.1

### Gearbox, Powertrain - Transfer Case

C 240 4-matic (203.081)	(203) W203	125/170	2002/07-2007/02		TC00210-RI	A2032800700		1
C 320 4-matic (203.084)	(203) W203	160/218	2002/07-2007/02		TC00210-RI	A2032800700		1
C 280 4-matic (203.092)	(203) W203	170/231	2005/01-2007/02		TC00210-RI	A2032800700		1
C 350 4-matic (203.087)	(203) W203	200/272	2005/01-2007/02		TC00210-RI	A2032800700		1

All rights reserved.

This publication may not be reproduced in any form, in whole or in part, without a written approval from S-TEC Service Technologies GmbH & Co OG.  
Subject to change without notice!

## Brand - Series - OEM Model

### Maingroup - Subgroup

Salesname	Model	kW/HP	Model Year	Gearbox	Part Number	OEM Number	Info	Image
-----------	-------	-------	------------	---------	-------------	------------	------	-------

## Mercedes-Benz - CLA-Class - (117) C117



Img.1

### Rear Axle - Rear Differential

CLA 200 CDI / d 4-matic (117.302)	(117) C117	100/136	2014/07-		RD00098-RI	A1763503100		1
CLA 220 CDI / d 4-matic (117.305)	(117) C117	120/163	2014/08-		RD00098-RI	A1763503100		1
CLA 220 CDI 4-matic (117.305)	(117) C117	125/170	2014/07-		RD00098-RI	A1763503100		1
CLA 220 CDI / d 4-matic (117.305)	(117) C117	130/177	2014/09-		RD00098-RI	A1763503100		1
CLA 220 4-matic (117.347)	(117) C117	135/184	2016/04-		RD00098-RI	A1763503100		1
CLA 250 4-matic (117.346)	(117) C117	155/211	2013/07-		RD00098-RI	A1763503100		1
CLA A 250 4-matic (117.351)	(117) C117	160/218	2015/07-		RD00098-RI	A1763503100		1
CLA 45 AMG 4-matic (117.352)	(117) C117	265/360	2013/07-		RD00098-RI	A1763503100		1
CLA 45 4-matic (117.352)	(117) C117	280/381	2015/07-		RD00098-RI	A1763503100		1

## Mercedes-Benz - CLA-Class - (117) X117



Img.1

### Rear Axle - Rear Differential

CLA 200 CDI / d 4-matic (117.902)	(117) X117	100/136	2015/01-		RD00098-RI	A1763503100		1
CLA 220 CDI / d 4-matic (117.905)	(117) X117	120/163	2015/09-		RD00098-RI	A1763503100		1
CLA 220 d 4-matic (117.905)	(117) X117	125/170	2018/07-2019/03		RD00098-RI	A1763503100		1
CLA 220 CDI / d 4-matic (117.905)	(117) X117	130/177	2015/01-		RD00098-RI	A1763503100		1
CLA 220 4-matic (117.947)	(117) X117	135/184	2016/04-		RD00098-RI	A1763503100		1
CLA 250 4-matic (117.946)	(117) X117	155/211	2015/01-		RD00098-RI	A1763503100		1
CLA 250 4-matic (117.951)	(117) X117	160/218	2015/07-		RD00098-RI	A1763503100		1
CLA 45 AMG 4-matic (117.952)	(117) X117	265/360	2015/01-2015/06		RD00098-RI	A1763503100		1
CLA 45 4-matic (117.952)	(117) X117	280/381	2015/07-		RD00098-RI	A1763503100		1

All rights reserved.

This publication may not be reproduced in any form, in whole or in part, without a written approval from S-TEC Service Technologies GmbH & Co OG.  
Subject to change without notice!

### Brand - Series - OEM Model

#### Maingroup - Subgroup

Salesname	Model	kW/HP	Model Year	Gearbox	Part Number	OEM Number	Info	Image
-----------	-------	-------	------------	---------	-------------	------------	------	-------

### Mercedes-Benz - E-Class - (210) S210



Img.1

#### Gearbox, Powertrain - Transfer Case

E 280 T 4-matic (210.281)	(210) S210	150/204	1996/12-1999/12		TC00014-RI	A2102800100		1
E 320 T 4-matic (210.282)	(210) S210	165/224	1996/12-2003/03		TC00014-RI	A2102800100		1

### Mercedes-Benz - E-Class - (210) W210



Img.1

#### Gearbox, Powertrain - Transfer Case

E 280 4-matic (210.081)	(210) W210	150/204	1996/12-1999/12		TC00014-RI	A2102800100		1
E 320 4-matic (210.082)	(210) W210	160/218	1997/09-1998/12		TC00014-RI	A2102800100		1
E 320 4-matic (210.082)	(210) W210	165/224	1997/06-2002/03		TC00014-RI	A2102800100		1

### Mercedes-Benz - E-Class - (211) S211



Img.1

#### Gearbox, Powertrain - Transfer Case

E 240 T 4-matic (211.280)	(211) S211	130/177	2003/07-2009/07		TC00210-RI	A2032800700		1
E 280 T CDI 4-matic (211.284)	(211) S211	140/190	2005/03-2009/07		TC00187-RI	A2112801000		1
E 320 T 4-matic (211.282)	(211) S211	165/224	2003/07-2009/07		TC00210-RI	A2032800700		1
E 320 T CDI 4-matic (211.289)	(211) S211	165/224	2005/03-2009/07		TC00187-RI	A2112801000		1
E 280 T 4-matic (211.292)	(211) S211	170/231	2005/03-2009/07		TC00203-RI	A2112800900		1
E 350 T 4-matic (211.287)	(211) S211	200/272	2005/03-2009/07		TC00203-RI	A2112800900		1
E 500 T 4-matic (211.283)	(211) S211	225/306	2003/10-2009/07		TC00185-RI	A2202800700		1
E 500 T 4-matic (211.290)	(211) S211	285/388	2006/04-2009/07		TC00187-RI	A2112801000		1

All rights reserved.

This publication may not be reproduced in any form, in whole or in part, without a written approval from S-TEC Service Technologies GmbH & Co OG.  
Subject to change without notice!

### Brand - Series - OEM Model

### Maingroup - Subgroup

Salesname	Model	kW/HP	Model Year	Gearbox	Part Number	OEM Number	Info	Image
-----------	-------	-------	------------	---------	-------------	------------	------	-------

### Mercedes-Benz - E-Class - (211) W211



Img.1

### Gearbox, Powertrain - Transfer Case

E 240 4-matic (211.080)	(211) W211	130/177	2003/03-2008/12		TC00210-RI	A2032800700		1
E 280 CDI 4-matic (211.084)	(211) W211	140/190	2005/03-2008/12		TC00187-RI	A2112801000		1
E 320 4-matic (211.082)	(211) W211	165/224	2003/03-2008/12		TC00210-RI	A2032800700		1
E 320 CDI 4-matic (211.089)	(211) W211	165/224	2005/03-2008/12		TC00187-RI	A2112801000		1
E 280 4-matic (211.092)	(211) W211	170/231	2006/01-2008/12		TC00203-RI	A2112800900		1
E 350 4-matic (211.087)	(211) W211	200/272	2005/03-2008/12		TC00203-RI	A2112800900		1
E 500 4-matic (211.083)	(211) W211	225/306	2003/10-2008/12		TC00185-RI	A2202800700		1
E 500 4-matic (211.090)	(211) W211	285/388	2006/04-2008/12		TC00187-RI	A2112801000		1

All rights reserved.

This publication may not be reproduced in any form, in whole or in part, without a written approval from S-TEC Service Technologies GmbH & Co OG.  
Subject to change without notice!



### Brand - Series - OEM Model

### Maingroup - Subgroup

Salesname	Model	kW/HP	Model Year	Gearbox	Part Number	OEM Number	Info	Image
-----------	-------	-------	------------	---------	-------------	------------	------	-------

### Mercedes-Benz - G-Class - (460) W460



Img.1

### Gearbox, Powertrain - Transfer Case

280 GE (460.212, 460.243)	(460) W460	110/150	1982/07-1993/05		TC00019-RI	A4602803600		1
280 GE (460.232)	(460) W460	110/150	1984/08-1989/08		TC00019-RI	A4602803600		1
280 GE (460.233)	(460) W460	110/150	1984/08-1989/08		TC00019-RI	A4602803600		1
280 GE (460.243)	(460) W460	110/150	1984/08-1989/08		TC00019-RI	A4602803600		1
280 GE (460.212)	(460) W460	110/150	1984/08-1989/08		TC00019-RI	A4602803600		1
280 GE (460.223)	(460) W460	110/150	1984/08-1989/08		TC00019-RI	A4602803600		1
280 GE (460,2)	(460) W460	110/150	1984/08-1989/08		TC00019-RI	A4602803600		1
280 GE (460.224)	(460) W460	110/150	1984/08-1989/08		TC00019-RI	A4602803600		1
280 GE (460.222)	(460) W460	110/150	1984/08-1989/08		TC00019-RI	A4602803600		1
280 GE (460.212, 460.243)	(460) W460	115/156	1979/11-1982/06		TC00019-RI	A4602803600		1
240 GD (460.330)	(460) W460	53/72	1979/03-1987/08		TC00019-RI	A4602803600		1
240 GD (460.341)	(460) W460	53/72	1979/03-1987/08		TC00019-RI	A4602803600		1
240 GD (460.331)	(460) W460	53/72	1979/03-1987/08		TC00019-RI	A4602803600		1
240 GD (460.320)	(460) W460	53/72	1979/03-1987/08		TC00019-RI	A4602803600		1
240 GD (460,3)	(460) W460	53/72	1979/03-1987/08		TC00019-RI	A4602803600		1
240 GD (460.321)	(460) W460	53/72	1979/03-1987/08		TC00019-RI	A4602803600		1
240 GD (460.310)	(460) W460	53/72	1979/03-1987/08		TC00019-RI	A4602803600		1
240 GD (460.310, 460.341)	(460) W460	53/72	1979/03-1989/08		TC00019-RI	A4602803600		1
250 GD (460.317)	(460) W460	62/84	1987/10-1992/12		TC00019-RI	A4602803600		1
250 GD (460.328)	(460) W460	62/84	1987/10-1992/12		TC00019-RI	A4602803600		1
250 GD (460.329)	(460) W460	62/84	1987/10-1992/12		TC00019-RI	A4602803600		1
250 GD (460,3)	(460) W460	62/84	1987/10-1992/12		TC00019-RI	A4602803600		1
250 GD (460.337)	(460) W460	62/84	1987/10-1992/12		TC00019-RI	A4602803600		1
250 GD (460.338)	(460) W460	62/84	1987/10-1992/12		TC00019-RI	A4602803600		1
300 GD (460.312, 460.343)	(460) W460	65/88	1979/11-1989/08		TC00019-RI	A4602803600		1
300 GD (460.323)	(460) W460	65/88	1979/12-1991/12		TC00019-RI	A4602803600		1
300 GD (460.322)	(460) W460	65/88	1979/12-1991/12		TC00019-RI	A4602803600		1
300 GD (460.343)	(460) W460	65/88	1979/12-1991/12		TC00019-RI	A4602803600		1
300 GD (460.325)	(460) W460	65/88	1979/12-1991/12		TC00019-RI	A4602803600		1
300 GD (460.332)	(460) W460	65/88	1979/12-1991/12		TC00019-RI	A4602803600		1
300 GD (460,3)	(460) W460	65/88	1979/12-1991/12		TC00019-RI	A4602803600		1
300 GD (460.312)	(460) W460	65/88	1979/12-1991/12		TC00019-RI	A4602803600		1
300 GD (460.333)	(460) W460	65/88	1979/12-1991/12		TC00019-RI	A4602803600		1
230 G (460.210, 460.241)	(460) W460	66/90	1980/02-1987/07		TC00019-RI	A4602803600		1
250 GD (460,3)	(460) W460	68/92	1988/12-1992/08		TC00019-RI	A4602803600		1
230 G (460.230)	(460) W460	75/102	1980/02-1987/07		TC00019-RI	A4602803600		1
230 G (460.210)	(460) W460	75/102	1980/02-1987/07		TC00019-RI	A4602803600		1
230 G (460.241)	(460) W460	75/102	1980/02-1987/07		TC00019-RI	A4602803600		1
230 G (460.231)	(460) W460	75/102	1980/02-1987/07		TC00019-RI	A4602803600		1
230 G (460,2)	(460) W460	75/102	1980/02-1987/07		TC00019-RI	A4602803600		1
230 G (460.220)	(460) W460	75/102	1980/02-1987/07		TC00019-RI	A4602803600		1
230 G (460.221)	(460) W460	75/102	1980/02-1987/07		TC00019-RI	A4602803600		1
200 GE (460.216)	(460) W460	80/109	1982/07-1989/08		TC00019-RI	A4602803600		1
200 GE (460.237)	(460) W460	80/113	1980/01-1991/12		TC00019-RI	A4602803600		1
200 GE (460.236)	(460) W460	80/113	1980/01-1991/12		TC00019-RI	A4602803600		1
200 GE (460.216)	(460) W460	80/113	1980/01-1991/12		TC00019-RI	A4602803600		1

All rights reserved.

This publication may not be reproduced in any form, in whole or in part, without a written approval from S-TEC Service Technologies GmbH & Co OG.  
Subject to change without notice!

### Brand - Series - OEM Model

### Maingroup - Subgroup

Salesname	Model	kW/HP	Model Year	Gearbox	Part Number	OEM Number	Info	Image
-----------	-------	-------	------------	---------	-------------	------------	------	-------

### Mercedes-Benz - G-Class - (460) W460

### Gearbox, Powertrain - Transfer Case

230 GE (460.218, 460.249)	(460) W460	90/122	1986/08-1993/05		TC00019-RI	A4602803600		1
230 GE (460.218)	(460) W460	92/125	1980/01-1991/12		TC00019-RI	A4602803600		1
230 GE (460,2)	(460) W460	92/125	1982/04-1992/08		TC00019-RI	A4602803600		1
230 GE (460.218, 460.249)	(460) W460	92/125	1982/07-1993/05		TC00019-RI	A4602803600		1
230 GE (460.228)	(460) W460	92/125	1987/05-1992/08		TC00019-RI	A4602803600		1
230 GE (460.238)	(460) W460	92/125	1987/05-1992/08		TC00019-RI	A4602803600		1
230 GE (460.249)	(460) W460	92/125	1987/05-1992/08		TC00019-RI	A4602803600		1
230 GE (460.229)	(460) W460	92/125	1987/05-1992/08		TC00019-RI	A4602803600		1
230 GE (460.239)	(460) W460	92/125	1987/05-1992/08		TC00019-RI	A4602803600		1
230 GE (460.227)	(460) W460	92/125	1987/05-1992/08		TC00019-RI	A4602803600		1

All rights reserved.

This publication may not be reproduced in any form, in whole or in part, without a written approval from S-TEC Service Technologies GmbH & Co OG.  
Subject to change without notice!

## Brand - Series - OEM Model

### Maingroup - Subgroup

Salesname	Model	kW/HP	Model Year	Gearbox	Part Number	OEM Number	Info	Image
-----------	-------	-------	------------	---------	-------------	------------	------	-------

## Mercedes-Benz - G-Class - (461) W461



Img.1



Img.2

### Gearbox, Powertrain - Transfer Case

280 GE (461.212)	(461) W461	110/150	1992/01-2001/12		TC00019-RI	A4602803600		1
280 GE (461.213)	(461) W461	110/150	1992/01-2001/12		TC00019-RI	A4602803600		1
G 270 CDI (461.345)	(461) W461	115/156	2001/01-2006/12		TC00023-RI	A4632801700		2
G 270 CDI (461.302)	(461) W461	115/156	2001/01-2006/12		TC00023-RI	A4632801700		2
G 270 CDI (461.331)	(461) W461	115/156	2001/01-2006/12		TC00023-RI	A4632801700		2
G 270 CDI (461.342)	(461) W461	115/156	2001/01-2006/12		TC00023-RI	A4632801700		2
G 270 CDI (461.332)	(461) W461	115/156	2001/01-2006/12		TC00023-RI	A4632801700		2
G 280 CDI (461.3)	(461) W461	135/184	2007/01-		TC00019-RI	A4602803600		1
G 280 CDI (461.304, 461.334, 461.339, ...)	(461) W461	135/184	2009/04-		TC00023-RI	A4632801700		2
G 280 CDI (461.304, 461.334, 461.339, ...)	(461) W461	135/184	2009/04-		TC00019-RI	A4602803600		1
G 300 CDI (461.333)	(461) W461	135/184	2010/04-2023/07		TC00023-RI	A4632801700		2
240 GD (461.310)	(461) W461	53/72	1992/01-2001/12		TC00019-RI	A4602803600		1
240 GD (461.311)	(461) W461	53/72	1992/01-2001/12		TC00019-RI	A4602803600		1
250 GD (461.401)	(461) W461	62/84	1990/02-2001/12		TC00019-RI	A4602803600		1
250 GD (461.402)	(461) W461	62/84	1990/02-2001/12		TC00019-RI	A4602803600		1
250 GD (461.318)	(461) W461	62/84	1990/02-2001/12		TC00019-RI	A4602803600		1
250 GD (461.317)	(461) W461	62/84	1990/02-2001/12		TC00019-RI	A4602803600		1
250 GD/290 GD (461.450)	(461) W461	62/84	1997/07-2001/12		TC00019-RI	A4602803600		1
250 GD/290 GD (461.456)	(461) W461	62/84	1997/07-2001/12		TC00019-RI	A4602803600		1
250 GD/290 GD (461.459)	(461) W461	62/84	1997/07-2001/12		TC00019-RI	A4602803600		1
250 GD/290 GD (461.458)	(461) W461	62/84	1997/07-2001/12		TC00019-RI	A4602803600		1
250 GD/290 GD (461.452)	(461) W461	62/84	1997/07-2001/12		TC00019-RI	A4602803600		1
250 GD (461)	(461) W461	68/92	1990/02-1993/05		TC00019-RI	A4602803600		1
250 GD (461.317)	(461) W461	68/92	1990/02-2001/12		TC00019-RI	A4602803600		1
250 GD (461.318)	(461) W461	68/92	1990/02-2001/12		TC00019-RI	A4602803600		1
290 GD (461.338)	(461) W461	70/95	1992/04-2001/12		TC00019-RI	A4602803600		1
290 GD (461.341)	(461) W461	70/95	1992/04-2001/12		TC00019-RI	A4602803600		1
290 GD (461.403)	(461) W461	70/95	1992/04-2001/12		TC00019-RI	A4602803600		1
290 GD (461.451)	(461) W461	70/95	1992/04-2001/12		TC00019-RI	A4602803600		1
290 GD (461.405)	(461) W461	70/95	1992/04-2001/12		TC00019-RI	A4602803600		1
290 GD (461.454)	(461) W461	70/95	1992/04-2001/12		TC00019-RI	A4602803600		1
290 GD (461.329)	(461) W461	70/95	1992/04-2001/12		TC00019-RI	A4602803600		1
290 GD (461.368)	(461) W461	70/95	1992/04-2001/12		TC00019-RI	A4602803600		1
290 GD (461.455)	(461) W461	70/95	1992/04-2001/12		TC00019-RI	A4602803600		1
290 GD (461.337)	(461) W461	70/95	1992/04-2001/12		TC00019-RI	A4602803600		1
290 GD (461.323)	(461) W461	70/95	1992/04-2001/12		TC00019-RI	A4602803600		1
290 GD (461.367)	(461) W461	70/95	1992/04-2001/12		TC00019-RI	A4602803600		1

All rights reserved.

This publication may not be reproduced in any form, in whole or in part, without a written approval from S-TEC Service Technologies GmbH & Co OG.  
Subject to change without notice!

### Brand - Series - OEM Model

#### Maingroup - Subgroup

Salesname	Model	kW/HP	Model Year	Gearbox	Part Number	OEM Number	Info	Image
-----------	-------	-------	------------	---------	-------------	------------	------	-------

### Mercedes-Benz - G-Class - (461) W461

#### Gearbox, Powertrain - Transfer Case

290 GD (461.328)	(461) W461	70/95	1992/04-2001/12		TC00019-RI	A4602803600		1
300 GD (461.348)	(461) W461	83/113	1991/01-2001/12		TC00019-RI	A4602803600		1
300 GD (461.349)	(461) W461	83/113	1991/01-2001/12		TC00019-RI	A4602803600		1
300 GD (461.347)	(461) W461	83/113	1992/01-2001/12		TC00019-RI	A4602803600		1
300 GD (461.325)	(461) W461	83/113	1992/01-2001/12		TC00019-RI	A4602803600		1
300 GD (461.312)	(461) W461	83/113	1992/01-2001/12		TC00019-RI	A4602803600		1
300 GD (461.313)	(461) W461	83/113	1992/01-2001/12		TC00019-RI	A4602803600		1
G 290 TD (461.335, 461.336)	(461) W461	88/120	1997/07-2001/07		TC00019-RI	A4602803600		1
290 GDT (461.326)	(461) W461	88/120	1997/07-2001/12		TC00019-RI	A4602803600		1
290 GDT (461.322)	(461) W461	88/120	1997/07-2001/12		TC00019-RI	A4602803600		1
290 GDT (461.321)	(461) W461	88/120	1997/07-2001/12		TC00019-RI	A4602803600		1
290 GDT (461.366)	(461) W461	88/120	1997/07-2001/12		TC00019-RI	A4602803600		1
290 GDT (461.336)	(461) W461	88/120	1997/07-2001/12		TC00019-RI	A4602803600		1
290 GDT (461.327)	(461) W461	88/120	1997/07-2001/12		TC00019-RI	A4602803600		1
290 GDT (461.365)	(461) W461	88/120	1997/07-2001/12		TC00019-RI	A4602803600		1
290 GDT (461.335)	(461) W461	88/120	1997/07-2001/12		TC00019-RI	A4602803600		1
230 GE (461.238)	(461) W461	92/125	1993/02-2001/12		TC00019-RI	A4602803600		1
230 GE (461.217)	(461) W461	92/125	1993/02-2001/12		TC00019-RI	A4602803600		1
230 GE (461.249)	(461) W461	92/125	1993/02-2001/12		TC00019-RI	A4602803600		1
230 GE (461.227)	(461) W461	92/125	1993/02-2001/12		TC00019-RI	A4602803600		1
230 GE (461.219)	(461) W461	92/125	1993/02-2001/12		TC00019-RI	A4602803600		1
230 GE (461.229)	(461) W461	92/125	1993/02-2001/12		TC00019-RI	A4602803600		1
230 GE (461.266)	(461) W461	92/125	1993/02-2001/12		TC00019-RI	A4602803600		1
230 GE (461.239)	(461) W461	92/125	1993/02-2001/12		TC00019-RI	A4602803600		1
230 GE (461.218)	(461) W461	92/125	1993/02-2001/12		TC00019-RI	A4602803600		1
230 GE (461.267)	(461) W461	92/125	1993/02-2001/12		TC00019-RI	A4602803600		1
230 GE (461)	(461) W461	92/125	1993/06-2000/07		TC00019-RI	A4602803600		1
230 G (461.210)	(461) W461	93/126	1993/02-2001/12		TC00019-RI	A4602803600		1
230 G (461.211)	(461) W461	93/126	1993/02-2001/12		TC00019-RI	A4602803600		1

All rights reserved.

This publication may not be reproduced in any form, in whole or in part, without a written approval from S-TEC Service Technologies GmbH & Co OG.  
Subject to change without notice!

## Brand - Series - OEM Model

### Maingroup - Subgroup

Salesname	Model	kW/HP	Model Year	Gearbox	Part Number	OEM Number	Info	Image
-----------	-------	-------	------------	---------	-------------	------------	------	-------

## Mercedes-Benz - G-Class - (463) W463



Img.1



Img.2



Img.3



Img.4

### Gearbox, Powertrain - Transfer Case

350 Turbo GD (463.320, 463.321)	(463) W463	100/136	1991/09-1996/08		TC00276-RI	A4632801000		1
350 GD Turbo (463.321)	(463) W463	100/136	1992/01-1997/12		TC00276-RI	A4632801000		1
350 GD Turbo (463.320)	(463) W463	100/136	1992/01-1997/12		TC00276-RI	A4632801000		1
350 GD Turbo (463.300)	(463) W463	100/136	1992/01-1997/12		TC00276-RI	A4632801000		1
G 270 CDI (463.322, 463.323)	(463) W463	115/156	2001/10-2003/07		TC00023-RI	A4632801700		2
G 270 CDI (463.322)	(463) W463	115/156	2001/10-2006/12		TC00023-RI	A4632801700		2
G 270 CDI (463.323)	(463) W463	115/156	2001/10-2006/12		TC00023-RI	A4632801700		2
300 GE (463.227, 463.228)	(463) W463	125/170	1989/09-1993/08		TC00278-RI	A4632801400		1
300 GE (463.227, 463.228)	(463) W463	125/170	1989/09-1993/08		TC00276-RI	A4632801000		1
300 GE/G300; 500GE/G5 (463.228)	(463) W463	125/170	1990/01-1994/12		TC00276-RI	A4632801000		1
300 GE/G300 (463.227)	(463) W463	125/170	1990/01-1994/12		TC00278-RI	A4632801400	with flange A4632820445	1
300 GE/G300; 500GE/G5 (463.228)	(463) W463	125/170	1990/01-1994/12		TC00278-RI	A4632801400	with flange A4632820445	1
300 GE/G300 (463.207)	(463) W463	125/170	1990/01-1994/12		TC00278-RI	A4632801400	with flange A4632820445	1
G 300 (463.228, 463.227)	(463) W463	125/170	1993/06-1997/08		TC00278-RI	A4632801400		1
300 GE (463.227, 463.228)	(463) W463	128/174	1990/06-1997/08		TC00278-RI	A4632801400		1
G 300 TD (463.330, 463.331)	(463) W463	130/177	1996/08-2000/07		TC00022-RI	A4632801500		3
G 300 Turbo-D (463.331)	(463) W463	130/177	1996/08-2001/12		TC00022-RI	A4632801500		3
G 300 Turbo-D (463.308)	(463) W463	130/177	1996/08-2001/12		TC00022-RI	A4632801500		3
G 300 Turbo-D (463.330)	(463) W463	130/177	1996/08-2001/12		TC00022-RI	A4632801500		3
G 300 TD (463.308)	(463) W463	130/177	1996/09-2000/07		TC00022-RI	A4632801500		3
G 280 CDi 4-matic (461.346, 461.370)	(463) W463	135/184	2007/05-2012/12		TC00023-RI	A4632801700		2
320 GE (463.208)	(463) W463	155/211	1994/09-1997/11		TC00022-RI	A4632801500		3
G 320 (463.230, 463.231)	(463) W463	155/211	1994/09-1997/12		TC00022-RI	A4632801500		3
G 350 BlueTEC (463.346)	(463) W463	155/211	2011/07-		TC00023-RI	A4632801700		2
G 320 (463.250)	(463) W463	158/215	1994/09-2005/12		TC00023-RI	A4632801700		2
G 320 (463.244)	(463) W463	158/215	1994/09-2005/12		TC00023-RI	A4632801700		2
G 320 (463.232)	(463) W463	158/215	1994/09-2005/12		TC00022-RI	A4632801500		3

All rights reserved.

This publication may not be reproduced in any form, in whole or in part, without a written approval from S-TEC Service Technologies GmbH & Co OG.  
Subject to change without notice!

### Brand - Series - OEM Model

#### Maingroup - Subgroup

Salesname	Model	kW/HP	Model Year	Gearbox	Part Number	OEM Number	Info	Image
-----------	-------	-------	------------	---------	-------------	------------	------	-------

### Mercedes-Benz - G-Class - (463) W463

#### Gearbox, Powertrain - Transfer Case

G 320 (463.209)	(463) W463	158/215	1994/09-2005/12		TC00022-RI	A4632801500		3
G 320 (463.233)	(463) W463	158/215	1994/09-2005/12		TC00022-RI	A4632801500		3
G 320 (463.245)	(463) W463	158/215	1994/09-2005/12		TC00023-RI	A4632801700		2
G 320 (463.232, 463.233, 463.244, ...)	(463) W463	158/215	1997/07-2004/08		TC00022-RI	A4632801500		3
G 320 (463.232, 463.233, 463.244, ...)	(463) W463	158/215	1997/07-2004/08		TC00022-RI	A4632801500		3
G 320 (463.232, 463.233, 463.244, 463.245)	(463) W463	158/215	1997/07-2004/08		TC00023-RI	A4632801700		2
G 320 (463.209, 463.250)	(463) W463	158/215	1997/11-2004/08		TC00022-RI	A4632801500		3
G 320 CDI (463.343)	(463) W463	165/224	2006/09-2012/12		TC00023-RI	A4632801700		2
G 350 CDI (463.306, 463.340, 463.341, ...)	(463) W463	165/224	2009/06-2011/12		TC00023-RI	A4632801700		2
500 GE (463.228)	(463) W463	177/241	1993/09-1994/12		TC00278-RI	A4632801400		1
G 350 d (463.348)	(463) W463	180/245	2015/06-2018/04		TC00023-RI	A4632801700		2
G 400 CDI (463.333)	(463) W463	184/250	2000/12-2005/12		TC00023-RI	A4632801700		2
G 400 CDI (463.332)	(463) W463	184/250	2000/12-2005/12		TC00023-RI	A4632801700		2
G 400 CDI (463.309)	(463) W463	184/250	2000/12-2005/12		TC00023-RI	A4632801700		2
G 400 CDI (463.332, 463.333)	(463) W463	184/250	2000/12-2006/07		TC00023-RI	A4632801700		2
G 36 AMG (463.230)	(463) W463	200/272	1995/01-1998/07		TC00276-RI	A4632801000		1
G 320 / G36 AMG (463.208)	(463) W463	200/272	1995/01-1998/12		TC00022-RI	A4632801500		3
G 320 / G36 AMG (463.231)	(463) W463	200/272	1995/01-1998/12		TC00276-RI	A4632801000		1
G 320 / G36 AMG (463.208)	(463) W463	200/272	1995/01-1998/12		TC00276-RI	A4632801000		1
G 320 / G36 AMG (463.231)	(463) W463	200/272	1995/01-1998/12		TC00022-RI	A4632801500		3
G 320 / G36 AMG (463.230)	(463) W463	200/272	1995/01-1998/12		TC00276-RI	A4632801000		1
G 320 / G36 AMG (463.230)	(463) W463	200/272	1995/01-1998/12		TC00022-RI	A4632801500		3
G 500 (463.249)	(463) W463	215/292	2004/09-2005/12		TC00023-RI	A4632801700		2
G 500 (463.254)	(463) W463	218/296	1998/04-2007/12		TC00023-RI	A4632801700		2
G 500 (463.248)	(463) W463	218/296	1998/04-2007/12		TC00023-RI	A4632801700		2
G 500 (463.247)	(463) W463	218/296	1998/04-2007/12		TC00023-RI	A4632801700		2
G 500 (463.249)	(463) W463	218/296	1998/04-2007/12		TC00023-RI	A4632801700		2
G 500 (463.247, 463.248, 463.249, ...)	(463) W463	218/296	1998/04-2015/12		TC00022-RI	A4632801500		3
G 500 (463.247, 463.248, 463.249, ...)	(463) W463	218/296	1998/04-2015/12		TC00023-RI	A4632801700		2
G 500 / G 55 AMG (463.241)	(463) W463	260/354	1999/04-2004/05		TC00022-RI	A4632801500		3
G 500 / G 55 AMG (463.240)	(463) W463	260/354	1999/04-2004/05		TC00022-RI	A4632801500		3
G 55 AMG (463.246)	(463) W463	260/354	1999/04-2004/05		TC00023-RI	A4632801700		2
G 500 / G 55 AMG (463.206)	(463) W463	260/354	1999/04-2004/05		TC00022-RI	A4632801500		3

All rights reserved.

This publication may not be reproduced in any form, in whole or in part, without a written approval from S-TEC Service Technologies GmbH & Co OG.  
Subject to change without notice!

### Brand - Series - OEM Model

#### Maingroup - Subgroup

Salesname	Model	kW/HP	Model Year	Gearbox	Part Number	OEM Number	Info	Image
-----------	-------	-------	------------	---------	-------------	------------	------	-------

### Mercedes-Benz - G-Class - (463) W463

#### Gearbox, Powertrain - Transfer Case

G 55 AMG (463.243)	(463) W463	260/354	1999/04-2004/05		TC00023-RI	A4632801700		2
G 55 AMG (463.243, 463.246)	(463) W463	260/354	1999/04-2008/07		TC00023-RI	A4632801700		2
G 500 (463.236)	(463) W463	285/388	2008/01-		TC00019-RI	A4602803600		4
G 500 (463.236)	(463) W463	285/388	2008/01-		TC00023-RI	A4632801700		2
G 500 (463.222, 463.236, 463.237, ...)	(463) W463	285/388	2008/05-2015/08		TC00023-RI	A4632801700		2
G 500 (463.234, 463.239)	(463) W463	310/422	2015/06-2018/04		TC00023-RI	A4632801700		2
G 55 AMG (463.270)	(463) W463	350/476	2004/06-2006/07		TC00023-RI	A4632801700		2
G 55 AMG (463.270, 463.271)	(463) W463	350/476	2004/06-2011/12		TC00023-RI	A4632801700		2
G 55 AMG (463.270, 463.271)	(463) W463	368/500	2006/08-2012/12		TC00023-RI	A4632801700		2
G 55 AMG (463.270, 463.271)	(463) W463	373/507	2008/08-2012/06		TC00023-RI	A4632801700		2
G 63 AMG (463.273)	(463) W463	400/544	2012/05-2018/03		TC00023-RI	A4632801700		2
G 63 AMG (463.272)	(463) W463	400/544	2012/06-		TC00022-RI	A4632801500		3
AMG G 63 (463.272)	(463) W463	420/571	2015/06-2018/03		TC00023-RI	A4632801700		2
G 65 AMG (463.274)	(463) W463	450/612	2012/06-		TC00022-RI	A4632801500		3
AMG G 65 (463.274, 463.275)	(463) W463	463/630	2015/06-2018/04		TC00023-RI	A4632801700		2
250 GD (463.304)	(463) W463	69/94	1990/01-1992/12		TC00278-RI	A4632801400	with flange A4632820445	1
250 GD (463.325)	(463) W463	69/94	1990/01-1992/12		TC00278-RI	A4632801400	with flange A4632820445	1
250 GD (463.324)	(463) W463	69/94	1990/01-1992/12		TC00278-RI	A4632801400	with flange A4632820445	1
250 GD (463.324, 463.325)	(463) W463	69/94	1990/06-1992/10		TC00278-RI	A4632801400		1
200 GE (463.200)	(463) W463	80/109	1990/01-1993/07		TC00277-RI	A4632801100		1
300 GD (463.327, 463.328)	(463) W463	83/113	1989/09-1993/08		TC00277-RI	A4632801100		1
300 GD (463.327, 463.328)	(463) W463	83/113	1989/09-1993/08		TC00278-RI	A4632801400		1
300 GD (463.307)	(463) W463	83/113	1989/09-1993/08		TC00277-RI	A4632801100		1
300 GD/G 300 Diesel (463.307)	(463) W463	83/113	1990/01-1994/12		TC00278-RI	A4632801400	with flange A4632820445	1
300 GD/G300 Diesel (463.328)	(463) W463	83/113	1990/01-1994/12		TC00278-RI	A4632801400	with flange A4632820445	1
300 GD/G300 Diesel (463.327)	(463) W463	83/113	1990/01-1994/12		TC00278-RI	A4632801400	with flange A4632820445	1
300 GD/G 300 Diesel (463.307)	(463) W463	83/113	1990/01-1994/12		TC00277-RI	A4632801100	with flange A4632820145	1
300 GD/G300 Diesel (463.327)	(463) W463	83/113	1990/01-1994/12		TC00277-RI	A4632801100	with flange A4632820145	1
300 GD/G300 Diesel (463.328)	(463) W463	83/113	1990/01-1994/12		TC00277-RI	A4632801100	with flange A4632820145	1
G 300 Diesel (463.327, 463.328)	(463) W463	83/113	1993/09-1994/08		TC00278-RI	A4632801400		1
G 300 Diesel (463.307)	(463) W463	83/113	1993/09-1994/08		TC00277-RI	A4632801100		1

All rights reserved.

This publication may not be reproduced in any form, in whole or in part, without a written approval from S-TEC Service Technologies GmbH & Co OG. Subject to change without notice!

Brand - Series - OEM Model								
Maingroup - Subgroup								
Salesname	Model	kW/HP	Model Year	Gearbox	Part Number	OEM Number	Info	Image

Mercedes-Benz - G-Class - (463) W463								
Gearbox, Powertrain - Transfer Case								
G 300 Diesel (463.327, 463.328)	(463) W463	83/113	1993/09-1994/08		TC00277-RI	A4632801100		1
200 GE (463.220)	(463) W463	85/116	1990/01-1993/07		TC00277-RI	A4632801100		1
200 GE (463.220)	(463) W463	85/116	1990/01-1993/07		TC00278-RI	A4632801400		1
200 GE (463.200)	(463) W463	85/116	1990/01-1993/07		TC00277-RI	A4632801100		1
200 GE (463.220)	(463) W463	85/116	1990/01-1993/12		TC00277-RI	A4632801100	with flange A4632820145	1
200 GE (463.200)	(463) W463	85/116	1990/01-1993/12		TC00278-RI	A4632801400	with flange A4632820445	1
200 GE (463.200)	(463) W463	85/116	1990/01-1993/12		TC00277-RI	A4632801100	with flange A4632820145	1
200 GE (463.221)	(463) W463	85/116	1990/01-1993/12		TC00278-RI	A4632801400	with flange A4632820445	1
200 GE (463.221)	(463) W463	85/116	1990/01-1993/12		TC00277-RI	A4632801100	with flange A4632820145	1
200 GE (463.220)	(463) W463	85/116	1990/01-1993/12		TC00278-RI	A4632801400	with flange A4632820445	1
230 GE/G230 (463.224)	(463) W463	93/126	1990/01-1995/12		TC00277-RI	A4632801100	with flange A4632820145	1
230 GE/G230 (463.204)	(463) W463	93/126	1990/01-1995/12		TC00277-RI	A4632801100	with flange A4632820145	1
230 GE/G230 (463.225)	(463) W463	93/126	1990/01-1995/12		TC00278-RI	A4632801400	with flange A4632820445	1
230 GE/G230 (463.204)	(463) W463	93/126	1990/01-1995/12		TC00278-RI	A4632801400	with flange A4632820445	1
230 GE/G230 (463.225)	(463) W463	93/126	1990/01-1995/12		TC00277-RI	A4632801100	with flange A4632820145	1
230 GE/G230 (463.224)	(463) W463	93/126	1990/01-1995/12		TC00278-RI	A4632801400	with flange A4632820445	1
230 GE (463.204)	(463) W463	93/126	1990/06-1993/02		TC00277-RI	A4632801100		1
230 GE (463.224, 463.225)	(463) W463	93/126	1990/06-1993/06		TC00278-RI	A4632801400		1
230 GE (463.224, 463.225)	(463) W463	93/126	1990/06-1993/06		TC00277-RI	A4632801100		1

All rights reserved.

This publication may not be reproduced in any form, in whole or in part, without a written approval from S-TEC Service Technologies GmbH & Co OG.  
Subject to change without notice!



### Brand - Series - OEM Model

### Maingroup - Subgroup

Salesname	Model	kW/HP	Model Year	Gearbox	Part Number	OEM Number	Info	Image
-----------	-------	-------	------------	---------	-------------	------------	------	-------

### Mercedes-Benz - GL-Class - (164) X164



Img.1



Img.2

### Gearbox, Powertrain - Transfer Case

GL 320 CDI / 350 BlueTEC 4-matic (164.824, 164.825)	(164) X164	155/211	2009/12-2011/07		TC00280-RI	A1662800800	with reduction	1
GL 320 CDI / 350 BlueTEC 4-matic (164.824, 164.825)	(164) X164	155/211	2009/12-2014/01		TC00274-RI	A2512802700; A2512803100; A2512803500		
GL 320 CDI 4-matic (164.822)	(164) X164	165/224	2006/09-2009/05		TC00280-RI	A1662800800	with reduction	1
GL 320 CDI 4-matic (164.822)	(164) X164	165/224	2006/09-2009/05		TC00274-RI	A2512802700; A2512803100; A2512803500		
GL 350 CDI 4-matic (164.822)	(164) X164	165/224	2009/05-2009/12		TC00280-RI	A1662800800	with reduction	1
GL 350 CDI 4-matic (164.822)	(164) X164	165/224	2009/05-2014/01		TC00274-RI	A2512802700; A2512803100; A2512803500		
GL 350 CDI 4-matic (164.823)	(164) X164	195/265	2010/01-		TC00280-RI	A1662800800	with reduction	1
GL 350 CDI 4-matic (164.823)	(164) X164	195/265	2010/01-		TC00274-RI	A2512802700; A2512803100; A2512803500		
GL 420 CDI 4-matic (164.828)	(164) X164	225/306	2006/09-2008/10		TC00269-RI	A1642801200	with reduction	1
GL 420 CDI 4-matic (164.828)	(164) X164	225/306	2006/09-2008/10		TC00268-RI	A2512801300		2
GL 420 CDI 4-matic (164.828)	(164) X164	225/306	2008/10-		TC00274-RI	A2512802700; A2512803100; A2512803500		
GL 420 CDI 4-matic (164.828)	(164) X164	225/306	2008/10-		TC00280-RI	A1662800800	with reduction	1
GL 450 CDI 4-matic (164.828)	(164) X164	225/306	2009/05-		TC00280-RI	A1662800800	with reduction	1
GL 450 CDI 4-matic (164.828)	(164) X164	225/306	2009/05-		TC00274-RI	A2512802700; A2512803100; A2512803500		
GL 450 4-matic (164.871)	(164) X164	250/340	2006/09-2014/01		TC00274-RI	A2512802700; A2512803100; A2512803500		
GL 450 4-matic (164.871)	(164) X164	250/340	2006/09-		TC00280-RI	A1662800800	with reduction	1
GL 500 4-matic (164.886)	(164) X164	285/388	2007/10-		TC00280-RI	A1662800800	with reduction	1
GL 500 4-matic (164.886)	(164) X164	285/388	2009/09-2010/07		TC00274-RI	A2512802700; A2512803100; A2512803500		

All rights reserved.

This publication may not be reproduced in any form, in whole or in part, without a written approval from S-TEC Service Technologies GmbH & Co OG.  
Subject to change without notice!

### Brand - Series - OEM Model

### Maingroup - Subgroup

Salesname	Model	kW/HP	Model Year	Gearbox	Part Number	OEM Number	Info	Image
-----------	-------	-------	------------	---------	-------------	------------	------	-------

### Mercedes-Benz - GL-Class - (166) X166



Img.1



Img.2



Img.3

### Gearbox, Powertrain - Transfer Case

GL 350 CDI / BlueTEC 4-matic (166.824)	(166) X166	179/243	2012/07-		TC00537-RI	A2512802800		1
GL 350 CDI / BlueTEC 4-matic (166.824)	(166) X166	179/243	2012/07-		TC00280-RI	A1662800800	with reduction	2
GL 350 CDI / BlueTec 4-matic (166.823, 166.824)	(166) X166	190/258	2012/07-		TC00537-RI	A2512802800		1
GL 350 CDI / BlueTec 4-matic (166.823, 166.824)	(166) X166	190/258	2012/07-		TC00280-RI	A1662800800	with reduction	2
GL 400 4-matic (166.856)	(166) X166	245/333	2013/08-		TC00280-RI	A1662800800	with reduction	2
GL 400 4-matic (166.856)	(166) X166	245/333	2014/01-		TC00274-RI	A2512802700; A2512803100; A2512803500		
GL 450 4-matic (166.872)	(166) X166	270/367	2012/07-		TC00280-RI	A1662800800	with reduction	2
GL 450 4-matic (166.872)	(166) X166	270/367	2014/01-		TC00274-RI	A2512802700; A2512803100; A2512803500		
GL 500 4-matic (166.871)	(166) X166	310/422	2015/04-		TC00274-RI	A2512802700; A2512803100; A2512803500		
GL 500 4-matic (166.871)	(166) X166	310/422	2015/04-		TC00280-RI	A1662800800	with reduction	2
GL 500 4-matic (166.873)	(166) X166	320/435	2012/07-		TC00280-RI	A1662800800	with reduction	2
GL 500 4-matic (166.873, 166.874)	(166) X166	320/435	2014/01-		TC00274-RI	A2512802700; A2512803100; A2512803500		
GL 63 AMG 4-matic (166.874)	(166) X166	400/544	2012/07-2015/06		TC00527-RI	A2512803200		3
GL 63 AMG 4-matic	(166) X166	405/551	2012/07-2015/06		TC00527-RI	A2512803200		3
GL 63 AMG 4-matic (166.874)	(166) X166	410/558	2012/07-2015/06		TC00527-RI	A2512803200		3

### Mercedes-Benz - GL-Class - GL 450 4-matic

### Gearbox, Powertrain - Transfer Case

(166) X166	GL 450 4-matic	270/367	2014/09-2015/10		TC00274-RI	A2512802700; A2512803100; A2512803500		
------------	----------------	---------	-----------------	--	------------	---	--	--

All rights reserved.

This publication may not be reproduced in any form, in whole or in part, without a written approval from S-TEC Service Technologies GmbH & Co OG.  
Subject to change without notice!

### Brand - Series - OEM Model

### Maingroup - Subgroup

Salesname	Model	kW/HP	Model Year	Gearbox	Part Number	OEM Number	Info	Image
-----------	-------	-------	------------	---------	-------------	------------	------	-------

### Mercedes-Benz - GLA-Class - (156) X156



Img.1

### Rear Axle - Rear Differential

GLA 200 CDI 4-matic (156.902)	(156) X156	100/136	2013/12-		RD00098-RI	A1763503100		1
GLA 220 CDI / d 4-matic (156.905)	(156) X156	120/163	2013/12-		RD00098-RI	A1763503100		1
GLA 220 CDI 4-matic (156.905)	(156) X156	125/170	2013/12-		RD00098-RI	A1763503100		1
GLA 220 d 4-matic (156.905)	(156) X156	130/177	2015/07-		RD00098-RI	A1763503100		1
GLA 220 4-matic (156.947)	(156) X156	135/184	2015/04-		RD00098-RI	A1763503100		1
GLA 250 4-matic (156.946)	(156) X156	155/211	2013/12-		RD00098-RI	A1763503100		1
GLA 45 AMG 4-matic (156.952)	(156) X156	265/360	2014/05-		RD00098-RI	A1763503100		1
GLA 45 4-matic (156.952)	(156) X156	280/381	2015/07-		RD00098-RI	A1763503100		1

All rights reserved.

This publication may not be reproduced in any form, in whole or in part, without a written approval from S-TEC Service Technologies GmbH & Co OG.  
Subject to change without notice!

### Brand - Series - OEM Model

### Maingroup - Subgroup

Salesname	Model	kW/HP	Model Year	Gearbox	Part Number	OEM Number	Info	Image
-----------	-------	-------	------------	---------	-------------	------------	------	-------

### Mercedes-Benz - GLE-Class - (166) W166



Img.1



Img.2



Img.3

### Gearbox, Powertrain - Transfer Case

GLE 250 d 4-matic (166.004)	(166) W166	150/204	2015/04-		TC00280-RI	A1662800800	with reduction	1
GLE 250 d 4-matic (166.004)	(166) W166	150/204	2015/04-		TC00537-RI	A2512802800		2
350 d 4-matic (166.024)	(166) W166	183/249	2015/04-2018/10		TC00274-RI	A2512802700; A2512803100; A2512803500		
GLE 350 d 4-matic (166.024)	(166) W166	190/258	2015/04-		TC00280-RI	A1662800800	with reduction	1
GLE 350 d 4-matic (166.024)	(166) W166	190/258	2015/04-		TC00537-RI	A2512802800		2
GLE 320 4-matic (166.062)	(166) W166	200/272	2015/10-		TC00280-RI	A1662800800	with reduction	1
GLE 320 4-matic (166.062)	(166) W166	200/272	2015/10-		TC00274-RI	A2512802700; A2512803100; A2512803500		
GLE 350 4-matic (166.057)	(166) W166	225/306	2015/11-		TC00280-RI	A1662800800	with reduction	1
GLE 350 4-matic (166.057)	(166) W166	225/306	2015/11-		TC00274-RI	A2512802700; A2512803100; A2512803500		
GLE 400 4-matic (166.056)	(166) W166	245/333	2015/04-		TC00280-RI	A1662800800	with reduction	1
GLE 400 4-matic (166.056)	(166) W166	245/333	2015/04-		TC00274-RI	A2512802700; A2512803100; A2512803500		
GLE 450 AMG 4-matic (166.064)	(166) W166	270/367	2015/10-2016/04		TC00274-RI	A2512802700; A2512803100; A2512803500		
GLE 450 AMG 4-matic (166.064)	(166) W166	270/367	2015/10-2016/04		TC00280-RI	A1662800800	with reduction	1
GLE 43 4-matic (166.064)	(166) W166	270/367	2016/05-		TC00274-RI	A2512802700; A2512803100; A2512803500		
GLE 500 4-matic (166.073)	(166) W166	300/408	2015/04-		TC00280-RI	A1662800800	with reduction	1
GLE 500 4-matic (166.073)	(166) W166	300/408	2015/04-		TC00274-RI	A2512802700; A2512803100; A2512803500		
GLE 500 4-matic (166.073)	(166) W166	320/435	2015/04-		TC00274-RI	A2512802700; A2512803100; A2512803500		
GLE 500 4-matic (166.073)	(166) W166	335/456	2015/10-		TC00280-RI	A1662800800	with reduction	1
GLE 63 4-matic (166.074)	(166) W166	386/525	2015/04-2017/05		TC00527-RI	A2512803200		3
GLE 63 4-matic (166.074)	(166) W166	410/557	2015/04-		TC00527-RI	A2512803200		3
GLE 63 S 4-matic (166.075)	(166) W166	430/585	2014/01-2015/06		TC00527-RI	A2512803200		3

All rights reserved.

This publication may not be reproduced in any form, in whole or in part, without a written approval from S-TEC Service Technologies GmbH & Co OG.  
Subject to change without notice!

## Brand - Series - OEM Model

### Maingroup - Subgroup

Salesname	Model	kW/HP	Model Year	Gearbox	Part Number	OEM Number	Info	Image
-----------	-------	-------	------------	---------	-------------	------------	------	-------

## Mercedes-Benz - GLE-Class - (292) C292



Img.1

### Gearbox, Powertrain - Transfer Case

GLE 63 4-matic (292.374)	(292) C292	410/557	2015/03-		TC00527-RI	A2512803200		1
GLE 63 S 4-matic (292.375)	(292) C292	430/585	2015/03-		TC00527-RI	A2512803200		1

## Mercedes-Benz - GLE-Class - (292)C292

### Gearbox, Powertrain - Transfer Case

GLE 320 4-matic (292.362)	(292)C292	200/272	2015/09-		TC00274-RI	A2512802700; A2512803100; A2512803500		
GLE 400 4-matic (292.356)	(292)C292	245/333	2015/03-		TC00274-RI	A2512802700; A2512803100; A2512803500		

## Mercedes-Benz - GLS-Class - (166) X166



Img.1



Img.2



Img.3

### Gearbox, Powertrain - Transfer Case

GLS 350 d 4-matic (166.824)	(166) X166	190/258	2015/11-		TC00280-RI	A1662800800	with reduction	1
GLS 350 d 4-matic (166.824)	(166) X166	190/258	2015/11-		TC00537-RI	A2512802800		2
GLS 400 4-matic (166.856)	(166) X166	245/333	2015/11-		TC00274-RI	A2512802700; A2512803100; A2512803500		
GLS 400 4-matic (166.856)	(166) X166	245/333	2015/11-		TC00280-RI	A1662800800	with reduction	1
GLS 450 4-matic (166.864)	(166) X166	270/367	2016/06-		TC00280-RI	A1662800800	with reduction	1
GLS 450 4-matic (166.864)	(166) X166	270/367	2016/06-		TC00274-RI	A2512802700; A2512803100; A2512803500		
GLS 500 4-matic (166.871)	(166) X166	310/422	2016/03-		TC00274-RI	A2512802700; A2512803100; A2512803500		
GLS 500 4-matic (166.871)	(166) X166	310/422	2016/03-		TC00280-RI	A1662800800	with reduction	1
GLS 500 4-matic (166.873)	(166) X166	335/456	2015/11-		TC00280-RI	A1662800800	with reduction	1
GLS 500 4-matic (166.873)	(166) X166	335/456	2015/11-		TC00274-RI	A2512802700; A2512803100; A2512803500		
GLS 63 4-matic (166.875, 166.874)	(166) X166	430/585	2015/11-		TC00527-RI	A2512803200		3

All rights reserved.

This publication may not be reproduced in any form, in whole or in part, without a written approval from S-TEC Service Technologies GmbH & Co OG.  
Subject to change without notice!

### Brand - Series - OEM Model

### Maingroup - Subgroup

Salesname	Model	kW/HP	Model Year	Gearbox	Part Number	OEM Number	Info	Image
-----------	-------	-------	------------	---------	-------------	------------	------	-------

### Mercedes-Benz - M-Class - (164) W164



Img.1



Img.2



Img.3

### Gearbox, Powertrain - Transfer Case

M 280 CDI 4-matic (164.120)	(164) W164	140/190	2005/07-2009/07		TC00274-RI	A2512802700; A2512803100; A2512803500		
M 280 CDI 4-matic (164.120)	(164) W164	140/190	2005/07-2009/07		TC00280-RI	A1662800800	with reduction	1
M 300 CDI 4-matic (164.120)	(164) W164	140/190	2009/07-2011/12		TC00280-RI	A1662800800	with reduction	1
M 300 CDI 4-matic (164.120)	(164) W164	140/190	2009/07-2011/12		TC00274-RI	A2512802700; A2512803100; A2512803500		
M 300 CDI 4-matic (164.121)	(164) W164	150/204	2010/02-2011/12		TC00280-RI	A1662800800	with reduction	1
M 300 CDI 4-matic (164.121)	(164) W164	150/204	2010/02-2011/12		TC00274-RI	A2512802700; A2512803100; A2512803500		
M 320 CDI 4-matic (164.122)	(164) W164	155/211	2005/07-2011/07		TC00274-RI	A2512802700; A2512803100; A2512803500		
M 350 CDI 4-matic (164.125)	(164) W164	155/211	2009/09-2011/12		TC00280-RI	A1662800800	with reduction	1
M 350 Blutec 4-matic (164.124)	(164) W164	155/211	2009/09-2011/12		TC00274-RI	A2512802700; A2512803100; A2512803500		
M 350 Blutec 4-matic (164.124)	(164) W164	155/211	2009/09-2011/12		TC00280-RI	A1662800800	with reduction	1
M 350 CDI 4-matic (164.125)	(164) W164	155/211	2009/09-2011/12		TC00274-RI	A2512802700; A2512803100; A2512803500		
M 320 CDI 4-matic (164.122)	(164) W164	165/224	2005/07-2009/07		TC00280-RI	A1662800800	with reduction	1
M 320 CDI 4-matic (164.122)	(164) W164	165/224	2005/07-2009/07		TC00274-RI	A2512802700; A2512803100; A2512803500		
M 350 CDI 4-matic (164.122)	(164) W164	165/224	2009/07-2011/12		TC00274-RI	A2512802700; A2512803100; A2512803500		
M 350 CDI 4-matic (164.122)	(164) W164	165/224	2009/07-2011/12		TC00280-RI	A1662800800	with reduction	1
M 350 CDI 4-matic (164.125)	(164) W164	170/231	2010/02-2011/12		TC00274-RI	A2512802700; A2512803100; A2512803500		
M 350 CDI 4-matic (164.125)	(164) W164	170/231	2010/02-2011/12		TC00280-RI	A1662800800	with reduction	1
M 300 4-matic (164.182)	(164) W164	170/231	2010/03-2014/01		TC00274-RI	A2512802700; A2512803100; A2512803500		
M 300 4-matic (164.182)	(164) W164	170/231	2010/03-		TC00280-RI	A1662800800	with reduction	1
M 350 4-matic (164.186)	(164) W164	200/272	2005/07-2011/12		TC00274-RI	A2512802700; A2512803100; A2512803500		
M 350 4-matic (164.186)	(164) W164	200/272	2005/07-2011/12		TC00280-RI	A1662800800	with reduction	1
M 450 Hybrid 4-matic (164.195)	(164) W164	200/272	2009/09-2011/12		TC00283-RI	A2512801700		2

All rights reserved.

This publication may not be reproduced in any form, in whole or in part, without a written approval from S-TEC Service Technologies GmbH & Co OG.  
Subject to change without notice!

### Brand - Series - OEM Model

### Maingroup - Subgroup

Salesname	Model	kW/HP	Model Year	Gearbox	Part Number	OEM Number	Info	Image
-----------	-------	-------	------------	---------	-------------	------------	------	-------

### Mercedes-Benz - M-Class - (164) W164

### Gearbox, Powertrain - Transfer Case

M 500 4-matic (164.175)	(164) W164	218/296	2005/09-2006/12		TC00280-RI	A1662800800	with reduction	1
M 500 4-matic (164.175)	(164) W164	218/296	2005/09-2006/12		TC00274-RI	A2512802700; A2512803100; A2512803500		
M 500 4-matic (164.175)	(164) W164	225/306	2005/07-2011/12		TC00280-RI	A1662800800	with reduction	1
M 500 4-matic (164.175)	(164) W164	225/306	2005/07-2011/12		TC00274-RI	A2512802700; A2512803100; A2512803500		
M 420 CDI 4-matic (164.128)	(164) W164	225/306	2006/02-2008/10		TC00269-RI	A1642801200	with reduction	1
M 420 CDI 4-matic (164.128)	(164) W164	225/306	2006/02-2008/10		TC00268-RI	A2512801300		2
M 420 CDI 4-matic (164.128)	(164) W164	225/306	2008/10-2011/12		TC00274-RI	A2512802700; A2512803100; A2512803500		
M 420 CDI 4-matic (164.128)	(164) W164	225/306	2008/10-2011/12		TC00280-RI	A1662800800	with reduction	1
M 450 CDI 4-matic (164.128)	(164) W164	225/306	2009/09-2011/12		TC00280-RI	A1662800800	with reduction	1
M 450 CDI 4-matic (164.128)	(164) W164	225/306	2009/09-2011/12		TC00274-RI	A2512802700; A2512803100; A2512803500		
M 500 4-matic (164.172)	(164) W164	285/388	2007/12-2011/12		TC00274-RI	A2512802700; A2512803100; A2512803500		
M 500 4-matic (164.172)	(164) W164	285/388	2007/12-2011/12		TC00280-RI	A1662800800	with reduction	1
M 63 AMG 4-matic (164.177)	(164) W164	375/510	2006/01-2011/12		TC00282-RI	A2512801400		3

All rights reserved.

This publication may not be reproduced in any form, in whole or in part, without a written approval from S-TEC Service Technologies GmbH & Co OG.  
Subject to change without notice!

### Brand - Series - OEM Model

### Maingroup - Subgroup

Salesname	Model	kW/HP	Model Year	Gearbox	Part Number	OEM Number	Info	Image
-----------	-------	-------	------------	---------	-------------	------------	------	-------

### Mercedes-Benz - M-Class - (166) W166



Img.1



Img.2



Img.3

### Gearbox, Powertrain - Transfer Case

M 250 CDI / BlueTEC 4-matic (166.004, 166.003)	(166) W166	150/204	2011/06-		TC00537-RI	A2512802800		1
M 250 CDI / BlueTEC 4-matic (166.004, 166.003)	(166) W166	150/204	2011/09-		TC00280-RI	A1662800800	with reduction	2
M 350 CDI 4-matic (166.023)	(166) W166	170/231	2011/06-		TC00537-RI	A2512802800		1
M 350 CDI 4-matic (166.023)	(166) W166	170/231	2011/09-		TC00280-RI	A1662800800	with reduction	2
M 300 4-matic (166.055)	(166) W166	185/252	2014/04-		TC00274-RI	A2512802700; A2512803100; A2512803500		
M 300 4-matic (166.055)	(166) W166	185/252	2014/04-		TC00280-RI	A1662800800	with reduction	2
M 350 BlueTEC 4-matic (166.024)	(166) W166	190/258	2011/06-		TC00537-RI	A2512802800		1
M 350 BlueTEC 4-matic (166.024)	(166) W166	190/258	2011/09-		TC00280-RI	A1662800800	with reduction	2
M 320 4-matic (166.062)	(166) W166	200/272	2013/11-		TC00280-RI	A1662800800	with reduction	2
M 320 4-matic (166.062)	(166) W166	200/272	2014/01-		TC00274-RI	A2512802700; A2512803100; A2512803500		
M 350 (166.058)	(166) W166	225/306	2011/09-		TC00280-RI	A1662800800	with reduction	2
M 350 4-matic (166.057)	(166) W166	225/306	2011/09-		TC00280-RI	A1662800800	with reduction	2
M 350 4-matic (166.057)	(166) W166	225/306	2014/01-		TC00274-RI	A2512802700; A2512803100; A2512803500		
M 400 4-matic (166.056)	(166) W166	245/333	2013/08-		TC00280-RI	A1662800800	with reduction	2
M 400 4-matic (166.056)	(166) W166	245/333	2014/01-		TC00274-RI	A2512802700; A2512803100; A2512803500		
M 500 4-matic (166.073)	(166) W166	300/408	2012/02-		TC00280-RI	A1662800800	with reduction	2
M 500 4-matic (166.073)	(166) W166	300/408	2014/01-		TC00274-RI	A2512802700; A2512803100; A2512803500		
M 63 AMG 4-matic (166.074)	(166) W166	386/525	2011/11-		TC00527-RI	A2512803200		3
M 63 AMG 4-matic (166.074)	(166) W166	410/558	2011/11-		TC00527-RI	A2512803200		3

All rights reserved.

This publication may not be reproduced in any form, in whole or in part, without a written approval from S-TEC Service Technologies GmbH & Co OG.  
Subject to change without notice!



## Brand - Series - OEM Model

### Maingroup - Subgroup

Salesname	Model	kW/HP	Model Year	Gearbox	Part Number	OEM Number	Info	Image
-----------	-------	-------	------------	---------	-------------	------------	------	-------

## Mercedes-Benz - R-Class - (251) W251, V251



Img.1



Img.2

### Gearbox, Powertrain - Transfer Case

R 300 CDI 4-matic (251.020)	(251) W251, V251	140/190	2009/10-		TC00274-RI	A2512802700; A2512803100; A2512803500		
R 280 CDI 4-matic (251.020)	(251) W251, V251	140/190	2009/10-		TC00274-RI	A2512802700; A2512803100; A2512803500		
R 320 CDI 4-matic (251.125)	(251) W251, V251	155/211	2009/10-		TC00274-RI	A2512802700; A2512803100; A2512803500		
R 350 CDI 4-matic (251.124, 251.125)	(251) W251, V251	155/211	2009/10-		TC00274-RI	A2512802700; A2512803100; A2512803500		
R 350 CDI 4-matic (251.022, 251.122)	(251) W251, V251	165/224	2009/10-		TC00274-RI	A2512802700; A2512803100; A2512803500		
R 320 CDI 4-matic (251.022, 251.122)	(251) W251, V251	165/224	2009/10-		TC00274-RI	A2512802700; A2512803100; A2512803500		
R 350 CDI 4-matic (251.023, 251.123)	(251) W251, V251	195/265	2010/08-		TC00274-RI	A2512802700; A2512803100; A2512803500		
R 350 4-matic (251.065, 251.165)	(251) W251, V251	200/272	2006/01-2010/07		TC00269-RI	A1642801200	with reduction	1
R 350 4-matic (251.065, 251.165)	(251) W251, V251	200/272	2009/10-		TC00274-RI	A2512802700; A2512803100; A2512803500		
R 320 4-matic (251.163)	(251) W251, V251	200/272	2014/01-		TC00274-RI	A2512802700; A2512803100; A2512803500		
R 500 4-matic (251.075, 251.175)	(251) W251, V251	225/306	2009/10-		TC00274-RI	A2512802700; A2512803100; A2512803500		
R 350 CGI 4-matic (251.057, 251.157)	(251) W251, V251	225/306	2009/10-		TC00274-RI	A2512802700; A2512803100; A2512803500		
R 400 4-matic (251.166)	(251) W251, V251	245/333	2014/01-		TC00274-RI	A2512802700; A2512803100; A2512803500		
R 500 4-matic (251.072, 251.172)	(251) W251, V251	285/388	2009/10-		TC00274-RI	A2512802700; A2512803100; A2512803500		
R 63 AMG 4-matic (251.077, 251.177)	(251) W251, V251	375/510	2006/02-		TC00282-RI	A2512801400		2

## Mercedes-Benz - R-Class - (251) W251,V251

### Gearbox, Powertrain - Transfer Case

R 280 4-matic (251.062)	(251) W251,V251	170/231	2009/10-		TC00274-RI	A2512802700; A2512803100; A2512803500		
----------------------------	--------------------	---------	----------	--	------------	---	--	--

All rights reserved.

This publication may not be reproduced in any form, in whole or in part, without a written approval from S-TEC Service Technologies GmbH & Co OG.  
Subject to change without notice!

### Brand - Series - OEM Model

### Maingroup - Subgroup

Salesname	Model	kW/HP	Model Year	Gearbox	Part Number	OEM Number	Info	Image
-----------	-------	-------	------------	---------	-------------	------------	------	-------

### Mercedes-Benz - S-Class - (220) W220



Img.1

### Gearbox, Powertrain - Transfer Case

S 350 4-matic (220.087, 220.187)	(220) W220	180/245	2003/06-2005/08		TC00185-RI	A2202800700		1
S 430 4-matic (220.083, 220.183)	(220) W220	205/279	2002/09-2005/08		TC00185-RI	A2202800700		1
S 500 4-matic (220.084, 220.184)	(220) W220	225/306	2002/09-2005/08		TC00185-RI	A2202800700		1

All rights reserved.

This publication may not be reproduced in any form, in whole or in part, without a written approval from S-TEC Service Technologies GmbH & Co OG.  
Subject to change without notice!

## Brand - Series - Sales Name

### Maingroup - Subgroup

Salesname	Model	kW/HP	Model Year	Gearbox	Part Number	OEM Number	Info	Image
-----------	-------	-------	------------	---------	-------------	------------	------	-------

## Nissan - Armada - ARMADA



Img.1

### Gearbox, Powertrain - Transfer Case

ARMADA	5.6 4x4	236/321	2006/09-2015/12	7AT	TC00271-RI	331001LA0E		1
ARMADA	5.6 4x4	291/396	2016/05-	7AT	TC00271-RI	331001LA0E		1

## Nissan - Pathfinder - PATHFINDER (R51)



Img.1

### Gearbox, Powertrain - Transfer Case

PATHFINDER (R51)	3.0 TD V6	170/231	2010/05-	7A	TC00271-RI	331001LA0E		1
PATHFINDER (R51)	3.0 dCi	170/231	2010/08-	6MT	TC00271-RI	331001LA0E		1

## Nissan - Patrol - PATROL (Y62)



Img.1

### Gearbox, Powertrain - Transfer Case

PATROL (Y62)	5.6 NISMO	315/428	2016/10-	7AT	TC00271-RI	331001LA0E		1
PATROL (Y62)	5.6 V8	294/400	2010/03-	7A	TC00271-RI	331001LA0E		1
PATROL (Y62)	5.6	233/317	2010/04-	7AT	TC00272-RI	331001LU0C		1
PATROL (Y62)	5.6	233/317	2010/04-	7AT	TC00271-RI	331001LA0E		1
PATROL (Y62)	5.6	293/398	2010/12-	7AT	TC00271-RI	331001LA0E		1
PATROL (Y62)	5.6	298/405	2010/04-	7AT	TC00271-RI	331001LA0E		1

All rights reserved.

This publication may not be reproduced in any form, in whole or in part, without a written approval from S-TEC Service Technologies GmbH & Co OG.  
Subject to change without notice!

## Brand - Series - Sales Name

### Maingroup - Subgroup

Salesname	Model	kW/HP	Model Year	Gearbox	Part Number	OEM Number	Info	Image
-----------	-------	-------	------------	---------	-------------	------------	------	-------

## Porsche - Cayenne - CAYENNE (92A)



Img.1



Img.2



Img.3



Img.4



Img.5



Img.6



Img.7



Img.8

### Gearbox, Powertrain - Transfer Case

CAYENNE (92A)	3.0 Diesel	155/211	2010/06-	8DCT	TC00311-RI	0BU341011Q; 95834102003	Neck length: 127,4 ; with differential lock	1
CAYENNE (92A)	3.0 Diesel	176/239	2010/06-	8DCT	TC00311-RI	0BU341011Q; 95834102003	Neck length: 127,4 ; with differential lock	1
CAYENNE (92A)	3.0 Diesel	180/245	2011/06-	8DCT	TC00311-RI	0BU341011Q; 95834102003	Neck length: 127,4 ; with differential lock	1
CAYENNE (92A)	3.0 Diesel	184/250	2014/08-	8DCT	TC00311-RI	0BU341011Q; 95834102003	Neck length: 127,4 ; with differential lock	1
CAYENNE (92A)	3.0 Diesel	193/262	2014/10-	8DCT	TC00311-RI	0BU341011Q; 95834102003	Neck length: 127,4 ; with differential lock	1
CAYENNE (92A)	3.0 Diesel	245/333	2014/09-	8DCT	TC00323-RI	0BU341011M; 95834102012	Neck length: 41,3 ; with differential lock	2
CAYENNE (92A)	3.0 S E-Hybrid	245/333	2010/06-	8DCT	TC00323-RI	0BU341011M; 95834102012	Neck length: 41,3 ; with differential lock	2
CAYENNE (92A)	3.0 S E-Hybrid	306/416	2014/10-	8DCT	TC00323-RI	0BU341011M; 95834102012	Neck length: 41,3 ; with differential lock	2
CAYENNE (92A)	3.0 S	245/333	2011/04-	8DCT	TC00319-RI	0BU341011T; 95834102021	Neck length: 191,2	3
CAYENNE (92A)	3.6 GTS	324/440	2015/02-	8DCT	TC00505-RI	0C2341042F; 958341042; 958341042X	Neck length 111,3 An additional Vent Pipe is needed when changing the Transfer Case. For details please observe manufacturer regulations.	4
CAYENNE (92A)	3.6 S	309/420	2014/10-	8DCT	TC00505-RI	0C2341042F; 958341042; 958341042X	Neck length 111,3 An additional Vent Pipe is needed when changing the Transfer Case. For details please observe manufacturer regulations.	4
CAYENNE (92A)	3.6	220/300	2010/06-2014/12	6MT	TC00300-RI	0C2341042L; 958341042E; 958341042EX	Neck length 139,9 An additional Vent Pipe is needed when changing the Transfer Case. For details please observe manufacturer regulations.	5
CAYENNE (92A)	3.6	220/300	2010/06-2014/12	8DCT	TC00301-RI	0C2341042M; 958341042F; 958341042FX	Neck length 155,7 An additional Vent Pipe is needed when changing the Transfer Case. For details please observe manufacturer regulations.	6
CAYENNE (92A)	3.6	220/300	2015/01-	8DCT	TC00507-RI	0C2341042H; 958341042B; 958341042BX	Neck length 155,7 An additional Vent Pipe is needed when changing the Transfer Case. For details please observe manufacturer regulations.	

All rights reserved.

This publication may not be reproduced in any form, in whole or in part, without a written approval from S-TEC Service Technologies GmbH & Co OG.  
Subject to change without notice!

### Brand - Series - Sales Name

### Maingroup - Subgroup

Salesname	Model	kW/HP	Model Year	Gearbox	Part Number	OEM Number	Info	Image
-----------	-------	-------	------------	---------	-------------	------------	------	-------

### Porsche - Cayenne - CAYENNE (92A)

#### Gearbox, Powertrain - Transfer Case

CAYENNE (92A)	3.6	224/305	2016/01-	8DCT	TC00507-RI	0C2341042H; 958341042B; 958341042BX	Neck length 155,7 An additional Vent Pipe is needed when changing the Transfer Case. For details please observe manufacturer regulations.	
CAYENNE (92A)	4.2 S Diesel	281/382	2012/10-2014/05	8DCT	TC00467-RI	0C2341042N; 958341042G; 958341042GX	Neck length: 155,7 An additional Vent Pipe is needed when changing the Transfer Case. For details please observe manufacturer regulations.	7
CAYENNE (92A)	4.2 S Diesel	283/385	2014/10-	8DCT	TC00506-RI	0C2341042J; 958341042C; 958341042CX	Neck length 155,7 An additional Vent Pipe is needed when changing the Transfer Case. For details please observe manufacturer regulations.	
CAYENNE (92A)	4.8 GTS	309/420	2012/06-2014/12	8DCT	TC00299-RI	0C2341042K; 958341042D; 958341042DX	Neck length 41,3 An additional Vent Pipe is needed when changing the Transfer Case. For details please observe manufacturer regulations.	8
CAYENNE (92A)	4.8 S	294/400	2010/06-2014/05	8DCT	TC00299-RI	0C2341042K; 958341042D; 958341042DX	Neck length 41,3 An additional Vent Pipe is needed when changing the Transfer Case. For details please observe manufacturer regulations.	8
CAYENNE (92A)	4.8 Turbo S	405/550	2012/10-2014/12	8DCT	TC00299-RI	0C2341042K; 958341042D; 958341042DX	Neck length 41,3 An additional Vent Pipe is needed when changing the Transfer Case. For details please observe manufacturer regulations.	8
CAYENNE (92A)	4.8 Turbo S	419/570	2015/01-	8DCT	TC00504-RI	0C2341042G; 958341042A; 958341042AX	Neck length 41,3 An additional Vent Pipe is needed when changing the Transfer Case. For details please observe manufacturer regulations.	
CAYENNE (92A)	4.8 Turbo	368/500	2010/06-2014/05	8DCT	TC00299-RI	0C2341042K; 958341042D; 958341042DX	Neck length 41,3 An additional Vent Pipe is needed when changing the Transfer Case. For details please observe manufacturer regulations.	8
CAYENNE (92A)	4.8 Turbo	382/520	2014/10-	8DCT	TC00504-RI	0C2341042G; 958341042A; 958341042AX	Neck length 41,3 An additional Vent Pipe is needed when changing the Transfer Case. For details please observe manufacturer regulations.	

All rights reserved.

This publication may not be reproduced in any form, in whole or in part, without a written approval from S-TEC Service Technologies GmbH & Co OG.  
Subject to change without notice!

## Brand - Series - Sales Name

### Maingroup - Subgroup

Salesname	Model	kW/HP	Model Year	Gearbox	Part Number	OEM Number	Info	Image
-----------	-------	-------	------------	---------	-------------	------------	------	-------

## Porsche - Cayenne - CAYENNE (92A)

### Gearbox, Powertrain - Transfer Case

CAYENNE (92A)	4.8 Turbo	397/540	2010/06-2014/05	8DCT	TC00299-RI	0C2341042K; 958341042D; 958341042DX	Neck length 41,3 An additional Vent Pipe is needed when changing the Transfer Case. For details please observe manufacturer regulations.	8
---------------	-----------	---------	-----------------	------	------------	---	--	---

## Porsche - Cayenne - CAYENNE (9PA)



Img.1

### Gearbox, Powertrain - Transfer Case

CAYENNE (9PA)	3.2	177/241	2003/08-2007/09	6MT	TC00183-RI	0AD341041Q; 95534104024	Neck length 139,9	1
CAYENNE (9PA)	3.2	184/250	2003/10-2007/09	6MT	TC00183-RI	0AD341041Q; 95534104024	Neck length 139,9	1
CAYENNE (9PA)	3.6	213/290	2007/02-2010/09	6MT	TC00183-RI	0AD341041Q; 95534104024	Neck length 139,9	1
CAYENNE (9PA)	GTS 4.8	298/405	2007/10-2010/09	6MT	TC00182-RI	0AD341041N; 95534104005	Neck length 56,3	1
CAYENNE (9PA)	GTS 4.8	298/405	2007/10-2010/09	6AT	TC00181-RI	0AD341041M; 95534104055	Neck length: 41,3	1
CAYENNE (9PA)	S 4.5	184/250	2002/09-2006/12	6AT	TC00181-RI	0AD341041M; 95534104055	Neck length: 41,3	1
CAYENNE (9PA)	S 4.5	184/250	2002/09-2006/12	6MT	TC00182-RI	0AD341041N; 95534104005	Neck length 56,3	1
CAYENNE (9PA)	S 4.5	250/340	2002/09-2007/09	6AT	TC00181-RI	0AD341041M; 95534104055	Neck length: 41,3	1
CAYENNE (9PA)	S 4.5	250/340	2002/09-2007/09	6MT	TC00182-RI	0AD341041N; 95534104005	Neck length 56,3	1
CAYENNE (9PA)	S 4.8	283/385	2007/02-2010/09	6MT	TC00182-RI	0AD341041N; 95534104005	Neck length 56,3	1
CAYENNE (9PA)	S 4.8	283/385	2007/02-2010/09	6AT	TC00181-RI	0AD341041M; 95534104055	Neck length: 41,3	1
CAYENNE (9PA)	Turbo 4.5	331/450	2002/09-2007/09	6AT	TC00181-RI	0AD341041M; 95534104055	Neck length: 41,3	1
CAYENNE (9PA)	Turbo 4.8	373/507	2007/09-2009/12	6AT	TC00181-RI	0AD341041M; 95534104055	Neck length: 41,3	1
CAYENNE (9PA)	Turbo S 4.5	368/500	2004/01-2007/09	6AT	TC00181-RI	0AD341041M; 95534104055	Neck length: 41,3	1
CAYENNE (9PA)	Turbo S 4.5	383/521	2006/03-2007/09	6AT	TC00181-RI	0AD341041M; 95534104055	Neck length: 41,3	1
CAYENNE (9PA)	Turbo S 4.8	368/500	2007/02-2010/09	6AT	TC00181-RI	0AD341041M; 95534104055	Neck length: 41,3	1
CAYENNE (9PA)	Turbo S 4.8	397/540	2007/02-2010/09	6AT	TC00181-RI	0AD341041M; 95534104055	Neck length: 41,3	1
CAYENNE (9PA)	Turbo S 4.8	404/550	2008/08-2010/09	6AT	TC00181-RI	0AD341041M; 95534104055	Neck length: 41,3	1

All rights reserved.

This publication may not be reproduced in any form, in whole or in part, without a written approval from S-TEC Service Technologies GmbH & Co OG.  
Subject to change without notice!

## Brand - Series - Sales Name

### Maingroup - Subgroup

Salesname	Model	kW/HP	Model Year	Gearbox	Part Number	OEM Number	Info	Image
-----------	-------	-------	------------	---------	-------------	------------	------	-------

## Porsche - Macan - MACAN (95B)



Img.1

### Gearbox, Powertrain - Transfer Case

MACAN (95B)	2.0 (95BAU1)	195/265	2018/05-		TC00570-RI	95B341010T		
MACAN (95B)	2.0 (95BAU1)	195/265	2018/05-		TC00573-RI	95B341010Q; 95B341010QX		
MACAN (95B)	2.0 (95BAU1)	195/265	2018/05-		TC00572-RI	95B341010R; 95B341010RX		
MACAN (95B)	2.0 (95BAU1)	195/265	2018/05-		TC00571-RI	95B341010S		
MACAN (95B)	2.0	174/237	2014/05-2018/09		TC00494-RI	95B341010H		1
MACAN (95B)	2.0	180/245	2018/05-		TC00570-RI	95B341010T		
MACAN (95B)	2.0	180/245	2018/05-		TC00573-RI	95B341010Q; 95B341010QX		
MACAN (95B)	2.0	180/245	2018/05-		TC00571-RI	95B341010S		
MACAN (95B)	2.0	180/245	2018/05-		TC00572-RI	95B341010R; 95B341010RX		
MACAN (95B)	2.9 GTS (95BBL1)	280/380	2019/05-		TC00573-RI	95B341010Q; 95B341010QX		
MACAN (95B)	2.9 GTS (95BBL1)	280/380	2019/05-		TC00572-RI	95B341010R; 95B341010RX		
MACAN (95B)	2.9 Turbo AWD (95BC11)	324/440	2018/05-		TC00572-RI	95B341010R; 95B341010RX		
MACAN (95B)	2.9 Turbo AWD (95BC11)	324/440	2018/05-		TC00570-RI	95B341010T		
MACAN (95B)	2.9 Turbo AWD (95BC11)	324/440	2018/05-		TC00573-RI	95B341010Q; 95B341010QX		
MACAN (95B)	2.9 Turbo AWD (95BC11)	324/440	2018/05-		TC00571-RI	95B341010S		
MACAN (95B)	3.0 GTS	265/360	2015/10-2018/09		TC00494-RI	95B341010H		1
MACAN (95B)	3.0 S Diesel	155/211	2014/02-2018/09		TC00494-RI	95B341010H		1
MACAN (95B)	3.0 S Diesel	180/245	2014/02-2018/09		TC00494-RI	95B341010H		1
MACAN (95B)	3.0 S Diesel	184/250	2014/02-2018/09		TC00494-RI	95B341010H		1
MACAN (95B)	3.0 S Diesel	190/258	2014/02-2018/09		TC00494-RI	95B341010H		1
MACAN (95B)	3.0 S	250/340	2014/02-2018/09		TC00494-RI	95B341010H		1
MACAN (95B)	3.0 S	260/354	2018/05-		TC00570-RI	95B341010T		
MACAN (95B)	3.0 S	260/354	2018/05-		TC00573-RI	95B341010Q; 95B341010QX		
MACAN (95B)	3.0 S	260/354	2018/05-		TC00571-RI	95B341010S		
MACAN (95B)	3.0 S	260/354	2018/05-		TC00572-RI	95B341010R; 95B341010RX		
MACAN (95B)	3.6 Turbo	294/400	2014/02-2018/09		TC00494-RI	95B341010H		1

All rights reserved.

This publication may not be reproduced in any form, in whole or in part, without a written approval from S-TEC Service Technologies GmbH & Co OG.  
Subject to change without notice!

### Brand - Series - Sales Name

### Maingroup - Subgroup

Salesname	Model	kW/HP	Model Year	Gearbox	Part Number	OEM Number	Info	Image
-----------	-------	-------	------------	---------	-------------	------------	------	-------

### Porsche - Panamera - PANAMERA (970)



Img.1

### Front Axle, Steering Unit - Front Differential

PANAMERA (970)	3.0 4S	235/320	2013/10-2016/10	7AT	FD00068-RI	97034901123	i=3,727	1
PANAMERA (970)	3.0 4S	309/420	2013/07-2016/10	7AT	FD00068-RI	97034901123	i=3,727	1
PANAMERA (970)	4.8 4S	294/400	2009/09-2013/07	7AT	FD00068-RI	97034901123	i=3,727	1
PANAMERA (970)	4.8 4S	294/400	2009/09-2013/07	6MT	FD00068-RI	97034901123	i=3,727	1
PANAMERA (970)	4.8 4S	302/411	2009/09-2013/07	7AT	FD00068-RI	97034901123	i=3,727	1
PANAMERA (970)	4.8 GTS	316/430	2012/01-2013/07	7AT	FD00068-RI	97034901123	i=3,727	1
PANAMERA (970)	4.8 GTS	324/440	2013/07-2016/10	7AT	FD00068-RI	97034901123	i=3,727	1

All rights reserved.

This publication may not be reproduced in any form, in whole or in part, without a written approval from S-TEC Service Technologies GmbH & Co OG.  
Subject to change without notice!



### Brand - Series - Sales Name

### Maingroup - Subgroup

Salesname	Model	kW/HP	Model Year	Gearbox	Part Number	OEM Number	Info	Image
-----------	-------	-------	------------	---------	-------------	------------	------	-------

### SEAT - Altea - ALTEA XL (5P5, 5P8)



Img.1

### Front Axle, Steering Unit - Power take off (PTO)

ALTEA XL (5P5, 5P8)	2.0 TDI 16V 4x4	103/140	2010/10-	6MT	FD00052-RI	0AV409053AE		1
ALTEA XL (5P5, 5P8)	2.0 TDI 4x4	103/140	2007/06-	6MT	FD00052-RI	0AV409053AE		1
ALTEA XL (5P5, 5P8)	2.0 TDI 4x4	125/170	2007/06-	6MT	FD00052-RI	0AV409053AE		1
ALTEA XL (5P5, 5P8)	2.0 TFSI 4x4	147/200	2007/06-2009/05	6AT	FD00052-RI	0AV409053AE		1
ALTEA XL (5P5, 5P8)	2.0 TFSI 4x4	155/211	2009/05-	6AT	FD00052-RI	0AV409053AE		1



Img.1



Img.2

### Rear Axle - Rear Differential

ALTEA XL (5P5, 5P8)	2.0 TDI 16V 4x4	103/140	2010/10-	6MT	RD00059-RI	0BR525010G		1
ALTEA XL (5P5, 5P8)	2.0 TDI 4x4	103/140	2007/06-2010/03	6MT	RD00023-RI	0AV525010L		2
ALTEA XL (5P5, 5P8)	2.0 TDI 4x4	103/140	2010/03-	6MT	RD00059-RI	0BR525010G		1
ALTEA XL (5P5, 5P8)	2.0 TDI 4x4	125/170	2007/06-2010/03	6MT	RD00023-RI	0AV525010L		2
ALTEA XL (5P5, 5P8)	2.0 TDI 4x4	125/170	2010/03-	6MT	RD00059-RI	0BR525010G		1
ALTEA XL (5P5, 5P8)	2.0 TFSI 4x4	147/200	2007/06-2009/05	6AT	RD00022-RI	0AV525010K		2
ALTEA XL (5P5, 5P8)	2.0 TFSI 4x4	155/211	2009/05-2010/03	6AT	RD00023-RI	0AV525010L		2
ALTEA XL (5P5, 5P8)	2.0 TFSI 4x4	155/211	2010/03-	6AT	RD00059-RI	0BR525010G		1

All rights reserved.

This publication may not be reproduced in any form, in whole or in part, without a written approval from S-TEC Service Technologies GmbH & Co OG.  
Subject to change without notice!

### Brand - Series - Sales Name

### Maingroup - Subgroup

Salesname	Model	kW/HP	Model Year	Gearbox	Part Number	OEM Number	Info	Image
-----------	-------	-------	------------	---------	-------------	------------	------	-------

### Skoda - Octavia - OCTAVIA Station wagon (1Z5)



Img.1

### Front Axle, Steering Unit - Power take off (PTO)

OCTAVIA Station wagon (1Z5)	1.6 TDI 4x4	77/105	2009/06-2013/02	6MT	FD00052-RI	0AV409053AE		1
OCTAVIA Station wagon (1Z5)	1.8 TSI 4x4	112/152	2009/03-2013/02	6MT	FD00052-RI	0AV409053AE		1
OCTAVIA Station wagon (1Z5)	1.8 TSI 4x4	118/160	2008/11-2013/02	6MT	FD00052-RI	0AV409053AE		1
OCTAVIA Station wagon (1Z5)	1.9 TDI 4x4	77/105	2004/11-2010/12	6MT	FD00052-RI	0AV409053AE		1
OCTAVIA Station wagon (1Z5)	2.0 FSI 4x4	110/150	2004/11-2008/10	6MT	FD00046-RI	0AV409053K		1
OCTAVIA Station wagon (1Z5)	2.0 TDI 16V 4x4	103/140	2010/05-2013/02	6MT	FD00052-RI	0AV409053AE		1
OCTAVIA Station wagon (1Z5)	2.0 TDI 4x4	103/140	2006/07-2010/05	6MT	FD00052-RI	0AV409053AE		1
OCTAVIA Station wagon (1Z5)	2.0 TDI 4x4	81/110	2011/05-2013/02	6MT	FD00052-RI	0AV409053AE		1



Img.1



Img.2

### Rear Axle - Rear Differential

OCTAVIA Station wagon (1Z5)	1.6 TDI 4x4	77/105	2009/06-2013/02	6MT	RD00059-RI	0BR525010G		1
OCTAVIA Station wagon (1Z5)	1.8 TSI 4x4	112/152	2009/03-2013/02	6MT	RD00059-RI	0BR525010G		1
OCTAVIA Station wagon (1Z5)	1.8 TSI 4x4	118/160	2008/11-2013/02	6MT	RD00059-RI	0BR525010G		1
OCTAVIA Station wagon (1Z5)	1.9 TDI 4x4	77/105	2004/11-2008/10	6MT	RD00022-RI	0AV525010K		2
OCTAVIA Station wagon (1Z5)	1.9 TDI 4x4	77/105	2008/11-2010/12	6MT	RD00059-RI	0BR525010G		1
OCTAVIA Station wagon (1Z5)	2.0 FSI 4x4	110/150	2004/11-2008/10	6MT	RD00022-RI	0AV525010K		2
OCTAVIA Station wagon (1Z5)	2.0 TDI 16V 4x4	103/140	2010/05-2013/02	6MT	RD00059-RI	0BR525010G		1
OCTAVIA Station wagon (1Z5)	2.0 TDI 4x4	103/140	2006/07-2008/10	6MT	RD00022-RI	0AV525010K		2
OCTAVIA Station wagon (1Z5)	2.0 TDI 4x4	103/140	2008/11-2010/05	6MT	RD00059-RI	0BR525010G		1
OCTAVIA Station wagon (1Z5)	2.0 TDI 4x4	81/110	2011/05-2013/02	6MT	RD00059-RI	0BR525010G		1

All rights reserved.

This publication may not be reproduced in any form, in whole or in part, without a written approval from S-TEC Service Technologies GmbH & Co OG.  
Subject to change without notice!

### Brand - Series - Sales Name

### Maingroup - Subgroup

Salesname	Model	kW/HP	Model Year	Gearbox	Part Number	OEM Number	Info	Image
-----------	-------	-------	------------	---------	-------------	------------	------	-------

### Skoda - Superb - SUPERB (3T4)



Img.1

#### Front Axle, Steering Unit - Power take off (PTO)

SUPERB (3T4)	1.8 TSI 4x4	112/152	2009/03-2015/05	6MT	FD00052-RI	0AV409053AE		1
SUPERB (3T4)	1.8 TSI 4x4	118/160	2008/11-2015/05	6MT	FD00052-RI	0AV409053AE		1
SUPERB (3T4)	2.0 TDI 16V 4x4	103/140	2010/11-2015/05	6AT	FD00054-RI	0AV409053AG		1
SUPERB (3T4)	2.0 TDI 16V 4x4	103/140	2010/11-2015/05	6MT	FD00052-RI	0AV409053AE		1
SUPERB (3T4)	2.0 TDI 4x4	125/170	2008/09-2015/05	6MT	FD00052-RI	0AV409053AE		1
SUPERB (3T4)	2.0 TDI 4x4	125/170	2008/09-2015/05	6AT	FD00054-RI	0AV409053AG		1
SUPERB (3T4)	3.6 FSI 4x4	191/260	2008/11-2015/05	6AT	FD00054-RI	0AV409053AG		1



Img.1

#### Rear Axle - Rear Differential

SUPERB (3T4)	1.8 TSI 4x4	112/152	2009/03-2015/05	6MT	RD00059-RI	0BR525010G		1
SUPERB (3T4)	1.8 TSI 4x4	118/160	2008/11-2015/05	6MT	RD00059-RI	0BR525010G		1
SUPERB (3T4)	2.0 TDI 16V 4x4	103/140	2010/11-2015/05	6AT	RD00059-RI	0BR525010G		1
SUPERB (3T4)	2.0 TDI 16V 4x4	103/140	2010/11-2015/05	6MT	RD00059-RI	0BR525010G		1
SUPERB (3T4)	2.0 TDI 4x4	125/170	2008/09-2015/05	6AT	RD00059-RI	0BR525010G		1
SUPERB (3T4)	2.0 TDI 4x4	125/170	2008/09-2015/05	6MT	RD00059-RI	0BR525010G		1
SUPERB (3T4)	3.6 FSI 4x4	191/260	2008/11-2015/05	6AT	RD00059-RI	0BR525010G		1

All rights reserved.

This publication may not be reproduced in any form, in whole or in part, without a written approval from S-TEC Service Technologies GmbH & Co OG.  
Subject to change without notice!

### Brand - Series - Sales Name

### Maingroup - Subgroup

Salesname	Model	kW/HP	Model Year	Gearbox	Part Number	OEM Number	Info	Image
-----------	-------	-------	------------	---------	-------------	------------	------	-------

### Skoda - Superb - SUPERB Station wagon (3T5)



Img.1

#### Front Axle, Steering Unit - Power take off (PTO)

SUPERB Station wagon (3T5)	1.8 TSI 4x4	112/152	2009/10-2015/05	6MT	FD00052-RI	0AV409053AE		1
SUPERB Station wagon (3T5)	1.8 TSI 4x4	118/160	2009/10-2015/05	6AT	FD00054-RI	0AV409053AG		1
SUPERB Station wagon (3T5)	1.8 TSI 4x4	118/160	2009/10-2015/05	6MT	FD00052-RI	0AV409053AE		1
SUPERB Station wagon (3T5)	2.0 TDI 16V 4x4	103/140	2010/11-2015/05	6MT	FD00052-RI	0AV409053AE		1
SUPERB Station wagon (3T5)	2.0 TDI 16V 4x4	103/140	2010/11-2015/05	6AT	FD00054-RI	0AV409053AG		1
SUPERB Station wagon (3T5)	2.0 TDI 4x4	125/170	2009/10-2015/05	6MT	FD00052-RI	0AV409053AE		1
SUPERB Station wagon (3T5)	2.0 TDI 4x4	125/170	2009/10-2015/05	6AT	FD00054-RI	0AV409053AG		1
SUPERB Station wagon (3T5)	3.6 V6 4x4	191/260	2009/10-2015/05	6AT	FD00054-RI	0AV409053AG		1



Img.1

#### Rear Axle - Rear Differential

SUPERB Station wagon (3T5)	1.8 TSI 4x4	112/152	2009/10-2015/05	6MT	RD00059-RI	0BR525010G		1
SUPERB Station wagon (3T5)	1.8 TSI 4x4	118/160	2009/10-2015/05	6MT	RD00059-RI	0BR525010G		1
SUPERB Station wagon (3T5)	1.8 TSI 4x4	118/160	2009/10-2015/05	6AT	RD00059-RI	0BR525010G		1
SUPERB Station wagon (3T5)	2.0 TDI 16V 4x4	103/140	2010/11-2015/05	6MT	RD00059-RI	0BR525010G		1
SUPERB Station wagon (3T5)	2.0 TDI 16V 4x4	103/140	2010/11-2015/05	6AT	RD00059-RI	0BR525010G		1
SUPERB Station wagon (3T5)	2.0 TDI 4x4	125/170	2009/10-2015/05	6MT	RD00059-RI	0BR525010G		1
SUPERB Station wagon (3T5)	2.0 TDI 4x4	125/170	2009/10-2015/05	6AT	RD00059-RI	0BR525010G		1
SUPERB Station wagon (3T5)	3.6 V6 4x4	191/260	2009/10-2015/05	6AT	RD00059-RI	0BR525010G		1

All rights reserved.

This publication may not be reproduced in any form, in whole or in part, without a written approval from S-TEC Service Technologies GmbH & Co OG.  
Subject to change without notice!

### Brand - Series - Sales Name

### Maingroup - Subgroup

Salesname	Model	kW/HP	Model Year	Gearbox	Part Number	OEM Number	Info	Image
-----------	-------	-------	------------	---------	-------------	------------	------	-------

### Skoda - Yeti - YETI (5L)



Img.1

### Front Axle, Steering Unit - Power take off (PTO)

YETI (5L)	1.4 TSI 4x4	110/150	2015/05-	6MT	FD00052-RI	0AV409053AE		1
YETI (5L)	1.4 TSI 4x4	110/150	2015/05-	6DCT	FD00054-RI	0AV409053AG		1
YETI (5L)	1.8 TSI 4x4	112/152	2009/11-	6DCT	FD00054-RI	0AV409053AG		1
YETI (5L)	1.8 TSI 4x4	118/160	2009/05-	6MT	FD00052-RI	0AV409053AE		1
YETI (5L)	2.0 TDI 4x4	103/140	2009/05-	6DCT	FD00054-RI	0AV409053AG		1
YETI (5L)	2.0 TDI 4x4	103/140	2009/05-	6MT	FD00052-RI	0AV409053AE		1
YETI (5L)	2.0 TDI 4x4	110/150	2015/05-	6DCT	FD00054-RI	0AV409053AG		1
YETI (5L)	2.0 TDI 4x4	110/150	2015/05-	6MT	FD00052-RI	0AV409053AE		1
YETI (5L)	2.0 TDI 4x4	125/170	2009/11-	6MT	FD00052-RI	0AV409053AE		1
YETI (5L)	2.0 TDI 4x4	125/170	2009/11-	6DCT	FD00054-RI	0AV409053AG		1
YETI (5L)	2.0 TDI 4x4	81/110	2009/11-	6MT	FD00052-RI	0AV409053AE		1



Img.1

### Rear Axle - Rear Differential

YETI (5L)	1.4 TSI 4x4	110/150	2015/05-	6MT	RD00102-RI	0BR525010E		
YETI (5L)	1.4 TSI 4x4	110/150	2015/05-	6DCT	RD00102-RI	0BR525010E		
YETI (5L)	1.8 TSI 4x4	112/152	2009/11-2013/12	6DCT	RD00059-RI	0BR525010G		1
YETI (5L)	1.8 TSI 4x4	112/152	2014/01-	6DCT	RD00102-RI	0BR525010E		
YETI (5L)	1.8 TSI 4x4	118/160	2009/05-2013/12	6MT	RD00059-RI	0BR525010G		1
YETI (5L)	1.8 TSI 4x4	118/160	2014/01-	6MT	RD00102-RI	0BR525010E		
YETI (5L)	2.0 TDI 4x4	103/140	2009/05-2013/12	6DCT	RD00059-RI	0BR525010G		1
YETI (5L)	2.0 TDI 4x4	103/140	2009/05-2013/12	6MT	RD00059-RI	0BR525010G		1
YETI (5L)	2.0 TDI 4x4	103/140	2014/01-	6MT	RD00102-RI	0BR525010E		
YETI (5L)	2.0 TDI 4x4	103/140	2014/01-	6DCT	RD00102-RI	0BR525010E		
YETI (5L)	2.0 TDI 4x4	110/150	2015/05-	6DCT	RD00102-RI	0BR525010E		
YETI (5L)	2.0 TDI 4x4	110/150	2015/05-	6MT	RD00102-RI	0BR525010E		
YETI (5L)	2.0 TDI 4x4	125/170	2009/11-2013/12	6DCT	RD00059-RI	0BR525010G		1
YETI (5L)	2.0 TDI 4x4	125/170	2009/11-2013/12	6MT	RD00059-RI	0BR525010G		1
YETI (5L)	2.0 TDI 4x4	125/170	2014/01-	6MT	RD00102-RI	0BR525010E		
YETI (5L)	2.0 TDI 4x4	125/170	2014/01-	6DCT	RD00102-RI	0BR525010E		
YETI (5L)	2.0 TDI 4x4	81/110	2009/11-2013/12	6MT	RD00059-RI	0BR525010G		1
YETI (5L)	2.0 TDI 4x4	81/110	2014/01-	6MT	RD00102-RI	0BR525010E		

All rights reserved.

This publication may not be reproduced in any form, in whole or in part, without a written approval from S-TEC Service Technologies GmbH & Co OG.  
Subject to change without notice!

## Brand - Series - Sales Name

### Maingroup - Subgroup

Salesname	Model	kW/HP	Model Year	Gearbox	Part Number	OEM Number	Info	Image
-----------	-------	-------	------------	---------	-------------	------------	------	-------

## VW - Amarok - AMAROK



Img.1

### Gearbox, Powertrain - Transfer Case

AMAROK	2.0 BiTDI 4motion	120/163	2010/09-	8AT	TC00316-RI	0BU341011N	Neck length -18,75	1
AMAROK	2.0 BiTDI 4motion	120/163	2010/09-	6MT	TC00316-RI	0BU341011N	Neck length: -18,75	1
AMAROK	2.0 BiTDI 4motion	132/180	2011/11-	8AT	TC00316-RI	0BU341011N	Neck length -18,75	1
AMAROK	2.0 BiTDI 4motion	132/180	2011/11-	6MT	TC00316-RI	0BU341011N	Neck length: -18,75	1
AMAROK	2.0 TDI 4motion	103/140	2012/06-	6MT	TC00316-RI	0BU341011N	Neck length -18,75	1
AMAROK	2.0 TDI 4motion	90/122	2010/09-	6MT	TC00316-RI	0BU341011N	Neck length -18,75	1
AMAROK	2.0 TDI 4motion	90/122	2010/09-	6MT	TC00316-RI	0BU341011N	Neck length: -18,75	1
AMAROK	2.0 TSI 4motion	118/160	2011/09-	6MT	TC00316-RI	0BU341011N	Neck length -18,75	1
AMAROK	3.0 TDI 4motion	120/163	2016/06-	6MT	TC00316-RI	0BU341011N	Neck length -18,75	1
AMAROK	3.0 TDI 4motion	150/204	2016/06-	6MT	TC00316-RI	0BU341011N	Neck length -18,75	1
AMAROK	3.0 TDI 4motion	165/224	2016/06-	6MT	TC00316-RI	0BU341011N	Neck length -18,75	1

## VW - Amarok - AMAROK (2HA, 2HB, S1B, S6B, S7A, S7B)



Img.1

### Gearbox, Powertrain - Transfer Case

AMAROK (2HA, 2HB, S1B, S6B, S7A, S7B)	3.0 TDI 4motion	190/258	2018/05-		TC00316-RI	0BU341011N	Neck length -18,75	1
---	--------------------	---------	----------	--	------------	------------	--------------------	---

All rights reserved.

This publication may not be reproduced in any form, in whole or in part, without a written approval from S-TEC Service Technologies GmbH & Co OG.  
Subject to change without notice!

## Brand - Series - Sales Name

### Maingroup - Subgroup

Salesname	Model	kW/HP	Model Year	Gearbox	Part Number	OEM Number	Info	Image
-----------	-------	-------	------------	---------	-------------	------------	------	-------

## VW - Amarok - AMAROK Flat bed truck



Img.1

### Gearbox, Powertrain - Transfer Case

AMAROK Flat bed truck	2.0 TDI 4motion	103/140	2011/09-	6MT	TC00316-RI	0BU341011N	Neck length -18,75	1
AMAROK Flat bed truck	2.0 TDI 4motion	120/163	2011/09-	6MT	TC00316-RI	0BU341011N	Neck length -18,75	1
AMAROK Flat bed truck	2.0 TDI 4motion	132/180	2011/09-	6MT	TC00316-RI	0BU341011N	Neck length -18,75	1

## VW - Atlas - ATLAS (CA1, CA2, CA3) | TERAMONT

### Rear Axle - Rear Differential

ATLAS (CA1, CA2, CA3)   TERAMONT	2.0 TSI 4motion	162/220	2017/12-		RD00118-RI	0AY525010AE		
ATLAS (CA1, CA2, CA3)   TERAMONT	3.6 FSI 4motion	206/280	2016/12-		RD00118-RI	0AY525010AE		
ATLAS (CA1, CA2, CA3)   TERAMONT	3.6 FSI 4motion	183/249	2019/01-		RD00118-RI	0AY525010AE		

## VW - Caddy - CADDY III Mini van (2KB, 2KJ, 2CB, 2CJ)



Img.1

### Front Axle, Steering Unit - Power take off (PTO)

CADDY III Mini van (2KB, 2KJ, 2CB, 2CJ)	1.9 TDI 4motion	77/105	2008/05-2010/08	6MT	FD00052-RI	0AV409053AE		1
CADDY III Mini van (2KB, 2KJ, 2CB, 2CJ)	2.0 TDI 16V 4motion	103/140	2010/11-2015/05	6MT	FD00053-RI	0AV409053AF		1
CADDY III Mini van (2KB, 2KJ, 2CB, 2CJ)	2.0 TDI 4motion	81/110	2010/08-2015/05	6MT	FD00052-RI	0AV409053AE		1

All rights reserved.

This publication may not be reproduced in any form, in whole or in part, without a written approval from S-TEC Service Technologies GmbH & Co OG. Subject to change without notice!

### Brand - Series - Sales Name

### Maingroup - Subgroup

Salesname	Model	kW/HP	Model Year	Gearbox	Part Number	OEM Number	Info	Image
-----------	-------	-------	------------	---------	-------------	------------	------	-------

### VW - Caddy - CADDY III Station wagon (2KA, 2KH, 2CA, 2CH)



Img.1

### Front Axle, Steering Unit - Power take off (PTO)

CADDY III Station wagon (2KA, 2KH, 2CA, 2CH)	1.9 TDI 4motion	77/105	2008/11-2010/08	6MT	FD00052-RI	0AV409053AE		1
CADDY III Station wagon (2KA, 2KH, 2CA, 2CH)	2.0 TDI 16V 4motion	103/140	2010/11-2015/05	6MT	FD00053-RI	0AV409053AF		1
CADDY III Station wagon (2KA, 2KH, 2CA, 2CH)	2.0 TDI 4motion	62/85	2010/12-2015/05	6MT	FD00052-RI	0AV409053AE		1
CADDY III Station wagon (2KA, 2KH, 2CA, 2CH)	2.0 TDI 4motion	81/110	2010/08-2015/05	6MT	FD00052-RI	0AV409053AE		1

### VW - Caddy - CADDY IV Großraumlimousine (SAB, SAJ)



Img.1

### Front Axle, Steering Unit - Power take off (PTO)

CADDY IV Großraumlimousine (SAB, SAJ)	2.0 TDI 4motion	81/110	2015/05-2020/09		FD00052-RI	0AV409053AE		1
---------------------------------------	-----------------	--------	-----------------	--	------------	-------------	--	---

### VW - Caddy - CADDY IV Kasten/Großraumlimousine (SAA, SAH)



Img.1

### Front Axle, Steering Unit - Power take off (PTO)

CADDY IV Kasten/Großraumlimousine (SAA, SAH)	2.0 TDI 4motion	81/110	2015/05-2020/09		FD00052-RI	0AV409053AE		1
--	-----------------	--------	-----------------	--	------------	-------------	--	---

All rights reserved.

This publication may not be reproduced in any form, in whole or in part, without a written approval from S-TEC Service Technologies GmbH & Co OG.  
Subject to change without notice!



### Brand - Series - Sales Name

### Maingroup - Subgroup

Salesname	Model	kW/HP	Model Year	Gearbox	Part Number	OEM Number	Info	Image
-----------	-------	-------	------------	---------	-------------	------------	------	-------

### VW - Golf - GOLF IV (1J1)



Img.1

### Front Axle, Steering Unit - Power take off (PTO)

GOLF IV (1J1)	3.2 R32 4motion	177/241	2002/09-2005/06	6AT	FD00041-RI	02M409050X; 02M409053AP		1
GOLF IV (1J1)	3.2 R32 4motion	179/243	2002/09-2003/12	6AT	FD00041-RI	02M409050X; 02M409053AP		1

All rights reserved.

This publication may not be reproduced in any form, in whole or in part, without a written approval from S-TEC Service Technologies GmbH & Co OG.  
Subject to change without notice!

### Brand - Series - Sales Name

### Maingroup - Subgroup

Salesname	Model	kW/HP	Model Year	Gearbox	Part Number	OEM Number	Info	Image
-----------	-------	-------	------------	---------	-------------	------------	------	-------

### VW - Golf - GOLF V (1K1)



Img.1

### Front Axle, Steering Unit - Power take off (PTO)

GOLF V (1K1)	1.9 TDI 4motion	77/105	2004/08-2008/11	6MT	FD00052-RI	0AV409053AE		1
GOLF V (1K1)	2.0 FSI 4motion	110/150	2004/08-2008/11	6MT	FD00046-RI	0AV409053K		1
GOLF V (1K1)	2.0 TDI 16V 4motion	103/140	2004/08-2008/11	6MT	FD00052-RI	0AV409053AE		1
GOLF V (1K1)	2.0 TDI 4motion	103/140	2004/08-2008/11	6MT	FD00052-RI	0AV409053AE		1
GOLF V (1K1)	3.2 R32 4motion	177/241	2004/01-2008/11	6MT	FD00052-RI	0AV409053AE		1
GOLF V (1K1)	3.2 R32 4motion	177/241	2004/01-2008/11	6AT	FD00053-RI	0AV409053AF		1
GOLF V (1K1)	3.2 R32 4motion	184/250	2005/11-2008/11	6MT	FD00052-RI	0AV409053AE		1
GOLF V (1K1)	3.2 R32 4motion	184/250	2005/11-2008/11	6AT	FD00053-RI	0AV409053AF		1



Img.1

### Rear Axle - Rear Differential

GOLF V (1K1)	1.9 TDI 4motion	77/105	2004/08-2008/11	6MT	RD00023-RI	0AV525010L		1
GOLF V (1K1)	2.0 FSI 4motion	110/150	2004/08-2008/11	6MT	RD00022-RI	0AV525010K		1
GOLF V (1K1)	2.0 TDI 16V 4motion	103/140	2004/08-2008/11	6MT	RD00023-RI	0AV525010L		1
GOLF V (1K1)	2.0 TDI 4motion	103/140	2004/08-2008/11	6MT	RD00023-RI	0AV525010L		1
GOLF V (1K1)	3.2 R32 4motion	177/241	2004/01-2008/11	6AT	RD00022-RI	0AV525010K		1
GOLF V (1K1)	3.2 R32 4motion	177/241	2004/01-2008/11	6MT	RD00022-RI	0AV525010K		1
GOLF V (1K1)	3.2 R32 4motion	184/250	2005/11-2008/11	6AT	RD00022-RI	0AV525010K		1
GOLF V (1K1)	3.2 R32 4motion	184/250	2005/11-2008/11	6MT	RD00022-RI	0AV525010K		1

### VW - Golf - GOLF V Variant (1K5)



Img.1

### Front Axle, Steering Unit - Power take off (PTO)

GOLF V Variant (1K5)	1.9 TDI 4motion	77/105	2008/01-2009/07	6MT	FD00052-RI	0AV409053AE		1
----------------------	--------------------	--------	-----------------	-----	------------	-------------	--	---

All rights reserved.

This publication may not be reproduced in any form, in whole or in part, without a written approval from S-TEC Service Technologies GmbH & Co OG.  
Subject to change without notice!

## Brand - Series - Sales Name

### Maingroup - Subgroup

Salesname	Model	kW/HP	Model Year	Gearbox	Part Number	OEM Number	Info	Image
-----------	-------	-------	------------	---------	-------------	------------	------	-------

## VW - Golf - GOLF VI (5K1)



Img.1

### Front Axle, Steering Unit - Power take off (PTO)

GOLF VI (5K1)	2.0 4motion	191/260	2011/09-2013/11	6MT	FD00052-RI	0AV409053AE		1
GOLF VI (5K1)	2.0 R 4motion	188/256	2009/11-2013/11	6MT	FD00052-RI	0AV409053AE		1
GOLF VI (5K1)	2.0 R 4motion	188/256	2009/11-2013/11	6AT	FD00053-RI	0AV409053AF		1
GOLF VI (5K1)	2.0 R 4motion	195/265	2009/11-2011/05	6MT	FD00052-RI	0AV409053AE		1
GOLF VI (5K1)	2.0 R 4motion	199/270	2009/11-2012/11	6AT	FD00053-RI	0AV409053AF		1
GOLF VI (5K1)	2.0 R 4motion	199/270	2009/11-2012/11	6MT	FD00052-RI	0AV409053AE		1
GOLF VI (5K1)	2.0 TDI 4motion	103/140	2009/05-2012/11	6MT	FD00052-RI	0AV409053AE		1



Img.1

### Rear Axle - Rear Differential

GOLF VI (5K1)	2.0 4motion	191/260	2011/09-2013/11	6MT	RD00059-RI	0BR525010G		1
GOLF VI (5K1)	2.0 R 4motion	188/256	2009/11-2013/11	6AT	RD00059-RI	0BR525010G		1
GOLF VI (5K1)	2.0 R 4motion	188/256	2009/11-2013/11	6MT	RD00059-RI	0BR525010G		1
GOLF VI (5K1)	2.0 R 4motion	195/265	2009/11-2011/05	6MT	RD00059-RI	0BR525010G		1
GOLF VI (5K1)	2.0 R 4motion	199/270	2009/11-2012/11	6AT	RD00059-RI	0BR525010G		1
GOLF VI (5K1)	2.0 R 4motion	199/270	2009/11-2012/11	6MT	RD00059-RI	0BR525010G		1
GOLF VI (5K1)	2.0 TDI 4motion	103/140	2009/05-2012/11	6MT	RD00059-RI	0BR525010G		1

## VW - Golf - GOLF VI Variant (AJ5)



Img.1

### Front Axle, Steering Unit - Power take off (PTO)

GOLF VI Variant (AJ5)	1.6 TDI 4motion	77/105	2009/07-2013/07	6MT	FD00052-RI	0AV409053AE		1
--------------------------	--------------------	--------	-----------------	-----	------------	-------------	--	---



Img.1

### Rear Axle - Rear Differential

GOLF VI Variant (AJ5)	1.6 TDI 4motion	77/105	2009/07-2013/07	6MT	RD00059-RI	0BR525010G		1
--------------------------	--------------------	--------	-----------------	-----	------------	------------	--	---

All rights reserved.

This publication may not be reproduced in any form, in whole or in part, without a written approval from S-TEC Service Technologies GmbH & Co OG.  
Subject to change without notice!

### Brand - Series - Sales Name

### Maingroup - Subgroup

Salesname	Model	kW/HP	Model Year	Gearbox	Part Number	OEM Number	Info	Image
-----------	-------	-------	------------	---------	-------------	------------	------	-------

### VW - Passat - PASSAT (362)



Img.1

### Front Axle, Steering Unit - Power take off (PTO)

PASSAT (362)	2.0 TDI 4motion	103/140	2010/08-2014/12	6MT	FD00052-RI	0AV409053AE		1
PASSAT (362)	2.0 TDI 4motion	125/170	2010/08-2013/01	6MT	FD00052-RI	0AV409053AE		1
PASSAT (362)	2.0 TDI 4motion	125/170	2010/08-2013/01	6AT	FD00053-RI	0AV409053AF		1
PASSAT (362)	2.0 TDI 4motion	130/177	2013/01-2014/12	6AT	FD00053-RI	0AV409053AF		1
PASSAT (362)	3.6 FSI 4motion	220/300	2011/01-2014/12	6AT	FD00053-RI	0AV409053AF		1



Img.1

### Rear Axle - Rear Differential

PASSAT (362)	2.0 TDI 4motion	103/140	2010/08-2014/12	6MT	RD00061-RI	0BS525010G		1
PASSAT (362)	2.0 TDI 4motion	125/170	2010/08-2013/01	6AT	RD00061-RI	0BS525010G		1
PASSAT (362)	2.0 TDI 4motion	125/170	2010/08-2013/01	6MT	RD00061-RI	0BS525010G		1
PASSAT (362)	2.0 TDI 4motion	130/177	2013/01-2014/12	6AT	RD00061-RI	0BS525010G		1
PASSAT (362)	3.6 FSI 4motion	220/300	2011/01-2014/12	6AT	RD00061-RI	0BS525010G		1

All rights reserved.

This publication may not be reproduced in any form, in whole or in part, without a written approval from S-TEC Service Technologies GmbH & Co OG.  
Subject to change without notice!

### Brand - Series - Sales Name

### Maingroup - Subgroup

Salesname	Model	kW/HP	Model Year	Gearbox	Part Number	OEM Number	Info	Image
-----------	-------	-------	------------	---------	-------------	------------	------	-------

### VW - Passat - PASSAT (3C2)



Img.1



Img.2

### Front Axle, Steering Unit - Power take off (PTO)

PASSAT (3C2)	2.0 FSI 4motion	110/150	2005/09-2010/07	6MT	FD00046-RI	0AV409053K		1
PASSAT (3C2)	2.0 TDI 16V 4motion	103/140	2005/03-2008/02	6AT	FD00052-RI	0AV409053AE		1
PASSAT (3C2)	2.0 TDI 16V 4motion	103/140	2005/03-2008/02	6MT	FD00052-RI	0AV409053AE		1
PASSAT (3C2)	2.0 TDI 16V 4motion	103/140	2008/02-2010/08	6MT	FD00046-RI	0AV409053K		1
PASSAT (3C2)	2.0 TDI 16V 4motion	103/140	2008/02-2010/08	6AT	FD00046-RI	0AV409053K		1
PASSAT (3C2)	2.0 TDI 4motion	103/140	2005/03-2009/05	6AT	FD00052-RI	0AV409053AE		1
PASSAT (3C2)	2.0 TDI 4motion	103/140	2005/03-2009/05	6MT	FD00052-RI	0AV409053AE		1
PASSAT (3C2)	2.0 TDI 4motion	125/170	2009/05-2010/07	6MT	FD00046-RI	0AV409053K		1
PASSAT (3C2)	2.0 TDI 4motion	125/170	2009/05-2010/07	6AT	FD00046-RI	0AV409053K		1
PASSAT (3C2)	3.2 FSI 4motion	184/250	2005/11-2010/07	6AT	FD00053-RI	0AV409053AF		1
PASSAT (3C2)	3.6 FSI 4motion	206/280	2005/09-2010/07	6AT	FD00051-RI	0AU409053T		2
PASSAT (3C2)	3.6 R36 4motion	220/300	2007/04-2010/07	6AT	FD00053-RI	0AV409053AF		1



Img.1



Img.2



Img.3

### Rear Axle - Rear Differential

PASSAT (3C2)	2.0 FSI 4motion	110/150	2005/09-2006/05	6MT	RD00022-RI	0AV525010K		1
PASSAT (3C2)	2.0 FSI 4motion	110/150	2006/05-2008/06	6MT	RD00042-RI	01Z525010J	No complete unit, only single parts available! For details please see 4WD Single Parts catalogue.	2
PASSAT (3C2)	2.0 FSI 4motion	110/150	2008/06-2010/07	6MT	RD00061-RI	0BS525010G		3
PASSAT (3C2)	2.0 TDI 16V 4motion	103/140	2005/03-2006/05	6AT	RD00023-RI	0AV525010L		1
PASSAT (3C2)	2.0 TDI 16V 4motion	103/140	2005/03-2006/05	6MT	RD00023-RI	0AV525010L		1
PASSAT (3C2)	2.0 TDI 16V 4motion	103/140	2006/05-2008/05	6AT	RD00043-RI	01Z525010K		2
PASSAT (3C2)	2.0 TDI 16V 4motion	103/140	2006/05-2008/05	6MT	RD00043-RI	01Z525010K		2
PASSAT (3C2)	2.0 TDI 16V 4motion	103/140	2008/05-2010/08	6MT	RD00061-RI	0BS525010G		3
PASSAT (3C2)	2.0 TDI 16V 4motion	103/140	2008/05-2010/08	6AT	RD00061-RI	0BS525010G		3
PASSAT (3C2)	2.0 TDI 4motion	103/140	2005/03-2006/05	6MT	RD00023-RI	0AV525010L		1
PASSAT (3C2)	2.0 TDI 4motion	103/140	2005/03-2006/05	6AT	RD00023-RI	0AV525010L		1

All rights reserved.

This publication may not be reproduced in any form, in whole or in part, without a written approval from S-TEC Service Technologies GmbH & Co OG.  
Subject to change without notice!

### Brand - Series - Sales Name

### Maingroup - Subgroup

Salesname	Model	kW/HP	Model Year	Gearbox	Part Number	OEM Number	Info	Image
-----------	-------	-------	------------	---------	-------------	------------	------	-------

### VW - Passat - PASSAT (3C2)

#### Rear Axle - Rear Differential

PASSAT (3C2)	2.0 TDI 4motion	103/140	2006/05-2008/06	6MT	RD00043-RI	01Z525010K		2
PASSAT (3C2)	2.0 TDI 4motion	103/140	2006/05-2008/06	6AT	RD00043-RI	01Z525010K		2
PASSAT (3C2)	2.0 TDI 4motion	103/140	2008/06-2009/05	6AT	RD00061-RI	0BS525010G		3
PASSAT (3C2)	2.0 TDI 4motion	103/140	2008/06-2009/05	6MT	RD00061-RI	0BS525010G		3
PASSAT (3C2)	2.0 TDI 4motion	125/170	2009/05-2010/07	6AT	RD00061-RI	0BS525010G		3
PASSAT (3C2)	2.0 TDI 4motion	125/170	2009/05-2010/07	6MT	RD00061-RI	0BS525010G		3
PASSAT (3C2)	3.2 FSI 4motion	184/250	2005/11-2006/05	6AT	RD00022-RI	0AV525010K		1
PASSAT (3C2)	3.2 FSI 4motion	184/250	2006/05-2008/06	6AT	RD00042-RI	01Z525010J	No complete unit, only single parts available! For details please see 4WD Single Parts catalogue.	2
PASSAT (3C2)	3.2 FSI 4motion	184/250	2008/06-2010/07	6AT	RD00061-RI	0BS525010G		3
PASSAT (3C2)	3.6 FSI 4motion	206/280	2005/09-2008/06	6AT	RD00040-RI	01Z525010D	No complete unit, only single parts available! For details please see 4WD Single Parts catalogue.	2
PASSAT (3C2)	3.6 FSI 4motion	206/280	2008/06-2010/07	6AT	RD00061-RI	0BS525010G		3
PASSAT (3C2)	3.6 R36 4motion	220/300	2007/04-2008/06	6AT	RD00042-RI	01Z525010J	No complete unit, only single parts available! For details please see 4WD Single Parts catalogue.	2
PASSAT (3C2)	3.6 R36 4motion	220/300	2008/06-2010/07	6AT	RD00061-RI	0BS525010G		3

All rights reserved.

This publication may not be reproduced in any form, in whole or in part, without a written approval from S-TEC Service Technologies GmbH & Co OG.  
Subject to change without notice!

### Brand - Series - Sales Name

### Maingroup - Subgroup

Salesname	Model	kW/HP	Model Year	Gearbox	Part Number	OEM Number	Info	Image
-----------	-------	-------	------------	---------	-------------	------------	------	-------

### VW - Passat - PASSAT ALLTRACK (365)



Img.1

### Front Axle, Steering Unit - Power take off (PTO)

PASSAT ALLTRACK (365)	2.0 TDI 4motion	103/140	2012/01-2014/12	6MT	FD00052-RI	0AV409053AE		1
PASSAT ALLTRACK (365)	2.0 TDI 4motion	125/170	2012/01-2014/12	6AT	FD00053-RI	0AV409053AF		1
PASSAT ALLTRACK (365)	2.0 TDI 4motion	125/170	2012/01-2014/12	6MT	FD00052-RI	0AV409053AE		1
PASSAT ALLTRACK (365)	2.0 TDI 4motion	130/177	2013/01-2014/12	6AT	FD00053-RI	0AV409053AF		1
PASSAT ALLTRACK (365)	2.0 TSI 4motion	155/210	2012/01-2014/12	6AT	FD00053-RI	0AV409053AF		1



Img.1

### Rear Axle - Rear Differential

PASSAT ALLTRACK (365)	2.0 TDI 4motion	103/140	2012/01-2014/12	6MT	RD00061-RI	0BS525010G		1
PASSAT ALLTRACK (365)	2.0 TDI 4motion	125/170	2012/01-2014/12	6AT	RD00061-RI	0BS525010G		1
PASSAT ALLTRACK (365)	2.0 TDI 4motion	125/170	2012/01-2014/12	6MT	RD00061-RI	0BS525010G		1
PASSAT ALLTRACK (365)	2.0 TDI 4motion	130/177	2013/01-2014/12	6AT	RD00061-RI	0BS525010G		1
PASSAT ALLTRACK (365)	2.0 TSI 4motion	155/210	2012/01-2014/12	6AT	RD00061-RI	0BS525010G		1

### VW - Passat - PASSAT B6 Variant (3C5)



Img.1

### Rear Axle - Rear Differential

PASSAT B6 Variant (3C5)	2.0 TDI 16V	103/140	2005/08-2010/11		RD00061-RI	0BS525010G		1
-------------------------	-------------	---------	-----------------	--	------------	------------	--	---

All rights reserved.

This publication may not be reproduced in any form, in whole or in part, without a written approval from S-TEC Service Technologies GmbH & Co OG.  
Subject to change without notice!

### Brand - Series - Sales Name

### Maingroup - Subgroup

Salesname	Model	kW/HP	Model Year	Gearbox	Part Number	OEM Number	Info	Image
-----------	-------	-------	------------	---------	-------------	------------	------	-------

### VW - Passat - PASSAT Variant (365)



Img.1

### Front Axle, Steering Unit - Power take off (PTO)

PASSAT Variant (365)	2.0 TDI 4motion	103/140	2010/08-2014/12	6MT	FD00052-RI	0AV409053AE		1
PASSAT Variant (365)	2.0 TDI 4motion	125/170	2010/08-2013/01	6MT	FD00052-RI	0AV409053AE		1
PASSAT Variant (365)	2.0 TDI 4motion	125/170	2010/08-2013/01	6AT	FD00053-RI	0AV409053AF		1
PASSAT Variant (365)	2.0 TDI 4motion	130/177	2013/01-2014/12	6AT	FD00053-RI	0AV409053AF		1
PASSAT Variant (365)	3.6 FSI 4motion	220/300	2011/01-2014/12	6AT	FD00053-RI	0AV409053AF		1



Img.1

### Rear Axle - Rear Differential

PASSAT Variant (365)	2.0 TDI 4motion	103/140	2010/08-2014/12	6MT	RD00061-RI	0BS525010G		1
PASSAT Variant (365)	2.0 TDI 4motion	125/170	2010/08-2013/01	6AT	RD00061-RI	0BS525010G		1
PASSAT Variant (365)	2.0 TDI 4motion	125/170	2010/08-2013/01	6MT	RD00061-RI	0BS525010G		1
PASSAT Variant (365)	2.0 TDI 4motion	130/177	2013/01-2014/12	6AT	RD00061-RI	0BS525010G		1
PASSAT Variant (365)	3.6 FSI 4motion	220/300	2011/01-2014/12	6AT	RD00061-RI	0BS525010G		1

All rights reserved.

This publication may not be reproduced in any form, in whole or in part, without a written approval from S-TEC Service Technologies GmbH & Co OG.  
Subject to change without notice!



### Brand - Series - Sales Name

### Maingroup - Subgroup

Salesname	Model	kW/HP	Model Year	Gearbox	Part Number	OEM Number	Info	Image
-----------	-------	-------	------------	---------	-------------	------------	------	-------

### VW - Passat - PASSAT Variant (3C5)



Img.1



Img.2

### Front Axle, Steering Unit - Power take off (PTO)

PASSAT Variant (3C5)	2.0 FSI 4motion	110/150	2005/09-2010/11	6MT	FD00046-RI	0AV409053K		1
PASSAT Variant (3C5)	2.0 TDI 16V 4motion	103/140	2005/08-2008/02	6MT	FD00052-RI	0AV409053AE		1
PASSAT Variant (3C5)	2.0 TDI 16V 4motion	103/140	2005/08-2008/02	6AT	FD00052-RI	0AV409053AE		1
PASSAT Variant (3C5)	2.0 TDI 16V 4motion	103/140	2008/02-2010/11	6MT	FD00046-RI	0AV409053K		1
PASSAT Variant (3C5)	2.0 TDI 16V 4motion	103/140	2008/02-2010/11	6AT	FD00046-RI	0AV409053K		1
PASSAT Variant (3C5)	2.0 TDI 4motion	103/140	2005/08-2009/05	6AT	FD00052-RI	0AV409053AE		1
PASSAT Variant (3C5)	2.0 TDI 4motion	103/140	2005/08-2009/05	6MT	FD00052-RI	0AV409053AE		1
PASSAT Variant (3C5)	2.0 TDI 4motion	125/170	2009/05-2010/11	6AT	FD00046-RI	0AV409053K		1
PASSAT Variant (3C5)	2.0 TDI 4motion	125/170	2009/05-2010/11	6MT	FD00046-RI	0AV409053K		1
PASSAT Variant (3C5)	3.2 FSI 4motion	184/250	2005/11-2010/11	6AT	FD00053-RI	0AV409053AF		1
PASSAT Variant (3C5)	3.6 FSI 4motion	206/280	2005/09-2010/11	6AT	FD00051-RI	0AU409053T		2
PASSAT Variant (3C5)	3.6 R36 4motion	220/300	2007/04-2010/11	6AT	FD00053-RI	0AV409053AF		1



Img.1



Img.2



Img.3

### Rear Axle - Rear Differential

PASSAT Variant (3C5)	2.0 FSI 4motion	110/150	2005/09-2006/05	6MT	RD00022-RI	0AV525010K		1
PASSAT Variant (3C5)	2.0 FSI 4motion	110/150	2006/05-2008/06	6MT	RD00042-RI	01Z525010J	No complete unit, only single parts available! For details please see 4WD Single Parts catalogue.	2
PASSAT Variant (3C5)	2.0 FSI 4motion	110/150	2008/06-2010/11	6MT	RD00061-RI	0BS525010G		3
PASSAT Variant (3C5)	2.0 TDI 16V 4motion	103/140	2005/08-2006/05	6AT	RD00023-RI	0AV525010L		1
PASSAT Variant (3C5)	2.0 TDI 16V 4motion	103/140	2005/08-2006/05	6MT	RD00023-RI	0AV525010L		1
PASSAT Variant (3C5)	2.0 TDI 16V 4motion	103/140	2006/05-2010/11	6AT	RD00043-RI	01Z525010K		2
PASSAT Variant (3C5)	2.0 TDI 16V 4motion	103/140	2006/05-2010/11	6MT	RD00043-RI	01Z525010K		2
PASSAT Variant (3C5)	2.0 TDI 16V 4motion	103/140	2008/06-2010/11	6MT	RD00061-RI	0BS525010G		3
PASSAT Variant (3C5)	2.0 TDI 16V 4motion	103/140	2008/06-2010/11	6AT	RD00061-RI	0BS525010G		3

All rights reserved.

This publication may not be reproduced in any form, in whole or in part, without a written approval from S-TEC Service Technologies GmbH & Co OG. Subject to change without notice!

### Brand - Series - Sales Name

### Maingroup - Subgroup

Salesname	Model	kW/HP	Model Year	Gearbox	Part Number	OEM Number	Info	Image
-----------	-------	-------	------------	---------	-------------	------------	------	-------

### VW - Passat - PASSAT Variant (3C5)

#### Rear Axle - Rear Differential

PASSAT Variant (3C5)	2.0 TDI 4motion	103/140	2005/08-2006/05	6AT	RD00023-RI	0AV525010L		1
PASSAT Variant (3C5)	2.0 TDI 4motion	103/140	2005/08-2006/05	6MT	RD00023-RI	0AV525010L		1
PASSAT Variant (3C5)	2.0 TDI 4motion	103/140	2006/05-2008/06	6AT	RD00043-RI	01Z525010K		2
PASSAT Variant (3C5)	2.0 TDI 4motion	103/140	2006/05-2008/06	6MT	RD00043-RI	01Z525010K		2
PASSAT Variant (3C5)	2.0 TDI 4motion	103/140	2008/06-2009/05	6MT	RD00061-RI	0BS525010G		3
PASSAT Variant (3C5)	2.0 TDI 4motion	103/140	2008/06-2009/05	6AT	RD00061-RI	0BS525010G		3
PASSAT Variant (3C5)	2.0 TDI 4motion	125/170	2009/05-2010/11	6MT	RD00061-RI	0BS525010G		3
PASSAT Variant (3C5)	2.0 TDI 4motion	125/170	2009/05-2010/11	6AT	RD00061-RI	0BS525010G		3
PASSAT Variant (3C5)	3.2 FSI 4motion	184/250	2005/11-2006/05	6AT	RD00022-RI	0AV525010K		1
PASSAT Variant (3C5)	3.2 FSI 4motion	184/250	2006/05-2008/06	6AT	RD00042-RI	01Z525010J	No complete unit, only single parts available! For details please see 4WD Single Parts catalogue.	2
PASSAT Variant (3C5)	3.2 FSI 4motion	184/250	2008/06-2010/11	6AT	RD00061-RI	0BS525010G		3
PASSAT Variant (3C5)	3.6 FSI 4motion	206/280	2005/09-2006/05	6AT	RD00022-RI	0AV525010K		1
PASSAT Variant (3C5)	3.6 FSI 4motion	206/280	2006/05-2008/06	6AT	RD00042-RI	01Z525010J	No complete unit, only single parts available! For details please see 4WD Single Parts catalogue.	2
PASSAT Variant (3C5)	3.6 FSI 4motion	206/280	2008/06-2010/11	6AT	RD00061-RI	0BS525010G		3
PASSAT Variant (3C5)	3.6 R36 4motion	220/300	2007/04-2008/06	6AT	RD00042-RI	01Z525010J	No complete unit, only single parts available! For details please see 4WD Single Parts catalogue.	2
PASSAT Variant (3C5)	3.6 R36 4motion	220/300	2008/06-2010/11	6AT	RD00061-RI	0BS525010G		3

All rights reserved.

This publication may not be reproduced in any form, in whole or in part, without a written approval from S-TEC Service Technologies GmbH & Co OG.  
Subject to change without notice!

### Brand - Series - Sales Name

### Maingroup - Subgroup

Salesname	Model	kW/HP	Model Year	Gearbox	Part Number	OEM Number	Info	Image
-----------	-------	-------	------------	---------	-------------	------------	------	-------

### VW - Sharan - SHARAN (7N1, 7N2)



Img.1

### Front Axle, Steering Unit - Power take off (PTO)

SHARAN (7N1, 7N2)	2.0 TDI 4motion	103/140	2011/05-	6MT	FD00049-RI	0A6409053AG		1
SHARAN (7N1, 7N2)	2.0 TDI 4motion	110/150	2015/05-	6MT	FD00049-RI	0A6409053AG		1
SHARAN (7N1, 7N2)	2.0 TDI 4motion	135/184	2016/05-	6MT	FD00049-RI	0A6409053AG		1



Img.1

### Rear Axle - Rear Differential

SHARAN (7N1, 7N2)	2.0 TDI 4motion	103/140	2011/05-2013/11	6MT	RD00058-RI	0AY525010L		1
SHARAN (7N1, 7N2)	2.0 TDI 4motion	103/140	2013/11-	6MT	RD00100-RI	0AY525010N		1
SHARAN (7N1, 7N2)	2.0 TDI 4motion	110/150	2015/05-	6MT	RD00100-RI	0AY525010N		1
SHARAN (7N1, 7N2)	2.0 TDI 4motion	135/184	2016/05-	6MT	RD00100-RI	0AY525010N		1

All rights reserved.

This publication may not be reproduced in any form, in whole or in part, without a written approval from S-TEC Service Technologies GmbH & Co OG.  
Subject to change without notice!

### Brand - Series - Sales Name

### Maingroup - Subgroup

Salesname	Model	kW/HP	Model Year	Gearbox	Part Number	OEM Number	Info	Image
-----------	-------	-------	------------	---------	-------------	------------	------	-------

### VW - Tiguan - TIGUAN (5N\_)



Img.1

### Front Axle, Steering Unit - Power take off (PTO)

TIGUAN (5N_)	1.4 TSI 4motion	110/150	2007/09-	6MT	FD00049-RI	0A6409053AG		1
TIGUAN (5N_)	1.4 TSI 4motion	118/160	2011/05-	6MT	FD00049-RI	0A6409053AG		1
TIGUAN (5N_)	2.0 TDI 4motion	100/136	2007/11-	7AT	FD00060-RI	0A6409053AH		1
TIGUAN (5N_)	2.0 TDI 4motion	100/136	2007/11-	6MT	FD00049-RI	0A6409053AG		1
TIGUAN (5N_)	2.0 TDI 4motion	103/140	2007/09-	6MT	FD00049-RI	0A6409053AG		1
TIGUAN (5N_)	2.0 TDI 4motion	103/140	2007/09-	7AT	FD00060-RI	0A6409053AH		1
TIGUAN (5N_)	2.0 TDI 4motion	110/150	2015/05-	6MT	FD00049-RI	0A6409053AG		1
TIGUAN (5N_)	2.0 TDI 4motion	110/150	2015/05-	7AT	FD00060-RI	0A6409053AH		1
TIGUAN (5N_)	2.0 TDI 4motion	120/163	2008/02-2009/08	6MT	FD00049-RI	0A6409053AG		1
TIGUAN (5N_)	2.0 TDI 4motion	125/170	2007/09-	6MT	FD00049-RI	0A6409053AG		1
TIGUAN (5N_)	2.0 TDI 4motion	125/170	2007/09-	6AT	FD00051-RI	0AU409053T		1
TIGUAN (5N_)	2.0 TDI 4motion	130/177	2012/11-	6MT	FD00049-RI	0A6409053AG		1
TIGUAN (5N_)	2.0 TDI 4motion	130/177	2012/11-	7AT	FD00060-RI	0A6409053AH		1
TIGUAN (5N_)	2.0 TDI 4motion	135/184	2015/05-	6MT	FD00049-RI	0A6409053AG		1
TIGUAN (5N_)	2.0 TDI 4motion	135/184	2015/05-	7AT	FD00060-RI	0A6409053AH		1
TIGUAN (5N_)	2.0 TFSI 4motion	125/170	2007/09-	6AT	FD00051-RI	0AU409053T		1
TIGUAN (5N_)	2.0 TFSI 4motion	125/170	2007/09-	6MT	FD00049-RI	0A6409053AG		1
TIGUAN (5N_)	2.0 TFSI 4motion	147/200	2007/09-2013/11	6AT	FD00051-RI	0AU409053T		1
TIGUAN (5N_)	2.0 TFSI 4motion	147/200	2007/09-	6MT	FD00049-RI	0A6409053AG		1
TIGUAN (5N_)	2.0 TFSI 4motion	147/200	2007/09-	7AT	FD00060-RI	0A6409053AH		1
TIGUAN (5N_)	2.0 TSI 4motion	132/180	2011/05-	7AT	FD00060-RI	0A6409053AH		1
TIGUAN (5N_)	2.0 TSI 4motion	132/180	2011/05-	6MT	FD00049-RI	0A6409053AG		1
TIGUAN (5N_)	2.0 TSI 4motion	132/180	2011/05-	6AT	FD00051-RI	0AU409053T		1
TIGUAN (5N_)	2.0 TSI 4motion	155/211	2011/05-	7AT	FD00060-RI	0A6409053AH		1
TIGUAN (5N_)	2.0 TSI 4motion	155/211	2011/05-	6MT	FD00049-RI	0A6409053AG		1



Img.1

### Rear Axle - Rear Differential

TIGUAN (5N_)	1.4 TSI 4motion	110/150	2007/09-	6MT	RD00058-RI	0AY525010L		1
TIGUAN (5N_)	1.4 TSI 4motion	118/160	2011/05-2013/11	6MT	RD00058-RI	0AY525010L		1

All rights reserved.

This publication may not be reproduced in any form, in whole or in part, without a written approval from S-TEC Service Technologies GmbH & Co OG.  
Subject to change without notice!

### Brand - Series - Sales Name

### Maingroup - Subgroup

Salesname	Model	kW/HP	Model Year	Gearbox	Part Number	OEM Number	Info	Image
-----------	-------	-------	------------	---------	-------------	------------	------	-------

### VW - Tiguan - TIGUAN (5N\_)

#### Rear Axle - Rear Differential

TIGUAN (5N_)	1.4 TSI 4motion	118/160	2013/11-	6MT	RD00100-RI	0AY525010N		1
TIGUAN (5N_)	2.0 TDI 4motion	100/136	2007/11-2013/11	7AT	RD00058-RI	0AY525010L		1
TIGUAN (5N_)	2.0 TDI 4motion	100/136	2007/11-2013/11	6MT	RD00058-RI	0AY525010L		1
TIGUAN (5N_)	2.0 TDI 4motion	100/136	2013/11-	7AT	RD00100-RI	0AY525010N		1
TIGUAN (5N_)	2.0 TDI 4motion	100/136	2013/11-	6MT	RD00100-RI	0AY525010N		1
TIGUAN (5N_)	2.0 TDI 4motion	103/140	2007/09-2013/11	6MT	RD00058-RI	0AY525010L		1
TIGUAN (5N_)	2.0 TDI 4motion	103/140	2007/09-2013/11	7AT	RD00058-RI	0AY525010L		1
TIGUAN (5N_)	2.0 TDI 4motion	103/140	2013/11-	7AT	RD00100-RI	0AY525010N		1
TIGUAN (5N_)	2.0 TDI 4motion	103/140	2013/11-	6MT	RD00100-RI	0AY525010N		1
TIGUAN (5N_)	2.0 TDI 4motion	110/150	2015/05-	6MT	RD00100-RI	0AY525010N		1
TIGUAN (5N_)	2.0 TDI 4motion	110/150	2015/05-	7AT	RD00100-RI	0AY525010N		1
TIGUAN (5N_)	2.0 TDI 4motion	120/163	2008/02-2009/08	6MT	RD00058-RI	0AY525010L		1
TIGUAN (5N_)	2.0 TDI 4motion	125/170	2007/09-2013/11	6AT	RD00058-RI	0AY525010L		1
TIGUAN (5N_)	2.0 TDI 4motion	125/170	2007/09-2013/11	6MT	RD00058-RI	0AY525010L		1
TIGUAN (5N_)	2.0 TDI 4motion	125/170	2013/11-	6MT	RD00100-RI	0AY525010N		1
TIGUAN (5N_)	2.0 TDI 4motion	125/170	2013/11-	6AT	RD00100-RI	0AY525010N		1
TIGUAN (5N_)	2.0 TDI 4motion	130/177	2012/11-2013/11	7AT	RD00058-RI	0AY525010L		1
TIGUAN (5N_)	2.0 TDI 4motion	130/177	2012/11-2013/11	6MT	RD00058-RI	0AY525010L		1
TIGUAN (5N_)	2.0 TDI 4motion	130/177	2013/11-	7AT	RD00100-RI	0AY525010N		1
TIGUAN (5N_)	2.0 TDI 4motion	130/177	2013/11-	6MT	RD00100-RI	0AY525010N		1
TIGUAN (5N_)	2.0 TDI 4motion	135/184	2015/05-	7AT	RD00100-RI	0AY525010N		1
TIGUAN (5N_)	2.0 TDI 4motion	135/184	2015/05-	6MT	RD00100-RI	0AY525010N		1
TIGUAN (5N_)	2.0 TFSI 4motion	125/170	2007/09-2013/11	6MT	RD00058-RI	0AY525010L		1
TIGUAN (5N_)	2.0 TFSI 4motion	125/170	2013/11-	6MT	RD00100-RI	0AY525010N		1
TIGUAN (5N_)	2.0 TFSI 4motion	147/200	2007/09-2013/11	6MT	RD00058-RI	0AY525010L		1
TIGUAN (5N_)	2.0 TFSI 4motion	147/200	2007/09-2013/11	6AT	RD00058-RI	0AY525010L		1
TIGUAN (5N_)	2.0 TFSI 4motion	147/200	2007/09-2013/11	7AT	RD00058-RI	0AY525010L		1
TIGUAN (5N_)	2.0 TFSI 4motion	147/200	2013/11-	7AT	RD00100-RI	0AY525010N		1
TIGUAN (5N_)	2.0 TFSI 4motion	147/200	2013/11-	6AT	RD00100-RI	0AY525010N		1
TIGUAN (5N_)	2.0 TFSI 4motion	147/200	2013/11-	6MT	RD00100-RI	0AY525010N		1
TIGUAN (5N_)	2.0 TSI 4motion	132/180	2011/05-2013/11	6AT	RD00058-RI	0AY525010L		1
TIGUAN (5N_)	2.0 TSI 4motion	132/180	2011/05-2013/11	6MT	RD00058-RI	0AY525010L		1
TIGUAN (5N_)	2.0 TSI 4motion	132/180	2011/05-2013/11	7AT	RD00058-RI	0AY525010L		1
TIGUAN (5N_)	2.0 TSI 4motion	132/180	2013/11-	7AT	RD00100-RI	0AY525010N		1
TIGUAN (5N_)	2.0 TSI 4motion	132/180	2013/11-	6AT	RD00100-RI	0AY525010N		1

All rights reserved.

This publication may not be reproduced in any form, in whole or in part, without a written approval from S-TEC Service Technologies GmbH & Co OG.  
Subject to change without notice!

### Brand - Series - Sales Name

### Maingroup - Subgroup

Salesname	Model	kW/HP	Model Year	Gearbox	Part Number	OEM Number	Info	Image
-----------	-------	-------	------------	---------	-------------	------------	------	-------

### VW - Tiguan - TIGUAN (5N\_)

#### Rear Axle - Rear Differential

TIGUAN (5N_)	2.0 TSI 4motion	132/180	2013/11-	6MT	RD00100-RI	0AY525010N		1
TIGUAN (5N_)	2.0 TSI 4motion	155/211	2011/05-2013/11	7AT	RD00058-RI	0AY525010L		1
TIGUAN (5N_)	2.0 TSI 4motion	155/211	2011/05-2013/11	6MT	RD00058-RI	0AY525010L		1
TIGUAN (5N_)	2.0 TSI 4motion	155/211	2013/11-	7AT	RD00100-RI	0AY525010N		1
TIGUAN (5N_)	2.0 TSI 4motion	155/211	2013/11-	6MT	RD00100-RI	0AY525010N		1

### VW - Tiguan - TIGUAN (AD1)



Img.1

#### Front Axle, Steering Unit - Power take off (PTO)

TIGUAN (AD1)	1.4 TSI 4motion	110/150	2016/05-	6DCT	FD00051-RI	0AU409053T		1
TIGUAN (AD1)	1.4 TSI 4motion	110/150	2016/05-	6MT	FD00049-RI	0A6409053AG		1
TIGUAN (AD1)	2.0 TDI 4motion	110/150	2016/01-	6MT	FD00049-RI	0A6409053AG		1



Img.1

#### Rear Axle - Rear Differential

TIGUAN (AD1)	1.4 TSI 4motion	110/150	2016/05-	6MT	RD00100-RI	0AY525010N		1
TIGUAN (AD1)	1.4 TSI 4motion	110/150	2016/05-	6DCT	RD00100-RI	0AY525010N		1
TIGUAN (AD1)	2.0 TDI 4motion	110/150	2016/01-	6MT	RD00100-RI	0AY525010N		1
TIGUAN (AD1)	2.0 TDI 4motion	110/150	2016/01-	7DCT	RD00100-RI	0AY525010N		1
TIGUAN (AD1)	2.0 TDI 4motion	130/177	2016/08-	7DCT	RD00100-RI	0AY525010N		1
TIGUAN (AD1)	2.0 TDI 4motion	140/190	2016/04-	7DCT	RD00100-RI	0AY525010N		1
TIGUAN (AD1)	2.0 TSI 4motion	132/180	2016/01-	7DCT	RD00100-RI	0AY525010N		1
TIGUAN (AD1)	2.0 TSI 4motion	132/180	2016/01-	6MT	RD00100-RI	0AY525010N		1
TIGUAN (AD1)	2.0 TSI 4motion	162/220	2016/06-	6MT	RD00100-RI	0AY525010N		1
TIGUAN (AD1)	2.0 TSI 4motion	162/220	2016/06-	7DCT	RD00100-RI	0AY525010N		1

All rights reserved.

This publication may not be reproduced in any form, in whole or in part, without a written approval from S-TEC Service Technologies GmbH & Co OG.  
Subject to change without notice!

### Brand - Series - Sales Name

### Maingroup - Subgroup

Salesname	Model	kW/HP	Model Year	Gearbox	Part Number	OEM Number	Info	Image
-----------	-------	-------	------------	---------	-------------	------------	------	-------

### VW - Touareg - TOUAREG (7LA, 7L6, 7L7)



Img.1

### Gearbox, Powertrain - Transfer Case

TOUAREG (7LA, 7L6, 7L7)	3.0 TDI	155/211	2006/04-2010/05	6AT	TC00178-RI	0AD341011L	Neck length 127,4	1
TOUAREG (7LA, 7L6, 7L7)	3.0 V6 TDI 4motion	209/284	2008/09-2010/05	6AT	TC00178-RI	0AD341011L	Neck length 127,4	1
TOUAREG (7LA, 7L6, 7L7)	3.0 V6 TDI	209/284	2008/09-2010/05	6AT	TC00178-RI	0AD341011L	Neck length 127,4	1
TOUAREG (7LA, 7L6, 7L7)	3.0 V6 TDI	165/225	2004/11-2010/05	6AT	TC00178-RI	0AD341011L	Neck length 127,4	1
TOUAREG (7LA, 7L6, 7L7)	3.0 V6 TDI	176/240	2007/11-2010/05	6AT	TC00178-RI	0AD341011L	Neck length 127,4	1
TOUAREG (7LA, 7L6, 7L7)	3.2 V6	162/220	2002/10-2006/11	6AT	TC00180-RI	0AD341011N	Neck length 158,2	1
TOUAREG (7LA, 7L6, 7L7)	3.2 V6	177/241	2004/11-2006/11	6AT	TC00178-RI	0AD341011L	Neck length 127,4	1
TOUAREG (7LA, 7L6, 7L7)	3.6 V6 FSI	206/280	2005/10-2010/05	6AT	TC00180-RI	0AD341011N	Neck length 158,2	1
TOUAREG (7LA, 7L6, 7L7)	4.2 FSI	231/314	2007/09-2009/12	6AT	TC00178-RI	0AD341011L	Neck length 127,4	1
TOUAREG (7LA, 7L6, 7L7)	4.2 V8 FSI	257/350	2006/06-2010/05	6AT	TC00178-RI	0AD341011L	Neck length 127,4	1
TOUAREG (7LA, 7L6, 7L7)	5.0 R50 TDI	257/350	2007/08-2010/05	6AT	TC00178-RI	0AD341011L	Neck length 127,4	1
TOUAREG (7LA, 7L6, 7L7)	5.0 TDI V10	230/313	2002/11-2004/01	6AT	TC00178-RI	0AD341011L	Neck length 127,4	1
TOUAREG (7LA, 7L6, 7L7)	5.0 V10 TDI	230/313	2002/10-2010/05	6AT	TC00178-RI	0AD341011L	Neck length 127,4	1

### VW - Touareg - TOUAREG (7P5)



Img.1



Img.2



Img.3



Img.4



Img.5

### Gearbox, Powertrain - Transfer Case

TOUAREG (7P5)	3.0 V6 TDI	150/204	2010/09-	8AT	TC00311-RI	0BU341011Q; 95834102003	Neck length: 127,4 ; with differential lock	1
TOUAREG (7P5)	3.0 V6 TDI	165/224	2010/06-	8AT	TC00311-RI	0BU341011Q; 95834102003	Neck length: 127,4 ; with differential lock	1
TOUAREG (7P5)	3.0 V6 TDI	176/239	2010/02-2011/04	8AT	TC00311-RI	0BU341011Q; 95834102003	Neck length: 127,4 ; with differential lock	1
TOUAREG (7P5)	3.0 V6 TDI	180/245	2011/05-	8AT	TC00311-RI	0BU341011Q; 95834102003	Neck length: 127,4 ; with differential lock	1
TOUAREG (7P5)	3.0 V6 TSI China	245/333	2010/08-	8DCT	TC00319-RI	0BU341011T; 95834102021	Neck length: 191,2	2
TOUAREG (7P5)	3.0 V6 TSI Hybrid	245/333	2010/02-	8AT	TC00323-RI	0BU341011M; 95834102012	Neck length: 41,3 ; with differential lock	3
TOUAREG (7P5)	3.6 V6 FSI	206/280	2010/05-2013/04	8AT	TC00314-RI	0BU341011R	Neck length: 155,7 ; with differential lock	4
TOUAREG (7P5)	4.2 V8 TDI	250/340	2013/01-	8AT	TC00304-RI	0BU341010P	Neck length: 155,7 ; with differential lock	5

All rights reserved.

This publication may not be reproduced in any form, in whole or in part, without a written approval from S-TEC Service Technologies GmbH & Co OG.  
Subject to change without notice!

### Brand - Series - Sales Name

### Maingroup - Subgroup

Salesname	Model	kW/HP	Model Year	Gearbox	Part Number	OEM Number	Info	Image
-----------	-------	-------	------------	---------	-------------	------------	------	-------

### VW - Touareg - TOUAREG (7P5, 7P6)



Img.1



Img.2



Img.3



Img.4



Img.5



Img.6



Img.7

### Gearbox, Powertrain - Transfer Case

TOUAREG (7P5, 7P6)	3.0 V6 TDI	150/204	2010/01-	8AT	TC00297-RI	0BV341010K	Neck length: 127,4	1
TOUAREG (7P5, 7P6)	3.0 V6 TDI	150/204	2010/01-	8AT	TC00311-RI	0BU341011Q; 95834102003	Neck length 127,4	2
TOUAREG (7P5, 7P6)	3.0 V6 TDI	165/225	2010/06-	8AT	TC00311-RI	0BU341011Q; 95834102003	Neck length 127,4	2
TOUAREG (7P5, 7P6)	3.0 V6 TDI	165/225	2010/06-	8AT	TC00297-RI	0BV341010K	Neck length: 127,4	1
TOUAREG (7P5, 7P6)	3.0 V6 TDI	176/240	2010/01-	8AT	TC00297-RI	0BV341010K	Neck length: 127,4	1
TOUAREG (7P5, 7P6)	3.0 V6 TDI	176/240	2010/01-	8AT	TC00311-RI	0BU341011Q; 95834102003	Neck length 127,4	2
TOUAREG (7P5, 7P6)	3.0 V6 TDI	180/245	2011/05-	8AT	TC00297-RI	0BV341010K	Neck length: 127,4	1
TOUAREG (7P5, 7P6)	3.0 V6 TDI	180/245	2011/05-	8AT	TC00311-RI	0BU341011Q; 95834102003	Neck length 127,4	2
TOUAREG (7P5, 7P6)	3.0 V6 TDI	193/262	2014/09-	8AT	TC00311-RI	0BU341011Q; 95834102003	Neck length 127,4	2
TOUAREG (7P5, 7P6)	3.0 V6 TDI	209/284	2010/09-	8AT	TC00311-RI	0BU341011Q; 95834102003	Neck length 127,4	2
TOUAREG (7P5, 7P6)	3.0 V6 TDI	209/284	2010/09-	8AT	TC00297-RI	0BV341010K	Neck length: 127,4	1
TOUAREG (7P5, 7P6)	3.0 V6 TSI Hybrid	245/333	2010/04-	8AT	TC00323-RI	0BU341011M; 95834102012	Neck length 41,3	3
TOUAREG (7P5, 7P6)	3.0 V6 TSI Hybrid	283/385	2010/09-	8AT	TC00323-RI	0BU341011M; 95834102012	Neck length 41,3	3
TOUAREG (7P5, 7P6)	3.0 V6 TSI	213/290	2010/08-	8AT	TC00323-RI	0BU341011M; 95834102012	Neck length 41,3	3
TOUAREG (7P5, 7P6)	3.0 V6 TSI	235/320	2015/01-	8AT	TC00297-RI	0BV341010K	Neck length: 127,4	1
TOUAREG (7P5, 7P6)	3.0 V6 TSI	235/320	2015/01-	8AT	TC00319-RI	0BU341011T; 95834102021	Neck length 191,2	4
TOUAREG (7P5, 7P6)	3.6 V6 FSI	183/249	2010/08-	8AT	TC00297-RI	0BV341010K	Neck length: 127,4	1
TOUAREG (7P5, 7P6)	3.6 V6 FSI	183/249	2010/08-	8AT	TC00314-RI	0BU341011R	Neck length 155,7	5
TOUAREG (7P5, 7P6)	3.6 V6 FSI	206/280	2010/04-	8AT	TC00297-RI	0BV341010K	Neck length: 127,4	1
TOUAREG (7P5, 7P6)	3.6 V6 FSI	206/280	2010/04-	8AT	TC00314-RI	0BU341011R	Neck length 155,7	5
TOUAREG (7P5, 7P6)	4.2 V8 FSI	265/360	2011/01-	8AT	TC00328-RI	0BU341011S	Neck length 155,7	5
TOUAREG (7P5, 7P6)	4.2 V8 TDI	250/340	2010/01-	8AT	TC00304-RI	0BU341010P	Neck length 155,7	6
TOUAREG (7P5, 7P6)	4.2 V8 TDI	250/340	2010/01-	8AT	TC00326-RI	0BU341011F	Neck length 155,7	7

All rights reserved.

This publication may not be reproduced in any form, in whole or in part, without a written approval from S-TEC Service Technologies GmbH & Co OG.  
Subject to change without notice!



### Brand - Series - Sales Name

### Maingroup - Subgroup

Salesname	Model	kW/HP	Model Year	Gearbox	Part Number	OEM Number	Info	Image
-----------	-------	-------	------------	---------	-------------	------------	------	-------

### VW - Transporter - MULTIVAN V (7HM, 7HN, 7HF, 7EF, 7EM, 7EN)



Img.1

### Front Axle, Steering Unit - Power take off (PTO)

MULTIVAN V (7HM, 7HN, 7HF, 7EF, 7EM, 7EN)	2.0 BiTDI 4motion	132/180	2009/09-2015/08	7AT	FD00058-RI	09N409053E	Automatic transmission	1
MULTIVAN V (7HM, 7HN, 7HF, 7EF, 7EM, 7EN)	2.0 TSI 4motion	150/204	2011/07-2015/08	7AT	FD00058-RI	09N409053E	Automatic transmission	1



Img.1

### Rear Axle - Rear Differential

MULTIVAN V (7HM, 7HN, 7HF, 7EF, 7EM, 7EN)	2.0 BiTDI 4motion	132/180	2009/09-2015/08	7AT	RD00025-RI	09N525010C	Without differential lock	
MULTIVAN V (7HM, 7HN, 7HF, 7EF, 7EM, 7EN)	2.0 BiTDI 4motion	132/180	2009/09-2015/08	7AT	RD00028-RI	09N525010E	With differential lock	
MULTIVAN V (7HM, 7HN, 7HF, 7EF, 7EM, 7EN)	2.0 TDI 4motion	100/136	2010/05-2015/08	6MT	RD00025-RI	09N525010C	Without differential lock	
MULTIVAN V (7HM, 7HN, 7HF, 7EF, 7EM, 7EN)	2.0 TDI 4motion	100/136	2010/05-2015/08	6MT	RD00028-RI	09N525010E	With differential lock	
MULTIVAN V (7HM, 7HN, 7HF, 7EF, 7EM, 7EN)	2.0 TDI 4motion	103/140	2009/09-2015/08	6MT	RD00028-RI	09N525010E	With differential lock	
MULTIVAN V (7HM, 7HN, 7HF, 7EF, 7EM, 7EN)	2.0 TDI 4motion	103/140	2009/09-2015/08	6MT	RD00025-RI	09N525010C	Without differential lock	
MULTIVAN V (7HM, 7HN, 7HF, 7EF, 7EM, 7EN)	2.0 TSI 4motion	150/204	2011/07-2015/08	7AT	RD00025-RI	09N525010C	Without differential lock	
MULTIVAN V (7HM, 7HN, 7HF, 7EF, 7EM, 7EN)	2.0 TSI 4motion	150/204	2011/07-2015/08	7AT	RD00028-RI	09N525010E	With differential lock	
MULTIVAN V (7HM, 7HN, 7HF, 7EF, 7EM, 7EN)	2.5 TDI 4motion	128/174	2004/07-2009/11	6MT	RD00062-RI	02W525010K	With differential lock	1
MULTIVAN V (7HM, 7HN, 7HF, 7EF, 7EM, 7EN)	2.5 TDI 4motion	128/174	2004/07-2009/11	6MT	RD00063-RI	02W525010L	Without differential lock	1
MULTIVAN V (7HM, 7HN, 7HF, 7EF, 7EM, 7EN)	2.5 TDI 4motion	96/130	2004/07-2009/11	6MT	RD00063-RI	02W525010L	Without differential lock	1
MULTIVAN V (7HM, 7HN, 7HF, 7EF, 7EM, 7EN)	2.5 TDI 4motion	96/130	2004/07-2009/11	6MT	RD00062-RI	02W525010K	With differential lock	1
MULTIVAN V (7HM, 7HN, 7HF, 7EF, 7EM, 7EN)	3.2 V6 4motion	173/235	2004/07-2009/11	6MT	RD00063-RI	02W525010L	Without differential lock	1

All rights reserved.

This publication may not be reproduced in any form, in whole or in part, without a written approval from S-TEC Service Technologies GmbH & Co OG.  
Subject to change without notice!

### Brand - Series - Sales Name

### Maingroup - Subgroup

Salesname	Model	kW/HP	Model Year	Gearbox	Part Number	OEM Number	Info	Image
-----------	-------	-------	------------	---------	-------------	------------	------	-------

### VW - Transporter - MULTIVAN V (7HM, 7HN, 7HF, 7EF, 7EM, 7EN)

#### Rear Axle - Rear Differential

MULTIVAN V (7HM, 7HN, 7HF, 7EF, 7EM, 7EN)	3.2 V6 4motion	173/235	2004/07-2009/11	6MT	RD00062-RI	02W525010K	With differential lock	1
---	----------------	---------	-----------------	-----	------------	------------	------------------------	---

### VW - Transporter - MULTIVAN VI (SGF, SGM, SGN)



Img.1

#### Front Axle, Steering Unit - Power take off (PTO)

MULTIVAN VI (SGF, SGM, SGN)	2.0 TDI 4motion	103/140	2015/06-	6MT	FD00059-RI	09N409053D	Manual transmission	1
MULTIVAN VI (SGF, SGM, SGN)	2.0 TDI 4motion	110/150	2015/08-	7DCT	FD00058-RI	09N409053E	Automatic transmission	1
MULTIVAN VI (SGF, SGM, SGN)	2.0 TDI 4motion	110/150	2015/08-	6MT	FD00059-RI	09N409053D	Manual transmission	1
MULTIVAN VI (SGF, SGM, SGN)	2.0 TDI 4motion	132/180	2015/06-	7DCT	FD00058-RI	09N409053E	Automatic transmission	1
MULTIVAN VI (SGF, SGM, SGN)	2.0 TDI 4motion	150/204	2015/06-	7DCT	FD00058-RI	09N409053E	Automatic transmission	1
MULTIVAN VI (SGF, SGM, SGN)	2.0 TSI 4motion	150/204	2015/06-	7DCT	FD00058-RI	09N409053E	Automatic transmission	1

All rights reserved.

This publication may not be reproduced in any form, in whole or in part, without a written approval from S-TEC Service Technologies GmbH & Co OG.  
Subject to change without notice!

### Brand - Series - Sales Name

### Maingroup - Subgroup

Salesname	Model	kW/HP	Model Year	Gearbox	Part Number	OEM Number	Info	Image
-----------	-------	-------	------------	---------	-------------	------------	------	-------

### VW - Transporter - TRANSPORTER V Flat bed truck (7JD, 7JE, 7JL, 7JY, 7JZ)



Img.1

### Front Axle, Steering Unit - Power take off (PTO)

TRANSPORTER V Flat bed truck (7JD, 7JE, 7JL, 7JY, 7JZ)	2.0 BiTDI 4motion	132/180	2009/09-2015/08	6MT	FD00059-RI	09N409053D	Manual transmission	1
TRANSPORTER V Flat bed truck (7JD, 7JE, 7JL, 7JY, 7JZ)	2.0 TDI 4motion	100/136	2010/05-2015/08	6MT	FD00059-RI	09N409053D	Manual transmission	1
TRANSPORTER V Flat bed truck (7JD, 7JE, 7JL, 7JY, 7JZ)	2.0 TDI 4motion	103/140	2009/09-2015/08	6MT	FD00059-RI	09N409053D	Manual transmission	1



Img.1

### Rear Axle - Rear Differential

TRANSPORTER V Flat bed truck (7JD, 7JE, 7JL, 7JY, 7JZ)	2.0 BiTDI 4motion	132/180	2009/09-2015/08	6MT	RD00025-RI	09N525010C	Without differential lock	
TRANSPORTER V Flat bed truck (7JD, 7JE, 7JL, 7JY, 7JZ)	2.0 BiTDI 4motion	132/180	2009/09-2015/08	6MT	RD00028-RI	09N525010E	With differential lock	
TRANSPORTER V Flat bed truck (7JD, 7JE, 7JL, 7JY, 7JZ)	2.0 TDI 4motion	100/136	2010/05-2015/08	6MT	RD00025-RI	09N525010C	Without differential lock	
TRANSPORTER V Flat bed truck (7JD, 7JE, 7JL, 7JY, 7JZ)	2.0 TDI 4motion	100/136	2010/05-2015/08	6MT	RD00028-RI	09N525010E	With differential lock	
TRANSPORTER V Flat bed truck (7JD, 7JE, 7JL, 7JY, 7JZ)	2.0 TDI 4motion	103/140	2009/09-2015/08	6MT	RD00028-RI	09N525010E	With differential lock	
TRANSPORTER V Flat bed truck (7JD, 7JE, 7JL, 7JY, 7JZ)	2.0 TDI 4motion	103/140	2009/09-2015/08	6MT	RD00025-RI	09N525010C	Without differential lock	
TRANSPORTER V Flat bed truck (7JD, 7JE, 7JL, 7JY, 7JZ)	2.5 TDI 4motion	128/174	2004/04-2009/11	6MT	RD00063-RI	02W525010L	Without differential lock	1
TRANSPORTER V Flat bed truck (7JD, 7JE, 7JL, 7JY, 7JZ)	2.5 TDI 4motion	128/174	2004/04-2009/11	6MT	RD00062-RI	02W525010K	With differential lock	1

All rights reserved.

This publication may not be reproduced in any form, in whole or in part, without a written approval from S-TEC Service Technologies GmbH & Co OG.  
Subject to change without notice!

### Brand - Series - Sales Name

### Maingroup - Subgroup

Salesname	Model	kW/HP	Model Year	Gearbox	Part Number	OEM Number	Info	Image
-----------	-------	-------	------------	---------	-------------	------------	------	-------

### VW - Transporter - TRANSPORTER V Flat bed truck (7JD, 7JE, 7JL, 7JY, 7JZ)

#### Rear Axle - Rear Differential

TRANSPORTER V Flat bed truck (7JD, 7JE, 7JL, 7JY, 7JZ)	2.5 TDI 4motion	96/130	2004/07-2009/11	6MT	RD00063-RI	02W525010L	Without differential lock	1
TRANSPORTER V Flat bed truck (7JD, 7JE, 7JL, 7JY, 7JZ)	2.5 TDI 4motion	96/130	2004/07-2009/11	6MT	RD00062-RI	02W525010K	With differential lock	1
TRANSPORTER V Flat bed truck (7JD, 7JE, 7JL, 7JY, 7JZ)	3.2 4motion	170/231	2003/11-2009/11	6MT	RD00063-RI	02W525010L	Without differential lock	1
TRANSPORTER V Flat bed truck (7JD, 7JE, 7JL, 7JY, 7JZ)	3.2 4motion	170/231	2003/11-2009/11	6MT	RD00062-RI	02W525010K	With differential lock	1

All rights reserved.

This publication may not be reproduced in any form, in whole or in part, without a written approval from S-TEC Service Technologies GmbH & Co OG.  
Subject to change without notice!

### Brand - Series - Sales Name

### Maingroup - Subgroup

Salesname	Model	kW/HP	Model Year	Gearbox	Part Number	OEM Number	Info	Image
-----------	-------	-------	------------	---------	-------------	------------	------	-------

### VW - Transporter - TRANSPORTER V Flat bed truck (7JD, 7JE, 7JL, 7JY, 7JZ)



Img.1

#### Front Axle, Steering Unit - Power take off (PTO)

TRANSPORTER V Flat bed truck (7JD, 7JE, 7JL, 7JY, 7JZ)	2.0 BiTDI 4motion	132/180	2009/09-2015/08	6MT	FD00059-RI	09N409053D	Manual transmission	1
TRANSPORTER V Flat bed truck (7JD, 7JE, 7JL, 7JY, 7JZ)	2.0 TDI 4motion	100/136	2010/05-2015/08	6MT	FD00059-RI	09N409053D	Manual transmission	1
TRANSPORTER V Flat bed truck (7JD, 7JE, 7JL, 7JY, 7JZ)	2.0 TDI 4motion	103/140	2009/09-2015/08	6MT	FD00059-RI	09N409053D	Manual transmission	1



Img.1

#### Rear Axle - Rear Differential

TRANSPORTER V Flat bed truck (7JD, 7JE, 7JL, 7JY, 7JZ)	2.0 BiTDI 4motion	132/180	2009/09-2015/08	6MT	RD00028-RI	09N525010E	With differential lock	
TRANSPORTER V Flat bed truck (7JD, 7JE, 7JL, 7JY, 7JZ)	2.0 BiTDI 4motion	132/180	2009/09-2015/08	6MT	RD00025-RI	09N525010C	Without differential lock	
TRANSPORTER V Flat bed truck (7JD, 7JE, 7JL, 7JY, 7JZ)	2.0 TDI 4motion	100/136	2010/05-2015/08	6MT	RD00025-RI	09N525010C	Without differential lock	
TRANSPORTER V Flat bed truck (7JD, 7JE, 7JL, 7JY, 7JZ)	2.0 TDI 4motion	100/136	2010/05-2015/08	6MT	RD00028-RI	09N525010E	With differential lock	
TRANSPORTER V Flat bed truck (7JD, 7JE, 7JL, 7JY, 7JZ)	2.0 TDI 4motion	103/140	2009/09-2015/08	6MT	RD00025-RI	09N525010C	Without differential lock	
TRANSPORTER V Flat bed truck (7JD, 7JE, 7JL, 7JY, 7JZ)	2.0 TDI 4motion	103/140	2009/09-2015/08	6MT	RD00028-RI	09N525010E	With differential lock	
TRANSPORTER V Flat bed truck (7JD, 7JE, 7JL, 7JY, 7JZ)	2.5 TDI 4motion	128/174	2004/04-2009/11	6MT	RD00063-RI	02W525010L	Without differential lock	1
TRANSPORTER V Flat bed truck (7JD, 7JE, 7JL, 7JY, 7JZ)	2.5 TDI 4motion	96/130	2004/07-2009/11	6MT	RD00063-RI	02W525010L	Without differential lock	1

All rights reserved.

This publication may not be reproduced in any form, in whole or in part, without a written approval from S-TEC Service Technologies GmbH & Co OG.  
Subject to change without notice!

### Brand - Series - Sales Name

### Maingroup - Subgroup

Salesname	Model	kW/HP	Model Year	Gearbox	Part Number	OEM Number	Info	Image
-----------	-------	-------	------------	---------	-------------	------------	------	-------

### VW - Transporter - TRANSPORTER V Flat bed truck (7JD, 7JE, 7JL, 7JY, 7JZ)

#### Rear Axle - Rear Differential

TRANSPORTER V Flat bed truck (7JD, 7JE, 7JL, 7JY, 7JZ)	3.2 4motion	170/231	2003/11-2009/11	6MT	RD00063-RI	02W525010L	Without differential lock	1
TRANSPORTER V Flat bed truck (7JD, 7JE, 7JL, 7JY, 7JZ)	3.2 4motion	170/231	2003/11-2009/11	6MT	RD00062-RI	02W525010K	With differential lock	1

All rights reserved.

This publication may not be reproduced in any form, in whole or in part, without a written approval from S-TEC Service Technologies GmbH & Co OG.  
Subject to change without notice!

### Brand - Series - Sales Name

### Maingroup - Subgroup

Salesname	Model	kW/HP	Model Year	Gearbox	Part Number	OEM Number	Info	Image
-----------	-------	-------	------------	---------	-------------	------------	------	-------

### VW - Transporter - TRANSPORTER V Full size van (7HA, 7HH, 7EA, 7EH)



Img.1

### Front Axle, Steering Unit - Power take off (PTO)

TRANSPORTER V Full size van (7HA, 7HH, 7EA, 7EH)	2.0 BiTDI 4motion	132/180	2009/09-2015/08	7AT	FD00058-RI	09N409053E	Automatic transmission	1
TRANSPORTER V Full size van (7HA, 7HH, 7EA, 7EH)	2.0 BiTDI 4motion	132/180	2009/09-2015/08	6MT	FD00059-RI	09N409053D	Manual transmission	1
TRANSPORTER V Full size van (7HA, 7HH, 7EA, 7EH)	2.0 TDI 4motion	100/136	2010/05-2015/08	6MT	FD00059-RI	09N409053D	Manual transmission	1
TRANSPORTER V Full size van (7HA, 7HH, 7EA, 7EH)	2.0 TDI 4motion	103/140	2009/09-2015/08	6MT	FD00059-RI	09N409053D	Manual transmission	1
TRANSPORTER V Full size van (7HA, 7HH, 7EA, 7EH)	2.0 TSI 4motion	150/204	2011/07-2015/08	7AT	FD00058-RI	09N409053E	Automatic transmission	1



Img.1

### Rear Axle - Rear Differential

TRANSPORTER V Full size van (7HA, 7HH, 7EA, 7EH)	2.0 BiTDI 4motion	132/180	2009/09-2015/08	7AT	RD00028-RI	09N525010E	With differential lock	
TRANSPORTER V Full size van (7HA, 7HH, 7EA, 7EH)	2.0 BiTDI 4motion	132/180	2009/09-2015/08	7AT	RD00025-RI	09N525010C	Without differential lock	
TRANSPORTER V Full size van (7HA, 7HH, 7EA, 7EH)	2.0 BiTDI 4motion	132/180	2009/09-2015/08	6MT	RD00025-RI	09N525010C	Without differential lock	
TRANSPORTER V Full size van (7HA, 7HH, 7EA, 7EH)	2.0 BiTDI 4motion	132/180	2009/09-2015/08	6MT	RD00028-RI	09N525010E	With differential lock	
TRANSPORTER V Full size van (7HA, 7HH, 7EA, 7EH)	2.0 TDI 4motion	100/136	2010/05-2015/08	6MT	RD00028-RI	09N525010E	With differential lock	
TRANSPORTER V Full size van (7HA, 7HH, 7EA, 7EH)	2.0 TDI 4motion	100/136	2010/05-2015/08	6MT	RD00025-RI	09N525010C	Without differential lock	

All rights reserved.

This publication may not be reproduced in any form, in whole or in part, without a written approval from S-TEC Service Technologies GmbH & Co OG.  
Subject to change without notice!

### Brand - Series - Sales Name

### Maingroup - Subgroup

Salesname	Model	kW/HP	Model Year	Gearbox	Part Number	OEM Number	Info	Image
-----------	-------	-------	------------	---------	-------------	------------	------	-------

### VW - Transporter - TRANSPORTER V Full size van (7HA, 7HH, 7EA, 7EH)

#### Rear Axle - Rear Differential

TRANSPORTER V Full size van (7HA, 7HH, 7EA, 7EH)	2.0 TDI 4motion	103/140	2009/09-2015/08	6MT	RD00028-RI	09N525010E	With differential lock	
TRANSPORTER V Full size van (7HA, 7HH, 7EA, 7EH)	2.0 TDI 4motion	103/140	2009/09-2015/08	6MT	RD00025-RI	09N525010C	Without differential lock	
TRANSPORTER V Full size van (7HA, 7HH, 7EA, 7EH)	2.0 TSI 4motion	150/204	2011/07-2015/08	7AT	RD00025-RI	09N525010C	Without differential lock	
TRANSPORTER V Full size van (7HA, 7HH, 7EA, 7EH)	2.5 TDI 4motion	128/174	2004/07-2009/11	6MT	RD00063-RI	02W525010L	Without differential lock	1
TRANSPORTER V Full size van (7HA, 7HH, 7EA, 7EH)	2.5 TDI 4motion	128/174	2004/07-2009/11	6MT	RD00062-RI	02W525010K	With differential lock	1
TRANSPORTER V Full size van (7HA, 7HH, 7EA, 7EH)	2.5 TDI 4motion	96/130	2004/07-2009/11	6MT	RD00063-RI	02W525010L	Without differential lock	1
TRANSPORTER V Full size van (7HA, 7HH, 7EA, 7EH)	2.5 TDI 4motion	96/130	2004/07-2009/11	6MT	RD00062-RI	02W525010K	With differential lock	1
TRANSPORTER V Full size van (7HA, 7HH, 7EA, 7EH)	3.2 4motion	173/235	2003/11-2009/11	6MT	RD00063-RI	02W525010L	Without differential lock	1
TRANSPORTER V Full size van (7HA, 7HH, 7EA, 7EH)	3.2 4motion	173/235	2003/11-2009/11	6MT	RD00062-RI	02W525010K	With differential lock	1

All rights reserved.

This publication may not be reproduced in any form, in whole or in part, without a written approval from S-TEC Service Technologies GmbH & Co OG.  
Subject to change without notice!



### Brand - Series - Sales Name

### Maingroup - Subgroup

Salesname	Model	kW/HP	Model Year	Gearbox	Part Number	OEM Number	Info	Image
-----------	-------	-------	------------	---------	-------------	------------	------	-------

### VW - Transporter - TRANSPORTER V Minibus (7HB, 7HJ, 7EB, 7EJ, 7EF, 7EG, 7HF, 7EC)



Img.1

### Front Axle, Steering Unit - Power take off (PTO)

TRANSPORTER V Minibus (7HB, 7HJ, 7EB, 7EJ, 7EF, 7EG, 7HF, 7EC)	2.0 BiTDI 4motion	132/180	2009/09-2015/08	7AT	FD00058-RI	09N409053E	Automatic transmission	1
TRANSPORTER V Minibus (7HB, 7HJ, 7EB, 7EJ, 7EF, 7EG, 7HF, 7EC)	2.0 BiTDI 4motion	132/180	2009/09-2015/08	6MT	FD00059-RI	09N409053D	Manual transmission	1
TRANSPORTER V Minibus (7HB, 7HJ, 7EB, 7EJ, 7EF, 7EG, 7HF, 7EC)	2.0 TDI 4motion	100/136	2010/05-2015/08	6MT	FD00059-RI	09N409053D	Manual transmission	1
TRANSPORTER V Minibus (7HB, 7HJ, 7EB, 7EJ, 7EF, 7EG, 7HF, 7EC)	2.0 TDI 4motion	103/140	2009/09-2015/08	6MT	FD00059-RI	09N409053D	Manual transmission	1
TRANSPORTER V Minibus (7HB, 7HJ, 7EB, 7EJ, 7EF, 7EG, 7HF, 7EC)	2.0 TSI 4motion	150/204	2011/07-2015/08	7AT	FD00058-RI	09N409053E	Automatic transmission	1



Img.1

### Rear Axle - Rear Differential

TRANSPORTER V Minibus (7HB, 7HJ, 7EB, 7EJ, 7EF, 7EG, 7HF, 7EC)	2.0 BiTDI 4motion	132/180	2009/09-2015/08	6MT	RD00025-RI	09N525010C	Without differential lock	
TRANSPORTER V Minibus (7HB, 7HJ, 7EB, 7EJ, 7EF, 7EG, 7HF, 7EC)	2.0 BiTDI 4motion	132/180	2009/09-2015/08	6MT	RD00028-RI	09N525010E	With differential lock	
TRANSPORTER V Minibus (7HB, 7HJ, 7EB, 7EJ, 7EF, 7EG, 7HF, 7EC)	2.0 BiTDI 4motion	132/180	2009/09-2015/08	7AT	RD00025-RI	09N525010C	Without differential lock	
TRANSPORTER V Minibus (7HB, 7HJ, 7EB, 7EJ, 7EF, 7EG, 7HF, 7EC)	2.0 BiTDI 4motion	132/180	2009/09-2015/08	7AT	RD00028-RI	09N525010E	With differential lock	

All rights reserved.

This publication may not be reproduced in any form, in whole or in part, without a written approval from S-TEC Service Technologies GmbH & Co OG.  
Subject to change without notice!

### Brand - Series - Sales Name

### Maingroup - Subgroup

Salesname	Model	kW/HP	Model Year	Gearbox	Part Number	OEM Number	Info	Image
-----------	-------	-------	------------	---------	-------------	------------	------	-------

### VW - Transporter - TRANSPORTER V Minibus (7HB, 7HJ, 7EB, 7EJ, 7EF, 7EG, 7HF, 7EC)

#### Rear Axle - Rear Differential

TRANSPORTER V Minibus (7HB, 7HJ, 7EB, 7EJ, 7EF, 7EG, 7HF, 7EC)	2.0 TDI 4motion	100/136	2010/05-2015/08	6MT	RD00028-RI	09N525010E	With differential lock	
TRANSPORTER V Minibus (7HB, 7HJ, 7EB, 7EJ, 7EF, 7EG, 7HF, 7EC)	2.0 TDI 4motion	100/136	2010/05-2015/08	6MT	RD00025-RI	09N525010C	Without differential lock	
TRANSPORTER V Minibus (7HB, 7HJ, 7EB, 7EJ, 7EF, 7EG, 7HF, 7EC)	2.0 TDI 4motion	103/140	2009/09-2015/08	6MT	RD00028-RI	09N525010E	With differential lock	
TRANSPORTER V Minibus (7HB, 7HJ, 7EB, 7EJ, 7EF, 7EG, 7HF, 7EC)	2.0 TDI 4motion	103/140	2009/09-2015/08	6MT	RD00025-RI	09N525010C	Without differential lock	
TRANSPORTER V Minibus (7HB, 7HJ, 7EB, 7EJ, 7EF, 7EG, 7HF, 7EC)	2.0 TSI 4motion	150/204	2011/07-2015/08	7AT	RD00025-RI	09N525010C	Without differential lock	
TRANSPORTER V Minibus (7HB, 7HJ, 7EB, 7EJ, 7EF, 7EG, 7HF, 7EC)	2.0 TSI 4motion	150/204	2011/07-2015/08	7AT	RD00028-RI	09N525010E	With differential lock	
TRANSPORTER V Minibus (7HB, 7HJ, 7EB, 7EJ, 7EF, 7EG, 7HF, 7EC)	2.5 TDI 4motion	128/174	2004/07-2009/11	6MT	RD00062-RI	02W525010K	With differential lock	1
TRANSPORTER V Minibus (7HB, 7HJ, 7EB, 7EJ, 7EF, 7EG, 7HF, 7EC)	2.5 TDI 4motion	128/174	2004/07-2009/11	6MT	RD00063-RI	02W525010L	Without differential lock	1
TRANSPORTER V Minibus (7HB, 7HJ, 7EB, 7EJ, 7EF, 7EG, 7HF, 7EC)	2.5 TDI 4motion	96/130	2004/07-2009/11	6MT	RD00062-RI	02W525010K	With differential lock	1
TRANSPORTER V Minibus (7HB, 7HJ, 7EB, 7EJ, 7EF, 7EG, 7HF, 7EC)	2.5 TDI 4motion	96/130	2004/07-2009/11	6MT	RD00063-RI	02W525010L	Without differential lock	1
TRANSPORTER V Minibus (7HB, 7HJ, 7EB, 7EJ, 7EF, 7EG, 7HF, 7EC)	3.2 V6 4motion	173/235	2003/11-2009/11	6MT	RD00063-RI	02W525010L	Without differential lock	1
TRANSPORTER V Minibus (7HB, 7HJ, 7EB, 7EJ, 7EF, 7EG, 7HF, 7EC)	3.2 V6 4motion	173/235	2003/11-2009/11	6MT	RD00062-RI	02W525010K	With differential lock	1

All rights reserved.

This publication may not be reproduced in any form, in whole or in part, without a written approval from S-TEC Service Technologies GmbH & Co OG.  
Subject to change without notice!

### Brand - Series - Sales Name

### Maingroup - Subgroup

Salesname	Model	kW/HP	Model Year	Gearbox	Part Number	OEM Number	Info	Image
-----------	-------	-------	------------	---------	-------------	------------	------	-------

### VW - Transporter - TRANSPORTER VI Flat bed truck (SFD, SFE, SFL, SFZ)



Img.1

#### Front Axle, Steering Unit - Power take off (PTO)

TRANSPORTER VI Flat bed truck (SFD, SFE, SFL, SFZ)	2.0 TDI 4motion	103/140	2015/06-	6MT	FD00059-RI	09N409053D	Manual transmission	1
TRANSPORTER VI Flat bed truck (SFD, SFE, SFL, SFZ)	2.0 TDI 4motion	110/150	2016/05-	6MT	FD00059-RI	09N409053D	Manual transmission	1
TRANSPORTER VI Flat bed truck (SFD, SFE, SFL, SFZ)	2.0 TDI 4motion	132/180	2015/06-	6MT	FD00059-RI	09N409053D	Manual transmission	1
TRANSPORTER VI Flat bed truck (SFD, SFE, SFL, SFZ)	2.0 TDI 4motion	150/204	2016/05-	7DCT	FD00058-RI	09N409053E	Automatic transmission	1

### VW - Transporter - TRANSPORTER VI Full size van (SGA, SGH)



Img.1

#### Front Axle, Steering Unit - Power take off (PTO)

TRANSPORTER VI Full size van (SGA, SGH)	2.0 TDI 4motion	103/140	2015/06-	6MT	FD00059-RI	09N409053D	Manual transmission	1
TRANSPORTER VI Full size van (SGA, SGH)	2.0 TDI 4motion	110/150	2015/08-	7DCT	FD00058-RI	09N409053E	Automatic transmission	1
TRANSPORTER VI Full size van (SGA, SGH)	2.0 TDI 4motion	110/150	2015/08-	6MT	FD00059-RI	09N409053D	Manual transmission	1
TRANSPORTER VI Full size van (SGA, SGH)	2.0 TDI 4motion	132/180	2015/06-	6MT	FD00059-RI	09N409053D	Manual transmission	1
TRANSPORTER VI Full size van (SGA, SGH)	2.0 TDI 4motion	150/204	2015/06-	7DCT	FD00058-RI	09N409053E	Automatic transmission	1
TRANSPORTER VI Full size van (SGA, SGH)	2.0 TSI 4motion	150/204	2015/06-	7DCT	FD00058-RI	09N409053E	Automatic transmission	1

All rights reserved.

This publication may not be reproduced in any form, in whole or in part, without a written approval from S-TEC Service Technologies GmbH & Co OG. Subject to change without notice!

### Brand - Series - Sales Name

### Maingroup - Subgroup

Salesname	Model	kW/HP	Model Year	Gearbox	Part Number	OEM Number	Info	Image
-----------	-------	-------	------------	---------	-------------	------------	------	-------

### VW - Transporter - TRANSPORTER VI Minibus (SGB, SGG, SGJ)



Img.1

### Front Axle, Steering Unit - Power take off (PTO)

TRANSPORTER VI Minibus (SGB, SGG, SGJ)	2.0 TDI 4motion	103/140	2015/06-	6MT	FD00059-RI	09N409053D	Manual transmission	1
TRANSPORTER VI Minibus (SGB, SGG, SGJ)	2.0 TDI 4motion	110/150	2015/08-	7DCT	FD00058-RI	09N409053E	Automatic transmission	1
TRANSPORTER VI Minibus (SGB, SGG, SGJ)	2.0 TDI 4motion	110/150	2015/08-	6MT	FD00059-RI	09N409053D	Manual transmission	1
TRANSPORTER VI Minibus (SGB, SGG, SGJ)	2.0 TDI 4motion	132/180	2015/06-	7DCT	FD00058-RI	09N409053E	Automatic transmission	1
TRANSPORTER VI Minibus (SGB, SGG, SGJ)	2.0 TDI 4motion	150/204	2015/06-	7DCT	FD00058-RI	09N409053E	Automatic transmission	1
TRANSPORTER VI Minibus (SGB, SGG, SGJ)	2.0 TSI 4motion	150/204	2015/06-	7DCT	FD00058-RI	09N409053E	Automatic transmission	1

All rights reserved.

This publication may not be reproduced in any form, in whole or in part, without a written approval from S-TEC Service Technologies GmbH & Co OG.  
Subject to change without notice!

# Abbreviations 2025

English	Deutsch	Code
4 Speed Automatic Transmission	4 Gang Automatikgetriebe	4AT
5 Speed Automatic Transmission	5 Gang Automatikgetriebe	5AT
6 Speed Automatic Transmission	6 Gang Automatikgetriebe	6AT
7 Speed Automatic Transmission	7 Gang Automatikgetriebe	7AT
8 Speed Automatic Transmission	8 Gang Automatikgetriebe	8AT
5 Speed Manual Transmission	5 Gang Schaltgetriebe	5MT
6 Speed Manual Transmission	6 Gang Schaltgetriebe	6MT
8 Speed Double Clutch Transmission	8 Gang Doppelkupplungsgetriebe	8DCT
Automatic Transmission	Automatikgetriebe	AT
Manual Transmission	Schaltgetriebe	MT
Double Clutch Transmission	Doppelkupplungsgetriebe	DCT

All rights reserved.

This publication may not be reproduced in any form, in whole or in part, without a written approval from S-TEC Service Technologies GmbH & Co OG.  
Subject to change without notice!

**Service Bulletin 001**

**TC00038-RI**

OEM-No.: 3455135  
OEM-No.: 3455136  
OEM-No.: 3455137



**TC00061-RI**

OEM-No.: 3455138



**TC00256-RI**

OEM-No.: 3455132



**TC00037-RI**

OEM-No.: 3455133  
OEM-No.: 3455134  
OEM-No.: 3455139



**Service Bulletin 002**

**X1 (E84) xDrive23d 2009/09 - 2012/06**  
**Transfer Case 2710 7599257**

**TC00266-RI**  
**OEM-No.: 2710 7643748**



**Gear box bushing**  
**OEM-No.: 2231 6773125**

**TC00394-RI**  
**OEM-No.: 2710 7643749**





**Gear box bushing**  
**OEM-No.: 2231 3422956**

### Audi

### Front Axle Drive

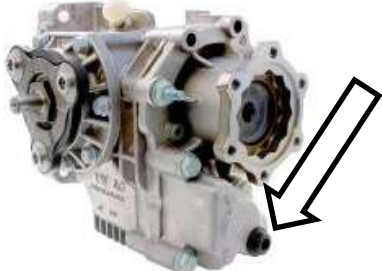
S-TEC Number	OE-Number	1st Filling	Oil	Description	VAA350
FD00041-RI	02M409053AP 02M409050X	900ml	Castrol SAF PD according to TL 52145X	Filled up to oil level plug; delivery with oil	
FD00042-RI	02M409053AT 02M409050AX				

S-TEC Number	OE-Number	1st Filling	Oil	Description	VAA350+
FD00052-RI	0AV409053AE	890ml	Castrol SAF AG4 according to TL 52145	Filled up to oil level plug; delivery with oil	
FD00053-RI	0AV409053AF				

S-TEC Number	OE-Number	1st Filling	Oil	Description	VAA450
FD00049-RI	0A6409053AG	900ml	Castrol SAF AG4 according to TL 52145	Filled up to oil level plug; delivery with oil	
FD00060-RI	0A6409053AH				

All rights reserved.

This publication may not be reproduced in any form, in whole or in part, without a written approval from S-TEC Service Technologies GmbH & Co OG.  
Subject to change without notice!



### Audi

### Rear Axle Drive

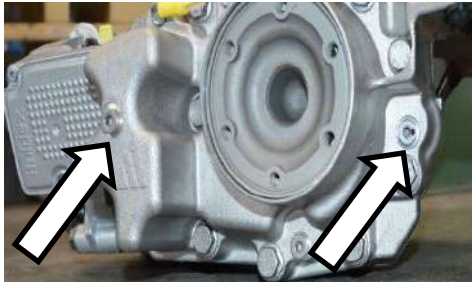
S-TEC Number	OE-Number	1st Filling	Oil	Description	HAA350+
RD00022-RI	0AV525010K	Gearbox: 925ml	Hypoid gear oil Shell TF 0950 according to TL 52517A	Filled up to oil level plug; delivery with oil	
		Clutch: 850ml	Clutch oil Burmah HALBOT 309 F according to TL 52175-X		
RD00023-RI	0AV525010L	Gearbox: 925ml	Hypoid gear oil Shell TF 0950 according to TL 52517A		
		Clutch: 850ml	Clutch oil Burmah HALBOT 309 F according to TL 52175-X		
RD00056-RI	0AV525010M	Gearbox: 925ml	Hypoid gear oil Shell TF 0950 according to TL 52517A		
		Clutch: 850ml	Clutch oil Burmah HALBOT 309 F according to TL 52175-X		
RD00059-RI	0BR525010G	Gearbox: 925ml	Hypoid gear oil Shell TF 0950 according to TL 52517A		
		Clutch: 850ml	Clutch oil STATOIL SL12301 according to TL 52175		
RD00060-RI	0BR525010H	Gearbox: 925ml	Hypoid gear oil Shell TF 0950 according to TL 52517A		
		Clutch: 850ml	Clutch oil STATOIL SL12301 according to TL 52175		

All rights reserved.

This publication may not be reproduced in any form, in whole or in part, without a written approval from S-TEC Service Technologies GmbH & Co OG.  
Subject to change without notice!

### Audi

### Rear Axle Drive

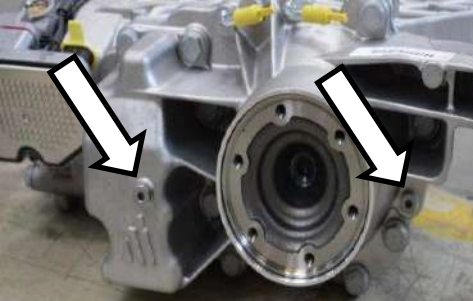
S-TEC Number	OE-Number	1st Filling	Oil	Description	HAA450
RD00007-RI	0BY525010B	Gearbox: 950ml	Hypoid gear oil Shell TF 0950 according to TL 52517A0	Filled up to oil level plug; delivery with oil	
		Clutch: 850ml	Clutch oil STATOIL SL01301 according to TL 52175Z		
RD00061-RI	0BS525010G	Gearbox: 950ml	Hypoid gear oil Shell TF 0950 according to TL 52517A0		
		Clutch: 850ml	Clutch oil STATOIL SL01301 according to TL 52175Z		
RD00074-RI	0BS525010H	Gearbox: 950ml	Hypoid gear oil Shell TF 0950 according to TL 52517A0		
		Clutch: 850ml	Clutch oil STATOIL SL01301 according to TL 52175Z		
RD00099-RI	0BS525010K	Gearbox: 950ml	Hypoid gear oil Shell TF 0950 according to TL 52517A0		
		Clutch: 850ml	Clutch oil STATOIL SL01301 according to TL 52175Z		

### Audi

### Transfer Case

S-TEC Number	OE-Number	1st Filling	Oil	Description	PL72 T
TC00302-RI	0BU341010N	600ml	Castrol BOT 850 TL52 536	Filled up to oil level plug; delivery with oil	
TC00304-RI	0BU341010P				
TC00306-RI	0BU341010Q				

All rights reserved.

This publication may not be reproduced in any form, in whole or in part, without a written approval from S-TEC Service Technologies GmbH & Co OG.  
Subject to change without notice!

### BMW

### Transfer Case

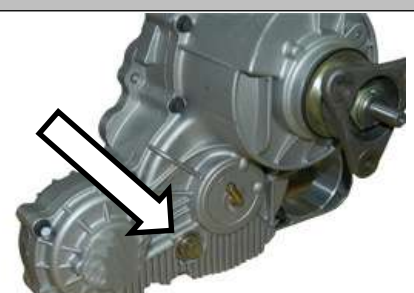
S-TEC Number	OE-Number	1st Filling	Oil	Description	NV124
TC00065-RI	27107509763	240ml	Shell TF 0870 B according to TL7300  S-TEC Number <b>OIL0005</b>  	Filled up to oil level plug; delivery with oil	
TC00066-RI	27107530812				

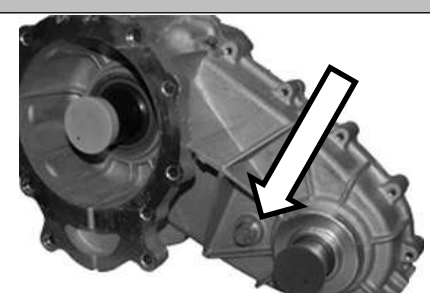
S-TEC Number	OE-Number	1st Filling	Oil	Description	NV125
TC00049-RI	27107504568	500ml	ATF Dexron II	Filled up to oil level plug; delivery with oil	
TC00068-RI	27107504567				

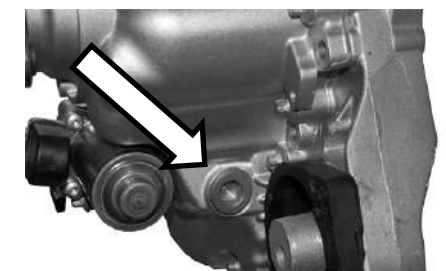
S-TEC Number	OE-Number	1st Filling	Oil	Description	ATC300
TC00035-RI	27107599693	620ml	Shell TF 0870 B according to TL7300  S-TEC Number <b>OIL0005</b>  	Filled up to oil level plug; delivery with oil	
TC00285-RI	27107613153				

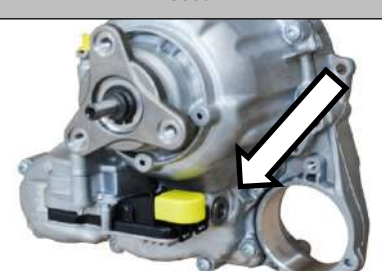
S-TEC Number	OE-Number	1st Filling	Oil	Description	ATC350
TC00266-RI	27107643748 27108697976	620ml	Shell TF 0870 B according to TL7300  S-TEC Number <b>OIL0005</b>  	Filled up to oil level plug; delivery with oil	
TC00267-RI	27107643750 27108697978				
TC00394-RI	27107643749 27108697977				

All rights reserved.  
 This publication may not be reproduced in any form, in whole or in part, without a written approval from S-TEC Service Technologies GmbH & Co OG.  
 Subject to change without notice!

### BMW

### Transfer Case

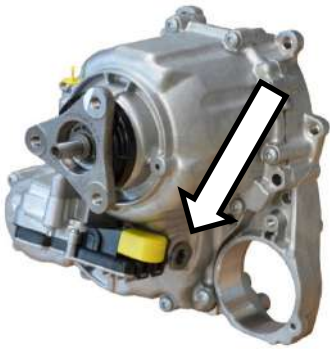
S-TEC Number	OE-Number	1st Filling	Oil	Description	ATC35L
TC00408-RI	27108643150 27108662968 27107649718	620ml	Shell TF 0870 B according to TL7300  S-TEC Number <b>OIL0005</b>  	Filled up to oil level plug; delivery with oil	
TC00410-RI	27107643755 27107649181				
TC00413-RI	27107643754 27108697975				
TC00414-RI	27108643149 27108662300 27107649725				

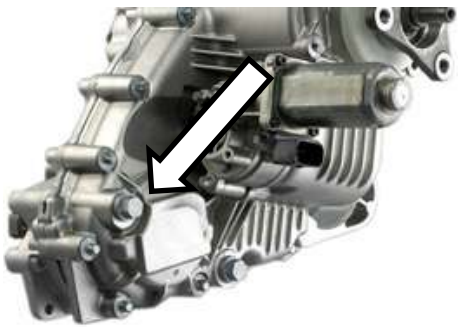

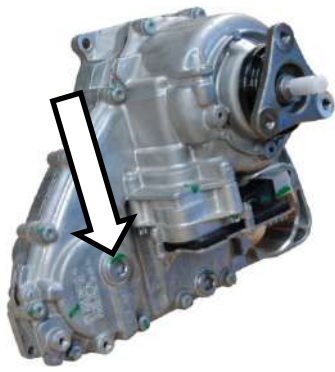
S-TEC Number	OE-Number	1st Filling	Oil	Description	ATC400
TC00037-RI	27103455136 27103455139	800ml	Shell TF 0870 B according to TL7300  S-TEC Number <b>OIL0005</b>  	Filled up to oil level plug; delivery with oil	
TC00038-RI	27103455135 27103455137				
TC00061-RI	27103455138				
TC00256-RI	27103455132				



S-TEC Number	OE-Number	1st Filling	Oil	Description	ATC450
TC00398-RI	27107643751 27108697972	700ml	Shell TF 0870 B according to TL7300  S-TEC Number <b>OIL0005</b>  	Filled up to oil level plug; delivery with oil	
TC00399-RI	27107643753 27108697974				
TC00400-RI	27107643752 27108697973				



All rights reserved.  
 This publication may not be reproduced in any form, in whole or in part, without a written approval from S-TEC Service Technologies GmbH & Co OG.  
 Subject to change without notice!

### BMW

### Transfer Case

S-TEC Number	OE-Number	1st Filling	Oil	Description	ATC45L
TC00396-RI	27107643758 27107649182	700ml	Shell TF 0870 B according to TL7300  S-TEC Number <b>OIL0005</b>  	Filled up to oil level plug; delivery with oil	
TC00397-RI	27107643759 27108697256				
TC00401-RI	27108643151 27108697255				
TC00403-RI	27108643152 27108697257				
TC00416-RI	27107854164				



S-TEC Number	OE-Number	1st Filling	Oil	Description	ATC500
TC00039-RI	27107555297	900ml	Shell TF 0870 B according to TL7300  S-TEC Number <b>OIL0005</b>  	Filled up to oil level plug; delivery with oil	

S-TEC Number	OE-Number	1st Filling	Oil	Description	ATC700
TC00200-RI	27107599889	900ml	Shell TF 0870 B according to TL7300  S-TEC Number <b>OIL0005</b>  	Filled up to oil level plug; delivery with oil	
TC00261-RI	27107599890				
TC00260-RI	27107599899				

All rights reserved.  
 This publication may not be reproduced in any form, in whole or in part, without a written approval from S-TEC Service Technologies GmbH & Co OG.  
 Subject to change without notice!

### BMW

### Transfer Case

S-TEC Number	OE-Number	1st Filling	Oil	Description	LWX500
TC00415-RI	27107519533	500ml	Shell TF 0870 B according to TL7300  S-TEC Number <b>OIL0005</b>  	Filled up to oil level plug; delivery with oil	

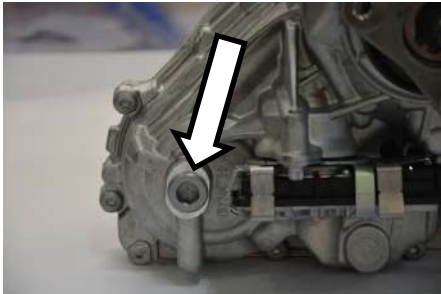
S-TEC Number	OE-Number	1st Filling	Oil	Description	ATC13-1
TC00555-RI TC00556-RI TC00557-RI		700ml	Shell TF 0870 B according to TL7300  S-TEC Number <b>OIL0005</b>  	Filled up to oil level plug; delivery with oil	

### Chrysler

### Front Axle Drive / Power Take Off / Transfer Case

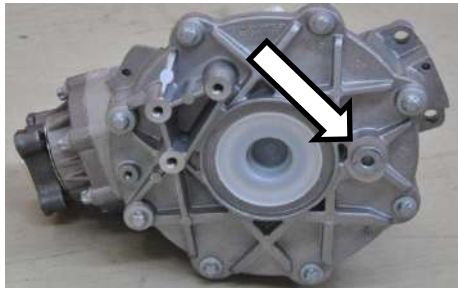
S-TEC Number	OE-Number	1st Filling	Oil	Description	DC LX
FD00045-RI	04591954AB	600ml	Shell SAE 75W-90 according to TL7301	Filled up to oil level plug; <b>delivery without oil</b>	
FD00061-RI	04591954AE				

S-TEC Number	OE-Number	1st Filling	Oil	Description	T115
FD00055-RI	04641900AA	1140ml	Mobil Gear Oil Chrysler 80W90	Filled up to oil level plug; delivery with oil	
FD00056-RI	04641900AB 04641934AB				
FD00057-RI	04641934AA				

S-TEC Number	OE-Number	1st Filling	Oil	Description	LX
TC00008-RI	04591953AI	585ml	ESSO ATF MB 274	Filled up to oil level plug; <b>delivery without oil</b>	

All rights reserved.  
 This publication may not be reproduced in any form, in whole or in part, without a written approval from S-TEC Service Technologies GmbH & Co OG.  
 Subject to change without notice!



### FIAT

### Rear Axle Drive

S-TEC Number	OE-Number	1st Filling	Oil	Description	RDM
RD01016-RI	55216569	715ml	Castrol Burmah BOT 190M	Filled up to oil level plug; delivery with oil	
RD01017-RI	55216570				
RD01018-RI	55234679				
RD01019-RI	55234680				

S-TEC Number	OE-Number	1st Filling	Oil	Description	RDM (312/319)
RD00095-RI	55263470	715ml	Castrol BOT 355	Filled up to oil level plug; delivery without oil	

### General Motors

### Power Take Off / Rear Axle Drive

S-TEC Number	OE-Number	1st Filling	Oil	Description	EDW
FD00034-RI	89059706	290ml	BOT 190 M1 SAE 75W-85, API GL 5	Filled up to oil level plug; <b>delivery without oil</b>	
FD00035-RI	89059707				
FD00036-RI	89059708				

S-TEC Number	OE-Number	1st Filling	Oil	Description	EDW
RD01001-RI	88894200	2040ml	BOT 190 M1 SAE 75W-85, API GL 5	Filled up to oil level plug; <b>delivery without oil</b>	

All rights reserved.

This publication may not be reproduced in any form, in whole or in part, without a written approval from S-TEC Service Technologies GmbH & Co OG.  
Subject to change without notice!

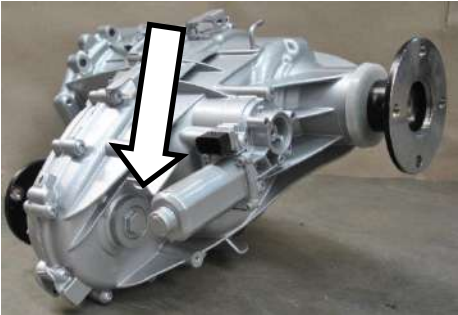

### Infinit

### Transfer Case

S-TEC Number	OE-Number	1st Filling	Oil	Description	W61G
TC00271-RI	331001LA0D	1500ml	Shell TF 0870 according to TL7300  S-TEC Number <b>OIL0005</b>	Filled up to oil level plug; delivery with oil	

### Jaguar

### Front Axle Drive

S-TEC Number	OE-Number	1st Filling	Oil	Description	Jaguar ATC
TC00511-RI		620ml	Shell TF 0870 B according to TL7300  S-TEC Number <b>OIL0005</b>  	Filled up to oil level plug; <b>delivery without oil</b>	



### Land Rover

### Front Axle Drive

S-TEC Number	OE-Number	1st Filling	Oil	Description	LF FAD
FD00063-RI	7G9N7L486AB LR040657 LR066503	800ml	Castrol BOT 118 Plus 75W90 API GL5	Filled up to oil level plug; delivery without oil	

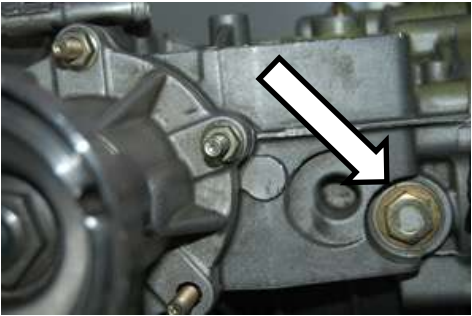
### Land Rover Transfer Case

S-TEC Number	OE-Number	1st Filling	Oil	Description	CB40
TC00006-RI	TAG000220	1100ml	Fuchs Titan Speed 75W90	Filled up to oil level plug; <b>delivery without oil</b>	
			Texaco Geartex S5 75W-90		
TC00007-RI	TAG000230	1100ml	Fuchs Titan Speed 75W90	Filled up to oil level plug; <b>delivery without oil</b>	
			Texaco Geartex S5 75W-90		

S-TEC Number	OE-Number	1st Filling	Oil	Description	ITC PLA, ITC PLA 2-Speed
TC00404-RI TC00487-RI	LR049160 LR006016 LR008206 LR089531	1500ml	TL 7300-SHELL TF 0753 B Shell TF 0870 B according to TL7300  S-TEC Number <b>OIL0005</b>  	Filled up to oil level plug; delivery with oil	

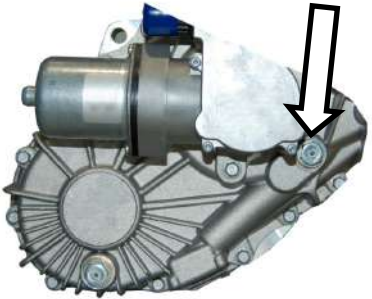
S-TEC Number	OE-Number	1st Filling	Oil	Description	NV225
TC00012-RI	IAB500033	1000ml	BOT 26 FMB 1 SAE 75W-90	Filled up to oil level plug; delivery with oil	

All rights reserved.  
 This publication may not be reproduced in any form, in whole or in part, without a written approval from S-TEC Service Technologies GmbH & Co OG.  
 Subject to change without notice!

### Mercedes-Benz

### Front Axle Drive

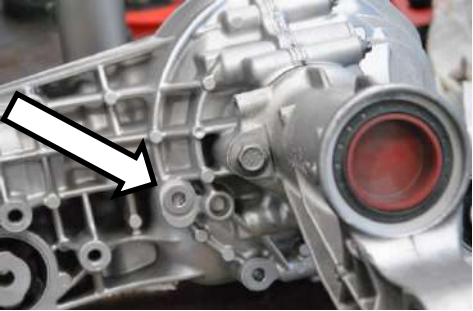
S-TEC Number	OE-Number	1st Filling	Oil	Description	A164
FD00030-RI	A1643302402	1100ml	Hypoidgetriebeöl FE Plus NG 75W-85 (A 001 989 33 03)	Filled up to oil level plug; <b>delivery without oil</b>	
FD00031-RI	A1643302202				
FD00032-RI	A1643302102				
FD00033-RI	A1643302002				

All rights reserved.

This publication may not be reproduced in any form, in whole or in part, without a written approval from S-TEC Service Technologies GmbH & Co OG.  
Subject to change without notice!

### Mercedes-Benz Transfer Case

S-TEC Number	OE-Number	1st Filling	Oil	Description	SEC
TC00185-RI	A2202800700	585ml	Esso ATF MB274	Filled up to oil level plug; delivery with oil	
TC00187-RI	A2112801000				
TC00203-RI	A2112800900				
TC00210-RI	A2032800700				

S-TEC Number	OE-Number	1st Filling	Oil	Description	W210
TC00014-RI	A2102800100	850ml	Shell LA 3403-M115	Filled up to oil level plug; <b>delivery without oil</b>	
TC00015-RI	A2102800300				
TC00016-RI	A2102800400				

S-TEC Number	OE-Number	1st Filling	Oil	Description	VG80
TC00019-RI	A4602803600	2300ml	Shell Spirax MA 80W	Filled up to oil level plug; <b>delivery without oil</b>	

All rights reserved.  
This publication may not be reproduced in any form, in whole or in part, without a written approval from S-TEC Service Technologies GmbH & Co OG.  
Subject to change without notice!

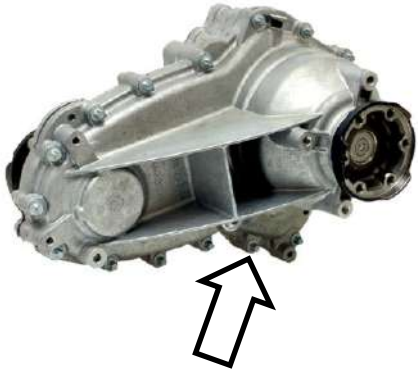

### Mercedes-Benz Transfer Case

S-TEC Number	OE-Number	1st Filling	Oil	Description	DCS
TC00268-RI	A2512801300	500ml	TL7300-ATF 3353	Filled up to oil level plug; delivery with oil	
TC00274-RI	A2512802700 A2512803100				
TC00282-RI	A2512801400				
TC00283-RI	A2512801700				
TC00527-RI	A2512803200				
TC00537-RI	A2512802800				

S-TEC Number	OE-Number	1st Filling	Oil	Description	DCD
TC00269-RI	A1642801200	1500ml	TL7300-ATF 3353	Filled up to oil level plug; delivery with oil	
TC00280-RI	A1662800800				

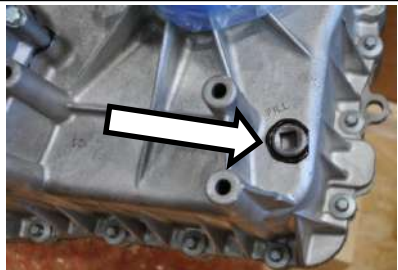
S-TEC Number	OE-Number	1st Filling	Oil	Description	A163 (BW 4409)
TC00492-RI	A1632800800	1500ml	ATF A0019892103	Filled up to oil level plug; delivery with oil	

### Mercedes-Benz Transfer Case

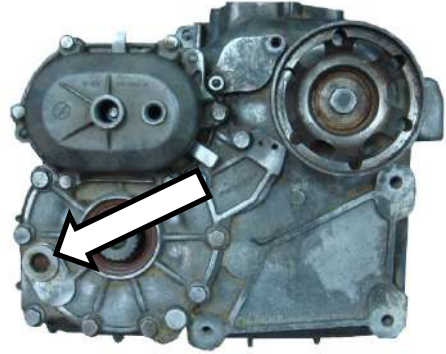
S-TEC Number	OE-Number	1st Filling	Oil	Description	VG150 E
TC00023-RI	A4632801700	2800ml	Fuchs TITAN EG 5080 DBL6634.50	Filled up to oil level plug; <b>delivery without oil</b>	

S-TEC Number	OE-Number	1st Filling	Oil	Description	VG150
TC00022-RI	A4632801500	2800ml	Fuchs TITAN EG 5080 DBL6634.50	Filled up to oil level plug; <b>delivery without oil</b>	
TC00276-RI	A4632801000				
TC00277-RI	A4632801100				
TC00278-RI	A4632801400				

All rights reserved.

This publication may not be reproduced in any form, in whole or in part, without a written approval from S-TEC Service Technologies GmbH & Co OG.  
Subject to change without notice!

### Nissan Transfer Case

S-TEC Number	OE-Number	1st Filling	Oil	Description	D40M
TC00048-RI	33100EA301	2200ml	ATF Dexron II	Filled up to oil level plug; delivery with oil	
TC00441-RI	33100EA31B				

S-TEC Number	OE-Number	1st Filling	Oil	Description	W61G
TC00271-RI	331001LA0D	1500ml	Shell TF 0870 according to TL7300	Filled up to oil level plug; delivery with oil	
TC00272-RI	331001LU0B				

### Porsche

### Front Axle Drive

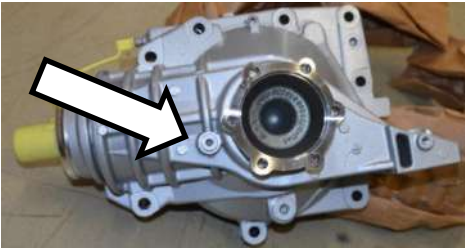

S-TEC Number	OE-Number	1st Filling	Oil	Description	Panamera G1
FD00067-RI	97034901153	525ml	Shell hypoid gear oil TF 951 B (GTL)	Filled up to oil level plug; delivery with oil	
FD00068-RI	97034901123				
FD00069-RI	97034901103				



All rights reserved.

This publication may not be reproduced in any form, in whole or in part, without a written approval from S-TEC Service Technologies GmbH & Co OG.  
Subject to change without notice!

### Porsche Transfer Case

S-TEC Number	OE-Number	1st Filling	Oil	Description	NV235
TC00181-RI	95534104055	850ml	Shell Synthetic Oil TF 0870	Filled up to oil level plug; delivery with oil	
TC00182-RI	95534104005				
TC00183-RI	95534104024				
TC00184-RI	95534104014				
TC00491-RI	95534104030				

S-TEC Number	OE-Number	1st Filling	Oil	Description	PL72 ATC
TC00299-RI	0C2341012K 95834101009	980ml	Shell TF 0870 B according to TL7300  S-TEC Number <b>OIL0005</b> 	Filled up to oil level plug; delivery with oil	
TC00300-RI	0C2341012L 95834101019				
TC00301-RI	0C2341012M 95834101028				
TC00467-RI	0C2341012N 95834101034				

S-TEC Number	OE-Number	1st Filling	Oil	Description	PL72 ATC NG
TC00504-RI	95834101204 0C2341041J	980ml	Shell TF 0870 B according to TL7300  S-TEC Number <b>OIL0005</b> 	Filled up to oil level plug; delivery with oil	
TC00505-RI	95834101303 0C2341041K				
TC00506-RI	95834101214 0C2341041M				
TC00507-RI	95834101308 0C2341041L				

All rights reserved.

This publication may not be reproduced in any form, in whole or in part, without a written approval from S-TEC Service Technologies GmbH & Co OG.  
Subject to change without notice!

### Porsche Transfer Case

S-TEC Number	OE-Number	1st Filling	Oil	Description	PL72 T
TC00311-RI	95834102003	600ml	Castrol BOT 850 TL52 536	Filled up to oil level plug; delivery with oil	
TC00319-RI	95834102021				
TC00323-RI	95834102012				

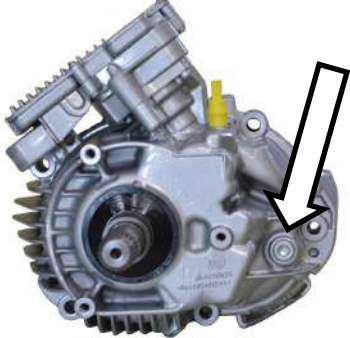
S-TEC Number	OE-Number	1st Filling	Oil	Description	95B
TC00494-RI	95B341010A	550ml	Shell TF 0870 B according to TL7300  S-TEC Number <b>OIL0005</b> 	Filled up to oil level plug; delivery with oil	

## Renault

### Rear Axle Drive

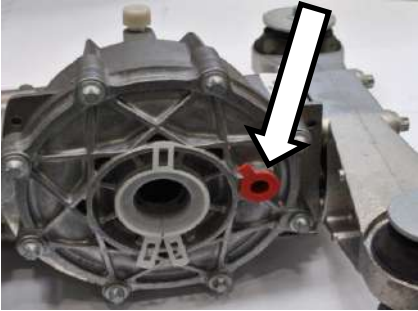
S-TEC Number	OE-Number	1st Filling	Oil	Description	J64
RD00021-RI	7700112918	800ml	ELF Tranself Universal SAE80W90 (GL5)	Filled up to oil level plug; <b>delivery without oil</b>	

### SEAT

### Front Axle Drive

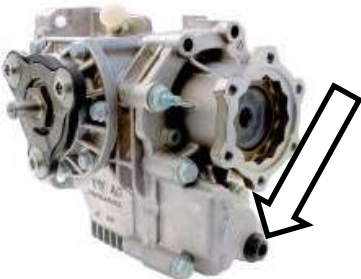
S-TEC Number	OE-Number	1st Filling	Oil	Description	VAA350+
FD00052-RI	0AV409053AE	890ml	Castrol SAF AG4 according to TL 52145	Filled up to oil level plug; delivery with oil	



### SEAT

### Rear Axle Drive

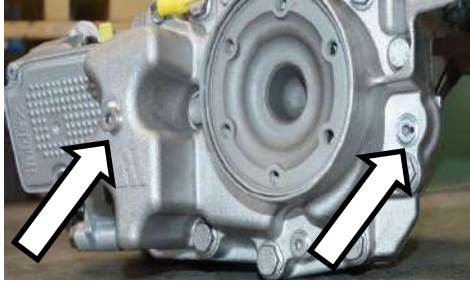
S-TEC Number	OE-Number	1st Filling	Oil	Description	HAA350+
RD00022-RI	0AV525010K	Gearbox: 925ml	Hypoid gear oil Shell TF 0950 according to TL 52517A	Filled up to oil level plug; delivery with oil	
		Clutch: 850ml	Clutch oil Burmah HALBOT 309 F according to TL 52175-X		
RD00023-RI	0AV525010L	Gearbox: 925ml	Hypoid gear oil Shell TF 0950 according to TL 52517A		
		Clutch: 850ml	Clutch oil Burmah HALBOT 309 F according to TL 52175-X		
RD00059-RI	0BR525010G	Gearbox: 925ml	Hypoid gear oil Shell TF 0950 according to TL 52517A		
		Clutch: 850ml	Clutch oil STATOIL SL12301 according to TL 52175		

### Skoda

### Front Axle Drive

S-TEC Number	OE-Number	1st Filling	Oil	Description	VAA350+
FD00046-RI	0AV409053K	890ml	Castrol SAF AG4 according to TL 52145	Filled up to oil level plug; delivery with oil	
FD00052-RI	0AV409053AE	890ml	Castrol SAF AG4 according to TL 52145		
FD00054-RI	0AV409053AG	890ml	Castrol SAF AG4 according to TL 52145		

S-TEC Number	OE-Number	1st Filling	Oil	Description	MQ
FD00044-RI	02D409053E	-	Castrol MTF95+EP+FM synthetic oil for manual transmissions	Filled via gearbox up to 15 mm below gearbox oil plug level; <b>delivery without oil</b>	

### Skoda

### Rear Axle Drive

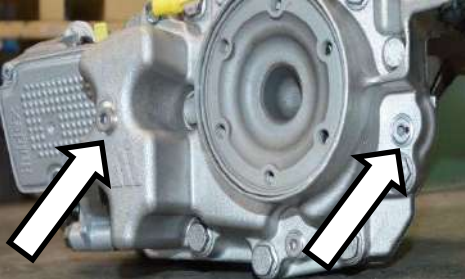
S-TEC Number	OE-Number	1st Filling	Oil	Description	HAA350+
RD00022-RI	0AV525010K	Gearbox: 925ml	Hypoid gear oil Shell TF 0950 according to TL 52517A	Filled up to oil level plug; delivery with oil	
		Clutch: 850ml	Clutch oil Burmah HALBOT 309 F according to TL 52175-X		
RD00059-RI	0BR525010G	Gearbox: 925ml	Hypoid gear oil Shell TF 0950 according to TL 52517A		
		Clutch: 850ml	Clutch oil STATOIL SL12301 according to TL 52175		
RD00102-RI	0BR525010E	Gearbox: 925ml	Hypoid gear oil Shell TF 0950 according to TL 52517A		
		Clutch: 760ml	Clutch oil STATOIL SL12301 according to TL 52175		

All rights reserved.

This publication may not be reproduced in any form, in whole or in part, without a written approval from S-TEC Service Technologies GmbH & Co OG.  
Subject to change without notice!

### Volvo

### Front Axle Drive

S-TEC Number	OE-Number	1st Filling	Oil	Description	XC FAD
FD00070-RI	36002479	800ml	Castrol BOT 118 Plus 75W90 API GL5	Filled up to oil level plug; <b>delivery without oil</b>	

### Volvo

### Rear Axle Drive

S-TEC Number	OE-Number	1st Filling	Oil	Description	XC RAD
RD00103-RI	36001720	700ml	Castrol BOT 118 Plus 75W90 API GL5	Filled up to oil level plug; <b>delivery without oil</b>	

### VW

### Front Axle Drive

S-TEC Number	OE-Number	1st Filling	Oil	Description	VAA350
FD00041-RI	02M409053AP 02M409050X	900ml	Castrol SAF PD according to TL 52145X	Filled up to oil level plug; delivery with oil	

S-TEC Number	OE-Number	1st Filling	Oil	Description	VAA350+
FD00046-RI	0AV409053K	890ml	Castrol SAF AG4 according to TL 52145	Filled up to oil level plug; delivery with oil	
FD00052-RI	0AV409053AE				
FD00053-RI	0AV409053AF				
FD00054-RI	0AV409053AG				

S-TEC Number	OE-Number	1st Filling	Oil	Description	VAA450
FD00049-RI	0A6409053AG	900ml	Castrol SAF AG4 according to TL 52145	Filled up to oil level plug; delivery with oil	
FD00051-RI	0AU409053T				
FD00060-RI	0A6409053AH				

All rights reserved.  
This publication may not be reproduced in any form, in whole or in part, without a written approval from S-TEC Service Technologies GmbH & Co OG.  
Subject to change without notice!

### VW

### Front Axle Drive

S-TEC Number	OE-Number	1st Filling	Oil	Description	M300+
FD00047-RI	02G409053	800ml	Castrol MTF95+EP+FM synthetic oil for manual transmissions	Filled up to oil level plug; <b>delivery without oil</b>	
			VP1-1090-26-01 (BOT 142/96 B Burmah 26)		

S-TEC Number	OE-Number	1st Filling	Oil	Description	MQ
FD00043-RI	02D409053B	-	Castrol MTF95+EP+FM synthetic oil for manual transmissions	Filled via gearbox up to 15 mm below gearbox oil plug level; <b>delivery without oil</b>	
FD00044-RI	02D409053E				

All rights reserved.

This publication may not be reproduced in any form, in whole or in part, without a written approval from S-TEC Service Technologies GmbH & Co OG.  
Subject to change without notice!

### VW

### Rear Axle Drive

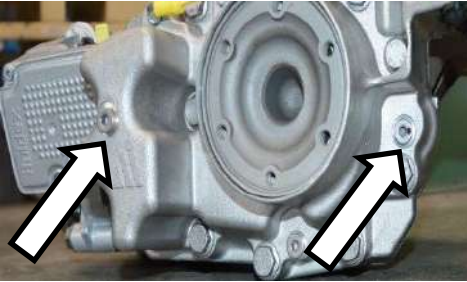
S-TEC Number	OE-Number	1st Filling	Oil	Description	HAA350+
RD00022-RI	0AV525010K	Gearbox: 925ml	Hypoid gear oil Shell TF 0950 according to TL 52517A	Filled up to oil level plug; delivery with oil	
		Clutch: 850ml	Burmah HALBOT 309 F according to TL 52175-X		
RD00023-RI	0AV525010L	Gearbox: 925ml	Hypoid gear oil Shell TF 0950 according to TL 52517A		
		Clutch: 850ml	Burmah HALBOT 309 F according to TL 52175-X		
RD00059-RI	0BR525010G	Gearbox: 925ml	Hypoid gear oil Shell TF 0950 according to TL 52517A		
		Clutch: 850ml	Clutch oil STATOIL SL12301 according to TL 52175		

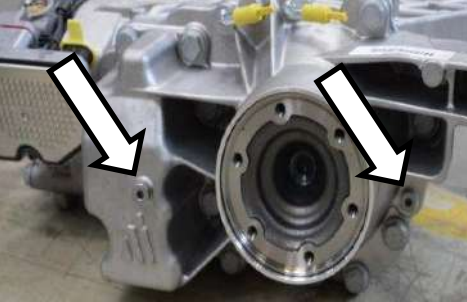
S-TEC Number	OE-Number	1st Filling	Oil	Description	HAA450
RD00040-RI	01Z525010D	Gearbox: 950ml	Hypoid gear oil Shell TF 0950 according to TL 52517A	Filled up to oil level plug; delivery with oil	
		Clutch: 850ml	Clutch oil STATOIL SL01301 according to TL 52175Z		
RD00042-RI	01Z525010J	Gearbox: 950ml	Hypoid gear oil Shell TF 0950 according to TL 52517A		
		Clutch: 850ml	Clutch oil STATOIL SL01301 according to TL 52175Z		
RD00043-RI	01Z525010K	Gearbox: 950ml	Hypoid gear oil Shell TF 0950 according to TL 52517A		
		Clutch: 850ml	Clutch oil STATOIL SL01301 according to TL 52175Z		
RD00058-RI	0AY525010L	Gearbox: 950ml	Hypoid gear oil Shell TF 0950 according to TL 52517A0		
		Clutch: 850ml	Clutch oil STATOIL SL01301 according to TL 52175-Z		
RD00061-RI	0BS525010G	Gearbox: 950ml	Hypoid gear oil Shell TF 0950 according to TL 52517A0		
		Clutch: 850ml	Clutch oil STATOIL SL01301 according to TL 52175Z		
RD00100-RI	0AY525010F	Gearbox: 950ml	Hypoid gear oil Shell TF 0950 according to TL 52517A0		
		Clutch: 1000ml	Clutch oil STATOIL SL01301 according to TL 52175Z		

All rights reserved.

This publication may not be reproduced in any form, in whole or in part, without a written approval from S-TEC Service Technologies GmbH & Co OG.  
Subject to change without notice!



### VW

### Rear Axle Drive

S-TEC Number	OE-Number	1st Filling	Oil	Description	T4 M300+
RD00038-RI	02D525011H	Gearbox: 1300ml	Hypoid gear oil SAE 75W according to TL 52726	Filled up to oil level plug; delivery with oil	
RD00047-RI	02D525012E	Gearbox: 1300ml	Hypoid gear oil SAE 75W according to TL 52726		
RD00051-RI	02D525015E	Gearbox: 1300ml	Hypoid gear oil SAE 75W according to TL 52726		
RD00055-RI	02D525016E	Gearbox: 1300ml	Hypoid gear oil SAE 75W according to TL 52726		

All rights reserved.

This publication may not be reproduced in any form, in whole or in part, without a written approval from S-TEC Service Technologies GmbH & Co OG.  
Subject to change without notice!

### VW

### Transfer Case

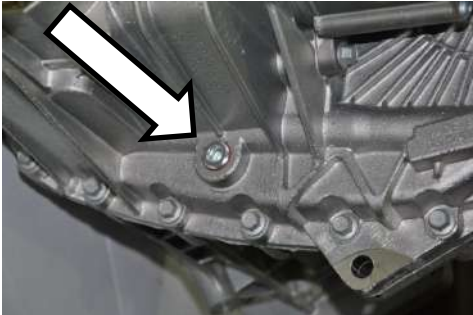
S-TEC Number	OE-Number	1st Filling	Oil	Description	NV235
TC00177-RI	0AD341011K	850ml	Shell Synthetic Oil TF 0870	Filled up to oil level plug; delivery with oil	
TC00178-RI	0AD341011L				
TC00179-RI	0AD341011M				
TC00180-RI	0AD341011N				
TC00181-RI	0BV341010K				
TC00298-RI	0BV341010H				

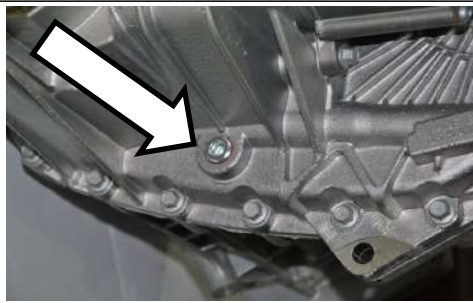
S-TEC Number	OE-Number	1st Filling	Oil	Description	NV235 PL72
TC00297-RI	0BV341010K	850ml	Shell Synthetic Oil TF 0870	Filled up to oil level plug; delivery with oil	
TC00298-RI	0BV341010H				

S-TEC Number	OE-Number	1st Filling	Oil	Description	PL72 T
TC00311-RI	0BU341011Q	600ml	Castrol BOT 850 TL52 536	Filled up to oil level plug; delivery with oil	
TC00314-RI	0BU341011R				
TC00316-RI	0BU341011N				
TC00319-RI	0BU341011T				
TC00323-RI	0BU341011M				
TC00326-RI	0BU341011F				
TC00328-RI	0BU341011S				

All rights reserved.  
 This publication may not be reproduced in any form, in whole or in part, without a written approval from S-TEC Service Technologies GmbH & Co OG.  
 Subject to change without notice!

### Brand - Series

### Maingroup - Subgroup

### Audi - A3

#### Front Axle, Steering Unit - Power take off (PTO)

OEM no	Successor no	Part number
02M409053AQ	0AV409053AE	FD00052-RI
0A6409053AD	0A6409053AH	FD00060-RI
0A6409053AF	0A6409053AH	FD00060-RI
0A6409053AH		FD00060-RI
0A6409053AM	0A6409053AH	FD00060-RI
0A6409053S	0A6409053AH	FD00060-RI
0AV409053AE		FD00052-RI
0AV409053AF		FD00053-RI
0AV409053H	0AV409053AE	FD00052-RI
0AV409053J	0AV409053AF	FD00053-RI
0AV409053P	0AV409053AE	FD00052-RI
0AV409053Q	0AV409053AF	FD00053-RI
0AV409053S	0AV409053AE	FD00052-RI
0AV409053T	0AV409053AF	FD00053-RI

#### Rear Axle - Rear Differential

OEM no	Successor no	Part number
0AV525010	0AV525010K	RD00022-RI
0AV525010A	0AV525010L	RD00023-RI
0AV525010B	0AV525010K	RD00022-RI
0AV525010C	0AV525010L	RD00023-RI
0AV525010D	0AV525010K	RD00022-RI
0AV525010E	0AV525010L	RD00023-RI
0AV525010H	0AV525010K	RD00022-RI
0AV525010K		RD00022-RI
0AV525010L		RD00023-RI
0BR525010	0BR525010G	RD00059-RI
0BR525010B	0BR525010G	RD00059-RI
0BR525010G		RD00059-RI

### Audi - A4

#### Rear Axle - Rear Differential

OEM no	Successor no	Part number
0BF500043Q		RD00008-RI

### Audi - A5

#### Rear Axle - Rear Differential

OEM no	Successor no	Part number
0BF500043Q		RD00008-RI

All rights reserved.

This publication may not be reproduced in any form, in whole or in part, without a written approval from S-TEC Service Technologies GmbH & Co OG.  
Subject to change without notice!

### Brand - Series

### Maingroup - Subgroup

#### Audi - A6

##### Rear Axle - Rear Differential

OEM no	Successor no	Part number
0BF500043Q		RD00008-RI

#### Audi - A6 allroad

##### Gearbox, Powertrain - Gearbox

OEM no	Successor no	Part number
01E300009		SP00441
01E30009A		SP00442

#### Audi - A7

##### Rear Axle - Rear Differential

OEM no	Successor no	Part number
0BF500043Q		RD00008-RI

#### Audi - A8

##### Rear Axle - Rear Differential

OEM no	Successor no	Part number
0BE500043C		RD00009-RI

#### Audi - Q3

##### Front Axle, Steering Unit - Power take off (PTO)

OEM no	Successor no	Part number
02M409053AQ	0AV409053AE	FD00052-RI
0A6409053AA	0A6409053AG	FD00049-RI
0A6409053AB	0A6409053AG	FD00049-RI
0A6409053AC	0A6409053AG	FD00049-RI
0A6409053AD	0A6409053AH	FD00060-RI
0A6409053AE	0A6409053AG	FD00049-RI
0A6409053AF	0A6409053AH	FD00060-RI
0A6409053AG		FD00049-RI
0A6409053AH		FD00060-RI
0A6409053AK		FD00021-RI
0A6409053AL	0A6409053AG	FD00049-RI
0A6409053AM	0A6409053AH	FD00060-RI
0A6409053B	0A6409053AG	FD00049-RI
0A6409053N	0A6409053AG	FD00049-RI
0A6409053Q	0A6409053AG	FD00049-RI
0A6409053S	0A6409053AH	FD00060-RI
0A6409053T	0A6409053AG	FD00049-RI
0AV409053AE		FD00052-RI
0AV409053H	0AV409053AE	FD00052-RI
0AV409053P	0AV409053AE	FD00052-RI
0AV409053S	0AV409053AE	FD00052-RI

All rights reserved.

This publication may not be reproduced in any form, in whole or in part, without a written approval from S-TEC Service Technologies GmbH & Co OG.  
Subject to change without notice!

### Brand - Series

### Maingroup - Subgroup

### Audi - Q3

#### Rear Axle - Rear Differential

OEM no	Successor no	Part number
0AY525010F	0AY525010N	RD00100-RI
0AY525010N		RD00100-RI
0BS525010A	0BS525010G	RD00061-RI
0BS525010B	0BS525010G	RD00061-RI
0BS525010C	0BS525010H	RD00074-RI
0BS525010D	0AY525010N	RD00100-RI
0BS525010G		RD00061-RI
0BS525010H		RD00074-RI
0BS525010J	0BS525010K	RD00099-RI
0BS525010K		RD00099-RI

### Audi - Q7

#### Gearbox, Powertrain - Transfer Case

OEM no	Successor no	Part number
0BU341010N		TC00302-RI
0BU341010P		TC00304-RI
0BU341010Q		TC00306-RI

### Audi - TT

#### Front Axle, Steering Unit - Power take off (PTO)

OEM no	Successor no	Part number
02M409050AX		FD00042-RI
02M409050X		FD00041-RI
02M409053AP		FD00041-RI
02M409053AQ	0AV409053AE	FD00052-RI
02M409053AT		FD00042-RI
0A6409053AA	0A6409053AG	FD00049-RI
0A6409053AB	0A6409053AG	FD00049-RI
0A6409053AC	0A6409053AG	FD00049-RI
0A6409053AD	0A6409053AH	FD00060-RI
0A6409053AE	0A6409053AG	FD00049-RI
0A6409053AF	0A6409053AH	FD00060-RI
0A6409053AG		FD00049-RI
0A6409053AH		FD00060-RI
0A6409053AL	0A6409053AG	FD00049-RI
0A6409053AM	0A6409053AH	FD00060-RI
0A6409053B	0A6409053AG	FD00049-RI
0A6409053N	0A6409053AG	FD00049-RI
0A6409053Q	0A6409053AG	FD00049-RI
0A6409053S	0A6409053AH	FD00060-RI
0A6409053T	0A6409053AG	FD00049-RI
0AV409053AE		FD00052-RI
0AV409053AF		FD00053-RI

All rights reserved.

This publication may not be reproduced in any form, in whole or in part, without a written approval from S-TEC Service Technologies GmbH & Co OG.  
Subject to change without notice!

### Brand - Series

### Maingroup - Subgroup

### Audi - TT

#### Front Axle, Steering Unit - Power take off (PTO)

OEM no	Successor no	Part number
0AV409053H	0AV409053AE	FD00052-RI
0AV409053J	0AV409053AF	FD00053-RI
0AV409053P	0AV409053AE	FD00052-RI
0AV409053Q	0AV409053AF	FD00053-RI
0AV409053S	0AV409053AE	FD00052-RI
0AV409053T	0AV409053AF	FD00053-RI

#### Rear Axle - Rear Differential

OEM no	Successor no	Part number
0AV525010	0AV525010K	RD00022-RI
0AV525010B	0AV525010K	RD00022-RI
0AV525010D	0AV525010K	RD00022-RI
0AV525010F	0AV525010M	RD00056-RI
0AV525010H	0AV525010K	RD00022-RI
0AV525010K		RD00022-RI
0AV525010M		RD00056-RI
0BR525010	0BR525010G	RD00059-RI
0BR525010A	0BR525010H	RD00060-RI
0BR525010B	0BR525010G	RD00059-RI
0BR525010C	0BR525010H	RD00060-RI
0BR525010G		RD00059-RI
0BR525010H		RD00060-RI
0BY525010	0BY525010B	RD00007-RI
0BY525010A	0BY525010B	RD00007-RI
0BY525010B		RD00007-RI

All rights reserved.

This publication may not be reproduced in any form, in whole or in part, without a written approval from S-TEC Service Technologies GmbH & Co OG.  
Subject to change without notice!

### Brand - Series

### Maingroup - Subgroup

### BMW - 1

#### Gearbox, Powertrain - Transfer Case

OEM no	Successor no	Part number
27104603370	27105A371F1; 27105A371F3	TC00408-RI
27105A371F0		TC00414-RI
27105A371F1		TC00408-RI
27105A371F2		TC00414-RI
27105A371F3		TC00408-RI
27107505374	27105A371F0; 27105A371F2	TC00414-RI
27107505375	27105A371F1; 27105A371F3	TC00408-RI
27107617503	27105A371F0; 27105A371F2	TC00414-RI
27107622018	27105A371F0; 27105A371F2	TC00414-RI
27107629172	27105A371F0; 27105A371F2	TC00414-RI
27107629176	27105A371F0; 27105A371F2	TC00414-RI
27107629521	27105A371F1; 27105A371F3	TC00408-RI
27107629524	27105A371F1; 27105A371F3	TC00408-RI
27107636174	27105A371F1; 27105A371F3	TC00408-RI
27107636178	27105A371F0; 27105A371F2	TC00414-RI
27107636485	27105A371F0; 27105A371F2	TC00414-RI
27107636486	27105A371F1; 27105A371F3	TC00408-RI
27107639262	27105A371F0; 27105A371F2	TC00414-RI
27107639263	27105A371F1; 27105A371F3	TC00408-RI
27107643756	27105A371F0; 27105A371F2	TC00414-RI
27107643757	27105A371F1; 27105A371F3	TC00408-RI
27107649718	27105A371F1; 27105A371F3	TC00408-RI
27107649725	27105A371F0; 27105A371F2	TC00414-RI
27107649782	27105A371F0; 27105A371F2	TC00414-RI
27107649783	27105A371F1; 27105A371F3	TC00408-RI
27108604768	27105A371F0; 27105A371F2	TC00414-RI
27108604769	27105A371F1; 27105A371F3	TC00408-RI
27108612556	27105A371F0; 27105A371F2	TC00414-RI
27108612557	27105A371F1; 27105A371F3	TC00408-RI
27108623346	27105A371F0; 27105A371F2	TC00414-RI
27108623347	27105A371F1; 27105A371F3	TC00408-RI
27108643149	27105A371F0; 27105A371F2	TC00414-RI
27108643150	27105A371F1; 27105A371F3	TC00408-RI
27108662300	27105A371F0; 27105A371F2	TC00414-RI
27108662968	27105A371F1; 27105A371F3	TC00408-RI

### BMW - 2

#### Gearbox, Powertrain - Transfer Case

OEM no	Successor no	Part number
27104603370	27105A371F1; 27105A371F3	TC00408-RI
27105A371F0		TC00414-RI
27105A371F1		TC00408-RI
27105A371F2		TC00414-RI

All rights reserved.

This publication may not be reproduced in any form, in whole or in part, without a written approval from S-TEC Service Technologies GmbH & Co OG.  
Subject to change without notice!

### Brand - Series

### Maingroup - Subgroup

### BMW - 2

#### Gearbox, Powertrain - Transfer Case

OEM no	Successor no	Part number
27105A371F3		TC00408-RI
27107505374	27105A371F0; 27105A371F2	TC00414-RI
27107505375	27105A371F1; 27105A371F3	TC00408-RI
27107617503	27105A371F0; 27105A371F2	TC00414-RI
27107622018	27105A371F0; 27105A371F2	TC00414-RI
27107629172	27105A371F0; 27105A371F2	TC00414-RI
27107629176	27105A371F0; 27105A371F2	TC00414-RI
27107629521	27105A371F1; 27105A371F3	TC00408-RI
27107629524	27105A371F1; 27105A371F3	TC00408-RI
27107636174	27105A371F1; 27105A371F3	TC00408-RI
27107636178	27105A371F0; 27105A371F2	TC00414-RI
27107636485	27105A371F0; 27105A371F2	TC00414-RI
27107636486	27105A371F1; 27105A371F3	TC00408-RI
27107639262	27105A371F0; 27105A371F2	TC00414-RI
27107639263	27105A371F1; 27105A371F3	TC00408-RI
27107643756	27105A371F0; 27105A371F2	TC00414-RI
27107643757	27105A371F1; 27105A371F3	TC00408-RI
27107649718	27105A371F1; 27105A371F3	TC00408-RI
27107649725	27105A371F0; 27105A371F2	TC00414-RI
27107649782	27105A371F0; 27105A371F2	TC00414-RI
27107649783	27105A371F1; 27105A371F3	TC00408-RI
27108604768	27105A371F0; 27105A371F2	TC00414-RI
27108604769	27105A371F1; 27105A371F3	TC00408-RI
27108612556	27105A371F0; 27105A371F2	TC00414-RI
27108612557	27105A371F1; 27105A371F3	TC00408-RI
27108623346	27105A371F0; 27105A371F2	TC00414-RI
27108623347	27105A371F1; 27105A371F3	TC00408-RI
27108643149	27105A371F0; 27105A371F2	TC00414-RI
27108643150	27105A371F1; 27105A371F3	TC00408-RI
27108662300	27105A371F0; 27105A371F2	TC00414-RI
27108662968	27105A371F1; 27105A371F3	TC00408-RI

### BMW - 3

#### Gearbox, Powertrain - Transfer Case

OEM no	Successor no	Part number
27102385073	27108465870; 27108686667	TC00555-RI
27104603370	27105A371F1; 27105A371F3	TC00408-RI
27105A371F0		TC00414-RI
27105A371F1		TC00408-RI
27105A371F2		TC00414-RI
27105A371F3		TC00408-RI
27107505374	27105A371F0; 27105A371F2	TC00414-RI
27107505375	27105A371F1; 27105A371F3	TC00408-RI

All rights reserved.

This publication may not be reproduced in any form, in whole or in part, without a written approval from S-TEC Service Technologies GmbH & Co OG.  
Subject to change without notice!



### Brand - Series

### Maingroup - Subgroup

### BMW - 3

### Gearbox, Powertrain - Transfer Case

OEM no	Successor no	Part number
27107546677	27107599690; 27107599693	TC00035-RI
27107548666	27107599690; 27107599693	TC00035-RI
27107549030	27107599690; 27107599693	TC00035-RI
27107552701	27107599690; 27107599693	TC00035-RI
27107599690		TC00035-RI
27107599691	27107599690; 27107599693	TC00035-RI
27107599693		TC00035-RI
27107613152		TC00285-RI
27107613153		TC00285-RI
27107617503	27105A371F0; 27105A371F2	TC00414-RI
27107622018	27105A371F0; 27105A371F2	TC00414-RI
27107629172	27105A371F0; 27105A371F2	TC00414-RI
27107629176	27105A371F0; 27105A371F2	TC00414-RI
27107629521	27105A371F1; 27105A371F3	TC00408-RI
27107629524	27105A371F1; 27105A371F3	TC00408-RI
27107636174	27105A371F1; 27105A371F3	TC00408-RI
27107636178	27105A371F0; 27105A371F2	TC00414-RI
27107636485	27105A371F0; 27105A371F2	TC00414-RI
27107636486	27105A371F1; 27105A371F3	TC00408-RI
27107639262	27105A371F0; 27105A371F2	TC00414-RI
27107639263	27105A371F1; 27105A371F3	TC00408-RI
27107643756	27105A371F0; 27105A371F2	TC00414-RI
27107643757	27105A371F1; 27105A371F3	TC00408-RI
27107649718	27105A371F1; 27105A371F3	TC00408-RI
27107649725	27105A371F0; 27105A371F2	TC00414-RI
27107649782	27105A371F0; 27105A371F2	TC00414-RI
27107649783	27105A371F1; 27105A371F3	TC00408-RI
27107889033	27108465870; 27108686667	TC00555-RI
27108465870		TC00555-RI
27108485037	27108465870; 27108686667	TC00555-RI
27108485602	27108465870; 27108686667	TC00555-RI
27108487143	27108465870; 27108686667	TC00555-RI
27108604768	27105A371F0; 27105A371F2	TC00414-RI
27108604769	27105A371F1; 27105A371F3	TC00408-RI
27108612556	27105A371F0; 27105A371F2	TC00414-RI
27108612557	27105A371F1; 27105A371F3	TC00408-RI
2710862144	27108465870; 27108686667	TC00555-RI
27108623346	27105A371F0; 27105A371F2	TC00414-RI
27108623347	27105A371F1; 27105A371F3	TC00408-RI
27108638719	27108465870; 27108686667	TC00555-RI
27108643149	27105A371F0; 27105A371F2	TC00414-RI
27108643150	27105A371F1; 27105A371F3	TC00408-RI
27108649053	27108465870; 27108686667	TC00555-RI
27108655148	27108465870; 27108686667	TC00555-RI

All rights reserved.

This publication may not be reproduced in any form, in whole or in part, without a written approval from S-TEC Service Technologies GmbH & Co OG.  
Subject to change without notice!

### Brand - Series

### Maingroup - Subgroup

### BMW - 3

#### Gearbox, Powertrain - Transfer Case

OEM no	Successor no	Part number
27108656295	27108465870; 27108686667	TC00555-RI
27108662300	27105A371F0; 27105A371F2	TC00414-RI
27108662968	27105A371F1; 27105A371F3	TC00408-RI
27108663655	27108465870; 27108686667	TC00555-RI
27108664091	27108465870; 27108686667	TC00555-RI
27108670280	27108465870; 27108686667	TC00555-RI
27108670282	27108465870; 27108686667	TC00555-RI
27108673168	27108465870; 27108686667	TC00555-RI
27108673712	27108465870; 27108686667	TC00555-RI
27108673713	27108465870; 27108686667	TC00555-RI
27108677684	27108465870; 27108686667	TC00555-RI
27108677687	27108465870; 27108686667	TC00555-RI
27108678470	27108465870; 27108686667	TC00555-RI
27108678472	27108465870; 27108686667	TC00555-RI
27108684857	27108465870; 27108686667	TC00555-RI
27108684859	27108465870; 27108686667	TC00555-RI
27108686667		TC00555-RI
27108687370	27108465870; 27108686667	TC00555-RI
27108697722	27108465870; 27108686667	TC00555-RI
27108740625	27108465870; 27108686667	TC00555-RI
27109469019	27108465870; 27108686667	TC00555-RI
27109470187	27108465870; 27108686667	TC00555-RI
27109895299	27108465870; 27108686667	TC00555-RI

### BMW - 4

#### Gearbox, Powertrain - Transfer Case

OEM no	Successor no	Part number
27104603370	27105A371F1; 27105A371F3	TC00408-RI
27105A371F0		TC00414-RI
27105A371F1		TC00408-RI
27105A371F2		TC00414-RI
27105A371F3		TC00408-RI
27107505374	27105A371F0; 27105A371F2	TC00414-RI
27107505375	27105A371F1; 27105A371F3	TC00408-RI
27107617503	27105A371F0; 27105A371F2	TC00414-RI
27107622018	27105A371F0; 27105A371F2	TC00414-RI
27107629172	27105A371F0; 27105A371F2	TC00414-RI
27107629176	27105A371F0; 27105A371F2	TC00414-RI
27107629521	27105A371F1; 27105A371F3	TC00408-RI
27107629524	27105A371F1; 27105A371F3	TC00408-RI
27107636174	27105A371F1; 27105A371F3	TC00408-RI
27107636178	27105A371F0; 27105A371F2	TC00414-RI
27107636485	27105A371F0; 27105A371F2	TC00414-RI

All rights reserved.

This publication may not be reproduced in any form, in whole or in part, without a written approval from S-TEC Service Technologies GmbH & Co OG.  
Subject to change without notice!

### Brand - Series

### Maingroup - Subgroup

### BMW - 4

#### Gearbox, Powertrain - Transfer Case

OEM no	Successor no	Part number
27107636486	27105A371F1; 27105A371F3	TC00408-RI
27107639262	27105A371F0; 27105A371F2	TC00414-RI
27107639263	27105A371F1; 27105A371F3	TC00408-RI
27107643756	27105A371F0; 27105A371F2	TC00414-RI
27107643757	27105A371F1; 27105A371F3	TC00408-RI
27107649718	27105A371F1; 27105A371F3	TC00408-RI
27107649725	27105A371F0; 27105A371F2	TC00414-RI
27107649782	27105A371F0; 27105A371F2	TC00414-RI
27107649783	27105A371F1; 27105A371F3	TC00408-RI
27108604768	27105A371F0; 27105A371F2	TC00414-RI
27108604769	27105A371F1; 27105A371F3	TC00408-RI
27108612556	27105A371F0; 27105A371F2	TC00414-RI
27108612557	27105A371F1; 27105A371F3	TC00408-RI
27108623346	27105A371F0; 27105A371F2	TC00414-RI
27108623347	27105A371F1; 27105A371F3	TC00408-RI
27108643149	27105A371F0; 27105A371F2	TC00414-RI
27108643150	27105A371F1; 27105A371F3	TC00408-RI
27108662300	27105A371F0; 27105A371F2	TC00414-RI
27108662968	27105A371F1; 27105A371F3	TC00408-RI

### BMW - 5

#### Gearbox, Powertrain - Transfer Case

OEM no	Successor no	Part number
27102385073	27108465870; 27108686667	TC00555-RI
27102385074	27108465871; 27108686666	TC00556-RI
27104603370	27105A371F1; 27105A371F3	TC00408-RI
27105A371E7		TC00267-RI
27105A371F0		TC00414-RI
27105A371F1		TC00408-RI
27105A371F2		TC00414-RI
27105A371F3		TC00408-RI
27107505374	27105A371F0; 27105A371F2	TC00414-RI
27107505375	27105A371F1; 27105A371F3	TC00408-RI
27107546677	27107599690; 27107599693	TC00035-RI
27107548666	27107599690; 27107599693	TC00035-RI
27107549030	27107599690; 27107599693	TC00035-RI
27107552701	27107599690; 27107599693	TC00035-RI
27107599690		TC00035-RI
27107599691	27107599690; 27107599693	TC00035-RI
27107599693		TC00035-RI
27107605406	27105A371E7	TC00267-RI
27107609191	27105A371E7	TC00267-RI
27107610582	27105A371E7	TC00267-RI

All rights reserved.

This publication may not be reproduced in any form, in whole or in part, without a written approval from S-TEC Service Technologies GmbH & Co OG.  
Subject to change without notice!

### Brand - Series

### Maingroup - Subgroup

### BMW - 5

### Gearbox, Powertrain - Transfer Case

OEM no	Successor no	Part number
27107617503	27105A371F0; 27105A371F2	TC00414-RI
27107619177	27105A371E7	TC00267-RI
27107619777	27105A371E7	TC00267-RI
27107622018	27105A371F0; 27105A371F2	TC00414-RI
27107629172	27105A371F0; 27105A371F2	TC00414-RI
27107629176	27105A371F0; 27105A371F2	TC00414-RI
27107629521	27105A371F1; 27105A371F3	TC00408-RI
27107629524	27105A371F1; 27105A371F3	TC00408-RI
27107629604	27105A371E7	TC00267-RI
27107636172	27105A371E7	TC00267-RI
27107636174	27105A371F1; 27105A371F3	TC00408-RI
27107636178	27105A371F0; 27105A371F2	TC00414-RI
27107636479	27105A371E7	TC00267-RI
27107636485	27105A371F0; 27105A371F2	TC00414-RI
27107636486	27105A371F1; 27105A371F3	TC00408-RI
27107639260	27105A371E7	TC00267-RI
27107639262	27105A371F0; 27105A371F2	TC00414-RI
27107639263	27105A371F1; 27105A371F3	TC00408-RI
27107643750	27105A371E7	TC00267-RI
27107643756	27105A371F0; 27105A371F2	TC00414-RI
27107643757	27105A371F1; 27105A371F3	TC00408-RI
27107649718	27105A371F1; 27105A371F3	TC00408-RI
27107649725	27105A371F0; 27105A371F2	TC00414-RI
27107649782	27105A371F0; 27105A371F2	TC00414-RI
27107649783	27105A371F1; 27105A371F3	TC00408-RI
27107889033	27108465870; 27108686667	TC00555-RI
27107889034	27108465871; 27108686666	TC00556-RI
27108089528	27108747764	TC00557-RI
27108092621	27108747764	TC00557-RI
27108098422	27108747764	TC00557-RI
27108465870		TC00555-RI
27108465871		TC00556-RI
27108485037	27108465870; 27108686667	TC00555-RI
	27108465871; 27108686666	TC00556-RI
27108485602	27108465870; 27108686667	TC00555-RI
27108486042	27108465871; 27108686666	TC00556-RI
27108487143	27108465870; 27108686667	TC00555-RI
27108487144	27108465871; 27108686666	TC00556-RI
27108604768	27105A371F0; 27105A371F2	TC00414-RI
27108604769	27105A371F1; 27105A371F3	TC00408-RI
27108612556	27105A371F0; 27105A371F2	TC00414-RI
27108612557	27105A371F1; 27105A371F3	TC00408-RI
2710862144	27108465870; 27108686667	TC00555-RI
27108623346	27105A371F0; 27105A371F2	TC00414-RI

All rights reserved.

This publication may not be reproduced in any form, in whole or in part, without a written approval from S-TEC Service Technologies GmbH & Co OG.  
Subject to change without notice!

# 4WD Systems References

## 2025

### Brand - Series

### Maingroup - Subgroup

### BMW - 5

### Gearbox, Powertrain - Transfer Case

OEM no	Successor no	Part number
27108623347	27105A371F1; 27105A371F3	TC00408-RI
27108638719	27108465870; 27108686667	TC00555-RI
27108638720	27108465871; 27108686666	TC00556-RI
27108643149	27105A371F0; 27105A371F2	TC00414-RI
27108643150	27105A371F1; 27105A371F3	TC00408-RI
27108649053	27108465870; 27108686667	TC00555-RI
27108649060	27108465871; 27108686666	TC00556-RI
27108652145	27108465871; 27108686666	TC00556-RI
27108655148	27108465870; 27108686667	TC00555-RI
27108655149	27108465871; 27108686666	TC00556-RI
27108656295	27108465870; 27108686667	TC00555-RI
27108656296	27108465871; 27108686666	TC00556-RI
27108662300	27105A371F0; 27105A371F2	TC00414-RI
27108662968	27105A371F1; 27105A371F3	TC00408-RI
27108663654	27108465871; 27108686666	TC00556-RI
27108663655	27108465870; 27108686667	TC00555-RI
27108664091	27108465870; 27108686667	TC00555-RI
27108670280	27108465870; 27108686667	TC00555-RI
27108670281	27108465871; 27108686666	TC00556-RI
27108670282	27108465870; 27108686667	TC00555-RI
27108670283	27108465871; 27108686666	TC00556-RI
27108673168	27108465870; 27108686667	TC00555-RI
27108673711	27108465871; 27108686666	TC00556-RI
27108673712	27108465870; 27108686667	TC00555-RI
27108673713	27108465870; 27108686667	TC00555-RI
27108673714	27108465871; 27108686666	TC00556-RI
27108677684	27108465870; 27108686667	TC00555-RI
27108677685	27108465871; 27108686666	TC00556-RI
27108677686	27108465871; 27108686666	TC00556-RI
27108677687	27108465870; 27108686667	TC00555-RI
27108678470	27108465870; 27108686667	TC00555-RI
27108678471	27108465871; 27108686666	TC00556-RI
27108678472	27108465870; 27108686667	TC00555-RI
27108678473	27108465871; 27108686666	TC00556-RI
27108680317	27108465871; 27108686666	TC00556-RI
27108680318	27108465871; 27108686666	TC00556-RI
27108684857	27108465870; 27108686667	TC00555-RI
27108684858	27108465871; 27108686666	TC00556-RI
27108684859	27108465870; 27108686667	TC00555-RI
27108684860	27108465871; 27108686666	TC00556-RI
27108686666		TC00556-RI
27108686667		TC00555-RI
27108687370	27108465870; 27108686667	TC00555-RI
27108689416	27108465871; 27108686666	TC00556-RI

All rights reserved.

This publication may not be reproduced in any form, in whole or in part, without a written approval from S-TEC Service Technologies GmbH & Co OG.  
Subject to change without notice!

### Brand - Series

### Maingroup - Subgroup

### BMW - 5

#### Gearbox, Powertrain - Transfer Case

OEM no	Successor no	Part number
27108697721	27108465871; 27108686666	TC00556-RI
27108697722	27108465870; 27108686667	TC00555-RI
27108697723	27108465871; 27108686666	TC00556-RI
27108697978	27105A371E7	TC00267-RI
27108740625	27108465870; 27108686667	TC00555-RI
27108740626	27108465871; 27108686666	TC00556-RI
27108747764		TC00557-RI
27109469019	27108465870; 27108686667	TC00555-RI
27109469020	27108465871; 27108686666	TC00556-RI
27109470187	27108465870; 27108686667	TC00555-RI
27109470188	27108465871; 27108686666	TC00556-RI
27109895299	27108465870; 27108686667	TC00555-RI
27109895300	27108465871; 27108686666	TC00556-RI

### BMW - 6

#### Gearbox, Powertrain - Transfer Case

OEM no	Successor no	Part number
27102385073	27108465870; 27108686667	TC00555-RI
27105A371F0		TC00414-RI
27105A371F2		TC00414-RI
27107505374	27105A371F0; 27105A371F2	TC00414-RI
27107617503	27105A371F0; 27105A371F2	TC00414-RI
27107622018	27105A371F0; 27105A371F2	TC00414-RI
27107629172	27105A371F0; 27105A371F2	TC00414-RI
27107629176	27105A371F0; 27105A371F2	TC00414-RI
27107636178	27105A371F0; 27105A371F2	TC00414-RI
27107636485	27105A371F0; 27105A371F2	TC00414-RI
27107639262	27105A371F0; 27105A371F2	TC00414-RI
27107643756	27105A371F0; 27105A371F2	TC00414-RI
27107649725	27105A371F0; 27105A371F2	TC00414-RI
27107649782	27105A371F0; 27105A371F2	TC00414-RI
27107889033	27108465870; 27108686667	TC00555-RI
27108465870		TC00555-RI
27108485037	27108465870; 27108686667	TC00555-RI
27108485602	27108465870; 27108686667	TC00555-RI
27108487143	27108465870; 27108686667	TC00555-RI
27108604768	27105A371F0; 27105A371F2	TC00414-RI
27108612556	27105A371F0; 27105A371F2	TC00414-RI
2710862144	27108465870; 27108686667	TC00555-RI
27108623346	27105A371F0; 27105A371F2	TC00414-RI
27108638719	27108465870; 27108686667	TC00555-RI
27108643149	27105A371F0; 27105A371F2	TC00414-RI
27108649053	27108465870; 27108686667	TC00555-RI

All rights reserved.

This publication may not be reproduced in any form, in whole or in part, without a written approval from S-TEC Service Technologies GmbH & Co OG.  
Subject to change without notice!

### Brand - Series

### Maingroup - Subgroup

### BMW - 6

#### Gearbox, Powertrain - Transfer Case

OEM no	Successor no	Part number
27108655148	27108465870; 27108686667	TC00555-RI
27108656295	27108465870; 27108686667	TC00555-RI
27108662300	27105A371F0; 27105A371F2	TC00414-RI
27108663655	27108465870; 27108686667	TC00555-RI
27108664091	27108465870; 27108686667	TC00555-RI
27108670280	27108465870; 27108686667	TC00555-RI
27108670282	27108465870; 27108686667	TC00555-RI
27108673168	27108465870; 27108686667	TC00555-RI
27108673712	27108465870; 27108686667	TC00555-RI
27108673713	27108465870; 27108686667	TC00555-RI
27108677684	27108465870; 27108686667	TC00555-RI
27108677687	27108465870; 27108686667	TC00555-RI
27108678470	27108465870; 27108686667	TC00555-RI
27108678472	27108465870; 27108686667	TC00555-RI
27108684857	27108465870; 27108686667	TC00555-RI
27108684859	27108465870; 27108686667	TC00555-RI
27108686667		TC00555-RI
27108687370	27108465870; 27108686667	TC00555-RI
27108697722	27108465870; 27108686667	TC00555-RI
27108740625	27108465870; 27108686667	TC00555-RI
27109469019	27108465870; 27108686667	TC00555-RI
27109470187	27108465870; 27108686667	TC00555-RI
27109895299	27108465870; 27108686667	TC00555-RI

### BMW - 7

#### Gearbox, Powertrain - Transfer Case

OEM no	Successor no	Part number
27102385073	27108465870; 27108686667	TC00555-RI
27102385074	27108465871; 27108686666	TC00556-RI
27105A371E7		TC00267-RI
27105A371F0		TC00414-RI
27105A371F2		TC00414-RI
27107505374	27105A371F0; 27105A371F2	TC00414-RI
27107605406	27105A371E7	TC00267-RI
27107609191	27105A371E7	TC00267-RI
27107610582	27105A371E7	TC00267-RI
27107617503	27105A371F0; 27105A371F2	TC00414-RI
27107619177	27105A371E7	TC00267-RI
27107619777	27105A371E7	TC00267-RI
27107622018	27105A371F0; 27105A371F2	TC00414-RI
27107629172	27105A371F0; 27105A371F2	TC00414-RI
27107629176	27105A371F0; 27105A371F2	TC00414-RI
27107629604	27105A371E7	TC00267-RI

All rights reserved.

This publication may not be reproduced in any form, in whole or in part, without a written approval from S-TEC Service Technologies GmbH & Co OG.  
Subject to change without notice!

# 4WD Systems References

## 2025

### Brand - Series

### Maingroup - Subgroup

### BMW - 7

### Gearbox, Powertrain - Transfer Case

OEM no	Successor no	Part number
27107636172	27105A371E7	TC00267-RI
27107636178	27105A371F0; 27105A371F2	TC00414-RI
27107636479	27105A371E7	TC00267-RI
27107636485	27105A371F0; 27105A371F2	TC00414-RI
27107639260	27105A371E7	TC00267-RI
27107639262	27105A371F0; 27105A371F2	TC00414-RI
27107643750	27105A371E7	TC00267-RI
27107643756	27105A371F0; 27105A371F2	TC00414-RI
27107649725	27105A371F0; 27105A371F2	TC00414-RI
27107649782	27105A371F0; 27105A371F2	TC00414-RI
27107889033	27108465870; 27108686667	TC00555-RI
27107889034	27108465871; 27108686666	TC00556-RI
27108465870		TC00555-RI
27108465871		TC00556-RI
27108485037	27108465870; 27108686667 27108465871; 27108686666	TC00555-RI TC00556-RI
27108485602	27108465870; 27108686667	TC00555-RI
27108486042	27108465871; 27108686666	TC00556-RI
27108487143	27108465870; 27108686667	TC00555-RI
27108487144	27108465871; 27108686666	TC00556-RI
27108604768	27105A371F0; 27105A371F2	TC00414-RI
27108612556	27105A371F0; 27105A371F2	TC00414-RI
2710862144	27108465870; 27108686667	TC00555-RI
27108623346	27105A371F0; 27105A371F2	TC00414-RI
27108638719	27108465870; 27108686667	TC00555-RI
27108638720	27108465871; 27108686666	TC00556-RI
27108643149	27105A371F0; 27105A371F2	TC00414-RI
27108649053	27108465870; 27108686667	TC00555-RI
27108649060	27108465871; 27108686666	TC00556-RI
27108652145	27108465871; 27108686666	TC00556-RI
27108655148	27108465870; 27108686667	TC00555-RI
27108655149	27108465871; 27108686666	TC00556-RI
27108656295	27108465870; 27108686667	TC00555-RI
27108656296	27108465871; 27108686666	TC00556-RI
27108662300	27105A371F0; 27105A371F2	TC00414-RI
27108663654	27108465871; 27108686666	TC00556-RI
27108663655	27108465870; 27108686667	TC00555-RI
27108664091	27108465870; 27108686667	TC00555-RI
27108670280	27108465870; 27108686667	TC00555-RI
27108670281	27108465871; 27108686666	TC00556-RI
27108670282	27108465870; 27108686667	TC00555-RI
27108670283	27108465871; 27108686666	TC00556-RI
27108673168	27108465870; 27108686667	TC00555-RI
27108673711	27108465871; 27108686666	TC00556-RI

All rights reserved.

This publication may not be reproduced in any form, in whole or in part, without a written approval from S-TEC Service Technologies GmbH & Co OG.  
Subject to change without notice!



### Brand - Series

### Maingroup - Subgroup

### BMW - 7

#### Gearbox, Powertrain - Transfer Case

OEM no	Successor no	Part number
27108673712	27108465870; 27108686667	TC00555-RI
27108673713	27108465870; 27108686667	TC00555-RI
27108673714	27108465871; 27108686666	TC00556-RI
27108677684	27108465870; 27108686667	TC00555-RI
27108677685	27108465871; 27108686666	TC00556-RI
27108677686	27108465871; 27108686666	TC00556-RI
27108677687	27108465870; 27108686667	TC00555-RI
27108678470	27108465870; 27108686667	TC00555-RI
27108678471	27108465871; 27108686666	TC00556-RI
27108678472	27108465870; 27108686667	TC00555-RI
27108678473	27108465871; 27108686666	TC00556-RI
27108680317	27108465871; 27108686666	TC00556-RI
27108680318	27108465871; 27108686666	TC00556-RI
27108684857	27108465870; 27108686667	TC00555-RI
27108684858	27108465871; 27108686666	TC00556-RI
27108684859	27108465870; 27108686667	TC00555-RI
27108684860	27108465871; 27108686666	TC00556-RI
27108686666		TC00556-RI
27108686667		TC00555-RI
27108687370	27108465870; 27108686667	TC00555-RI
27108689416	27108465871; 27108686666	TC00556-RI
27108697721	27108465871; 27108686666	TC00556-RI
27108697722	27108465870; 27108686667	TC00555-RI
27108697723	27108465871; 27108686666	TC00556-RI
27108697978	27105A371E7	TC00267-RI
27108740625	27108465870; 27108686667	TC00555-RI
27108740626	27108465871; 27108686666	TC00556-RI
27109469019	27108465870; 27108686667	TC00555-RI
27109469020	27108465871; 27108686666	TC00556-RI
27109470187	27108465870; 27108686667	TC00555-RI
27109470188	27108465871; 27108686666	TC00556-RI
27109895299	27108465870; 27108686667	TC00555-RI
27109895300	27108465871; 27108686666	TC00556-RI

### BMW - 8

#### Gearbox, Powertrain - Transfer Case

OEM no	Successor no	Part number
27102385073	27108465870; 27108686667	TC00555-RI
27102385074	27108465871; 27108686666	TC00556-RI
27107889033	27108465870; 27108686667	TC00555-RI
27107889034	27108465871; 27108686666	TC00556-RI
27108089528	27108747764	TC00557-RI
27108092621	27108747764	TC00557-RI

All rights reserved.

This publication may not be reproduced in any form, in whole or in part, without a written approval from S-TEC Service Technologies GmbH & Co OG.  
Subject to change without notice!

# 4WD Systems References

## 2025

### Brand - Series

### Maingroup - Subgroup

### BMW - 8

### Gearbox, Powertrain - Transfer Case

OEM no	Successor no	Part number
27108098422	27108747764	TC00557-RI
27108465870		TC00555-RI
27108465871		TC00556-RI
27108485037	27108465870; 27108686667	TC00555-RI
	27108465871; 27108686666	TC00556-RI
27108485602	27108465870; 27108686667	TC00555-RI
27108486042	27108465871; 27108686666	TC00556-RI
27108487143	27108465870; 27108686667	TC00555-RI
27108487144	27108465871; 27108686666	TC00556-RI
2710862144	27108465870; 27108686667	TC00555-RI
27108638719	27108465870; 27108686667	TC00555-RI
27108638720	27108465871; 27108686666	TC00556-RI
27108649053	27108465870; 27108686667	TC00555-RI
27108649060	27108465871; 27108686666	TC00556-RI
27108652145	27108465871; 27108686666	TC00556-RI
27108655148	27108465870; 27108686667	TC00555-RI
27108655149	27108465871; 27108686666	TC00556-RI
27108656295	27108465870; 27108686667	TC00555-RI
27108656296	27108465871; 27108686666	TC00556-RI
27108663654	27108465871; 27108686666	TC00556-RI
27108663655	27108465870; 27108686667	TC00555-RI
27108664091	27108465870; 27108686667	TC00555-RI
27108670280	27108465870; 27108686667	TC00555-RI
27108670281	27108465871; 27108686666	TC00556-RI
27108670282	27108465870; 27108686667	TC00555-RI
27108670283	27108465871; 27108686666	TC00556-RI
27108673168	27108465870; 27108686667	TC00555-RI
27108673711	27108465871; 27108686666	TC00556-RI
27108673712	27108465870; 27108686667	TC00555-RI
27108673713	27108465870; 27108686667	TC00555-RI
27108673714	27108465871; 27108686666	TC00556-RI
27108677684	27108465870; 27108686667	TC00555-RI
27108677685	27108465871; 27108686666	TC00556-RI
27108677686	27108465871; 27108686666	TC00556-RI
27108677687	27108465870; 27108686667	TC00555-RI
27108678470	27108465870; 27108686667	TC00555-RI
27108678471	27108465871; 27108686666	TC00556-RI
27108678472	27108465870; 27108686667	TC00555-RI
27108678473	27108465871; 27108686666	TC00556-RI
27108680317	27108465871; 27108686666	TC00556-RI
27108680318	27108465871; 27108686666	TC00556-RI
27108684857	27108465870; 27108686667	TC00555-RI
27108684858	27108465871; 27108686666	TC00556-RI
27108684859	27108465870; 27108686667	TC00555-RI

All rights reserved.

This publication may not be reproduced in any form, in whole or in part, without a written approval from S-TEC Service Technologies GmbH & Co OG.  
Subject to change without notice!

### Brand - Series

### Maingroup - Subgroup

### BMW - 8

#### Gearbox, Powertrain - Transfer Case

OEM no	Successor no	Part number
27108684860	27108465871; 27108686666	TC00556-RI
27108686666		TC00556-RI
27108686667		TC00555-RI
27108687370	27108465870; 27108686667	TC00555-RI
27108689416	27108465871; 27108686666	TC00556-RI
27108697721	27108465871; 27108686666	TC00556-RI
27108697722	27108465870; 27108686667	TC00555-RI
27108697723	27108465871; 27108686666	TC00556-RI
27108740625	27108465870; 27108686667	TC00555-RI
27108740626	27108465871; 27108686666	TC00556-RI
27108747764		TC00557-RI
27109469019	27108465870; 27108686667	TC00555-RI
27109469020	27108465871; 27108686666	TC00556-RI
27109470187	27108465870; 27108686667	TC00555-RI
27109470188	27108465871; 27108686666	TC00556-RI
27109895299	27108465870; 27108686667	TC00555-RI
27109895300	27108465871; 27108686666	TC00556-RI

### BMW - X1

#### Gearbox, Powertrain - Transfer Case

OEM no	Successor no	Part number
27105A371E5		TC00266-RI
27105A371E6		TC00394-RI
27105A371E8		TC00413-RI
27105A371E9		TC00410-RI
27107607638	27105A371E5	TC00266-RI
27107609194	27105A371E5	TC00266-RI
27107610584	27105A371E5	TC00266-RI
27107619176	27105A371E5	TC00266-RI
27107619643	27105A371E8	TC00413-RI
27107619928	27105A371E6	TC00394-RI
27107621378	27105A371E8	TC00413-RI
27107629175	27105A371E8	TC00413-RI
27107629349	27105A371E9	TC00410-RI
27107629523	27105A371E9	TC00410-RI
27107631536	27105A371E9	TC00410-RI
27107635755	27105A371E5	TC00266-RI
27107635756	27105A371E6	TC00394-RI
27107635757	27105A371E8	TC00413-RI
27107635758	27105A371E9	TC00410-RI
27107636477	27105A371E5	TC00266-RI
27107636478	27105A371E6	TC00394-RI
27107636483	27105A371E8	TC00413-RI

All rights reserved.

This publication may not be reproduced in any form, in whole or in part, without a written approval from S-TEC Service Technologies GmbH & Co OG.  
Subject to change without notice!

### Brand - Series

### Maingroup - Subgroup

### BMW - X1

#### Gearbox, Powertrain - Transfer Case

OEM no	Successor no	Part number
27107636484	27105A371E9	TC00410-RI
27107639266	27105A371E5	TC00266-RI
27107639268	27105A371E6	TC00394-RI
27107639269	27105A371E8	TC00413-RI
27107639270	27105A371E9	TC00410-RI
27107643748	27105A371E5	TC00266-RI
27107643749	27105A371E6	TC00394-RI
27107643754	27105A371E8	TC00413-RI
27107643755	27105A371E9	TC00410-RI
27107649181	27105A371E9	TC00410-RI
27108697975	27105A371E8	TC00413-RI
27108697976	27105A371E5	TC00266-RI
27108697977	27105A371E6	TC00394-RI

### BMW - X3

#### Gearbox, Powertrain - Transfer Case

OEM no	Successor no	Part number
27100362791	27103455133; 27103455134; 27103455139	TC00037-RI
27102385073	27108465870; 27108686667	TC00555-RI
27103424081	27103455138	TC00061-RI
27103427762	27103455138	TC00061-RI
27103428186	27103455133; 27103455134; 27103455139	TC00037-RI
27103434169	27103455135; 27103455136; 27103455137	TC00038-RI
27103434267	27103455135; 27103455136; 27103455137	TC00038-RI
27103435185	27103455133; 27103455134; 27103455139	TC00037-RI
27103435186	27103455135; 27103455136; 27103455137	TC00038-RI
27103435187	27103455135; 27103455136; 27103455137	TC00038-RI
27103455131		TC00256-RI
27103455132	27103455131	TC00256-RI
27103455133		TC00037-RI
27103455134		TC00037-RI
27103455135		TC00038-RI
27103455136		TC00038-RI
27103455137		TC00038-RI
27103455138		TC00061-RI
27103455139		TC00037-RI
27105A371D9		TC00399-RI
27105A371E2		TC00401-RI
27105A4A0C1		TC00401-RI

All rights reserved.

This publication may not be reproduced in any form, in whole or in part, without a written approval from S-TEC Service Technologies GmbH & Co OG.  
Subject to change without notice!

### Brand - Series

### Maingroup - Subgroup

### BMW - X3

### Gearbox, Powertrain - Transfer Case

OEM no	Successor no	Part number
27107505376	27105A371E2; 27105A4A0C1	TC00401-RI
27107526278	27103455133; 27103455134; 27103455139	TC00037-RI
27107535865	27103455133; 27103455134; 27103455139	TC00037-RI
27107545710	27103455133; 27103455134; 27103455139	TC00037-RI
27107546816	27103455133; 27103455134; 27103455139	TC00037-RI
27107555293	27103455133; 27103455134; 27103455139	TC00037-RI
27107555294	27103455133; 27103455134; 27103455139	TC00037-RI
27107555296	27103455133; 27103455134; 27103455139	TC00037-RI
27107567845	27103455131	TC00256-RI
27107567846	27103455131	TC00256-RI
27107573213	27103455133; 27103455134; 27103455139	TC00037-RI
27107573214	27103455133; 27103455134; 27103455139	TC00037-RI
27107573215	27103455135; 27103455136; 27103455137	TC00038-RI
27107573216	27103455135; 27103455136; 27103455137	TC00038-RI
27107573217	27103455135; 27103455136; 27103455137	TC00038-RI
27107573218	27103455135; 27103455136; 27103455137	TC00038-RI
27107573221	27103455138	TC00061-RI
27107573222	27103455133; 27103455134; 27103455139	TC00037-RI
27107609193	27105A371D9	TC00399-RI
27107610588	27105A371D9	TC00399-RI
27107619180	27105A371D9	TC00399-RI
27107619646	27105A371E2; 27105A4A0C1	TC00401-RI
27107619776	27105A371D9	TC00399-RI
27107629179	27105A371E2; 27105A4A0C1	TC00401-RI
27107636180	27105A371E2; 27105A4A0C1	TC00401-RI
27107636482	27105A371D9	TC00399-RI
27107636489	27105A371E2; 27105A4A0C1	TC00401-RI
27107639264	27105A371D9	TC00399-RI
27107639265	27105A371E2; 27105A4A0C1	TC00401-RI
27107643753	27105A371D9	TC00399-RI
27107643760	27105A371E2; 27105A4A0C1	TC00401-RI
27107649784	27105A371E2; 27105A4A0C1	TC00401-RI
27107889033	27108465870; 27108686667	TC00555-RI
27108089528	27108747764	TC00557-RI
27108092621	27108747764	TC00557-RI
27108098422	27108747764	TC00557-RI

All rights reserved.

This publication may not be reproduced in any form, in whole or in part, without a written approval from S-TEC Service Technologies GmbH & Co OG.  
Subject to change without notice!

# 4WD Systems References

## 2025



### Brand - Series

### Maingroup - Subgroup

### BMW - X3

### Gearbox, Powertrain - Transfer Case

OEM no	Successor no	Part number
27108465870		TC00555-RI
27108485037	27108465870; 27108686667	TC00555-RI
27108485602	27108465870; 27108686667	TC00555-RI
27108487143	27108465870; 27108686667	TC00555-RI
27108604770	27105A371E2; 27105A4A0C1	TC00401-RI
27108612554	27105A371E2; 27105A4A0C1	TC00401-RI
2710862144	27108465870; 27108686667	TC00555-RI
27108623348	27105A371E2; 27105A4A0C1	TC00401-RI
27108638719	27108465870; 27108686667	TC00555-RI
27108643151	27105A371E2; 27105A4A0C1	TC00401-RI
27108649053	27108465870; 27108686667	TC00555-RI
27108655148	27108465870; 27108686667	TC00555-RI
27108656295	27108465870; 27108686667	TC00555-RI
27108663655	27108465870; 27108686667	TC00555-RI
27108664091	27108465870; 27108686667	TC00555-RI
27108670280	27108465870; 27108686667	TC00555-RI
27108670282	27108465870; 27108686667	TC00555-RI
27108673168	27108465870; 27108686667	TC00555-RI
27108673712	27108465870; 27108686667	TC00555-RI
27108673713	27108465870; 27108686667	TC00555-RI
27108677684	27108465870; 27108686667	TC00555-RI
27108677687	27108465870; 27108686667	TC00555-RI
27108678470	27108465870; 27108686667	TC00555-RI
27108678472	27108465870; 27108686667	TC00555-RI
27108684857	27108465870; 27108686667	TC00555-RI
27108684859	27108465870; 27108686667	TC00555-RI
27108686667		TC00555-RI
27108687370	27108465870; 27108686667	TC00555-RI
27108697255	27105A371E2; 27105A4A0C1	TC00401-RI
27108697722	27108465870; 27108686667	TC00555-RI
27108697974	27105A371D9	TC00399-RI
27108740625	27108465870; 27108686667	TC00555-RI
27108747764		TC00557-RI
27109469019	27108465870; 27108686667	TC00555-RI
27109470187	27108465870; 27108686667	TC00555-RI
27109895299	27108465870; 27108686667	TC00555-RI

### BMW - X4

### Gearbox, Powertrain - Transfer Case

OEM no	Successor no	Part number
27102385073	27108465870; 27108686667	TC00555-RI
27105A371E2		TC00401-RI
27105A4A0C1		TC00401-RI

All rights reserved.

This publication may not be reproduced in any form, in whole or in part, without a written approval from S-TEC Service Technologies GmbH & Co OG.  
Subject to change without notice!

# 4WD Systems References

## 2025

**Brand - Series**

**Maingroup - Subgroup**

**BMW - X4**

**Gearbox, Powertrain - Transfer Case**

OEM no	Successor no	Part number
27107505376	27105A371E2; 27105A4A0C1	TC00401-RI
27107619646	27105A371E2; 27105A4A0C1	TC00401-RI
27107629179	27105A371E2; 27105A4A0C1	TC00401-RI
27107636180	27105A371E2; 27105A4A0C1	TC00401-RI
27107636489	27105A371E2; 27105A4A0C1	TC00401-RI
27107639265	27105A371E2; 27105A4A0C1	TC00401-RI
27107643760	27105A371E2; 27105A4A0C1	TC00401-RI
27107649784	27105A371E2; 27105A4A0C1	TC00401-RI
27107889033	27108465870; 27108686667	TC00555-RI
27108089528	27108747764	TC00557-RI
27108092621	27108747764	TC00557-RI
27108098422	27108747764	TC00557-RI
27108465870		TC00555-RI
27108485037	27108465870; 27108686667	TC00555-RI
27108485602	27108465870; 27108686667	TC00555-RI
27108487143	27108465870; 27108686667	TC00555-RI
27108604770	27105A371E2; 27105A4A0C1	TC00401-RI
27108612554	27105A371E2; 27105A4A0C1	TC00401-RI
2710862144	27108465870; 27108686667	TC00555-RI
27108623348	27105A371E2; 27105A4A0C1	TC00401-RI
27108638719	27108465870; 27108686667	TC00555-RI
27108643151	27105A371E2; 27105A4A0C1	TC00401-RI
27108649053	27108465870; 27108686667	TC00555-RI
27108655148	27108465870; 27108686667	TC00555-RI
27108656295	27108465870; 27108686667	TC00555-RI
27108663655	27108465870; 27108686667	TC00555-RI
27108664091	27108465870; 27108686667	TC00555-RI
27108670280	27108465870; 27108686667	TC00555-RI
27108670282	27108465870; 27108686667	TC00555-RI
27108673168	27108465870; 27108686667	TC00555-RI
27108673712	27108465870; 27108686667	TC00555-RI
27108673713	27108465870; 27108686667	TC00555-RI
27108677684	27108465870; 27108686667	TC00555-RI
27108677687	27108465870; 27108686667	TC00555-RI
27108678470	27108465870; 27108686667	TC00555-RI
27108678472	27108465870; 27108686667	TC00555-RI
27108684857	27108465870; 27108686667	TC00555-RI
27108684859	27108465870; 27108686667	TC00555-RI
27108686667		TC00555-RI
27108687370	27108465870; 27108686667	TC00555-RI
27108697255	27105A371E2; 27105A4A0C1	TC00401-RI
27108697722	27108465870; 27108686667	TC00555-RI
27108740625	27108465870; 27108686667	TC00555-RI
27108747764		TC00557-RI

All rights reserved.

This publication may not be reproduced in any form, in whole or in part, without a written approval from S-TEC Service Technologies GmbH & Co OG.  
Subject to change without notice!

### Brand - Series

### Maingroup - Subgroup

### BMW - X4

#### Gearbox, Powertrain - Transfer Case

OEM no	Successor no	Part number
27109469019	27108465870; 27108686667	TC00555-RI
27109470187	27108465870; 27108686667	TC00555-RI
27109895299	27108465870; 27108686667	TC00555-RI

### BMW - X5

#### Gearbox, Powertrain - Transfer Case

OEM no	Successor no	Part number
27102385073	27108465870; 27108686667	TC00555-RI
27102385074	27108465871; 27108686666	TC00556-RI
27105A371D7		TC00398-RI
27105A371D8		TC00400-RI
27105A371E0		TC00397-RI
27105A371E1		TC00396-RI
27105A371E2		TC00401-RI
27105A371E3		TC00403-RI
27105A371E4		TC00416-RI
27105A4A0B9		TC00397-RI
27105A4A0C0		TC00396-RI
27105A4A0C1		TC00401-RI
27105A4A0C2		TC00403-RI
27105A4A0C3		TC00416-RI
27107505376	27105A371E2; 27105A4A0C1	TC00401-RI
27107505377	27105A371E3; 27105A4A0C2	TC00403-RI
27107526279	27107555295; 27107555297	TC00039-RI
27107535869	27107555295; 27107555297	TC00039-RI
27107555295		TC00039-RI
27107555297		TC00039-RI
27107556249	27107599886; 27107599889	TC00200-RI
27107566252	27107599886; 27107599889	TC00200-RI
27107566253	27107599886; 27107599889	TC00200-RI
27107567644	27107599887; 27107599890	TC00261-RI
27107568233	27107599887; 27107599890	TC00261-RI
27107574777	27107599886; 27107599889	TC00200-RI
27107574778	27107599887; 27107599890	TC00261-RI
27107574825	27107599886; 27107599889	TC00200-RI
27107574826	27107599887; 27107599890	TC00261-RI
27107599886		TC00200-RI
27107599887		TC00261-RI
27107599889		TC00200-RI
27107599890		TC00261-RI
27107605344	27105A371D7	TC00398-RI
27107605345	27105A371D8	TC00400-RI
27107609196	27105A371D7	TC00398-RI

All rights reserved.

This publication may not be reproduced in any form, in whole or in part, without a written approval from S-TEC Service Technologies GmbH & Co OG.  
Subject to change without notice!



# 4WD Systems References

## 2025

### Brand - Series

### Maingroup - Subgroup

### BMW - X5

### Gearbox, Powertrain - Transfer Case

OEM no	Successor no	Part number
27107609197	27105A371D8	TC00400-RI
27107610586	27105A371D7	TC00398-RI
27107610587	27105A371D8	TC00400-RI
27107619178	27105A371D7	TC00398-RI
27107619179	27105A371D8	TC00400-RI
27107619644	27105A371E1; 27105A4A0C0	TC00396-RI
27107619645	27105A371E0; 27105A4A0B9	TC00397-RI
27107619646	27105A371E2; 27105A4A0C1	TC00401-RI
27107627944	27105A371D7	TC00398-RI
27107627945	27105A371D8	TC00400-RI
27107629177	27105A371E1; 27105A4A0C0	TC00396-RI
27107629178	27105A371E0; 27105A4A0B9	TC00397-RI
27107629179	27105A371E2; 27105A4A0C1	TC00401-RI
27107629405	27105A371D7	TC00398-RI
27107629406	27105A371D8	TC00400-RI
27107629605	27105A371D7	TC00398-RI
27107629606	27105A371D8	TC00400-RI
27107635753	27105A371D7	TC00398-RI
27107635754	27105A371D8	TC00400-RI
27107636180	27105A371E2; 27105A4A0C1	TC00401-RI
27107636444	27105A371E1; 27105A4A0C0	TC00396-RI
27107636445	27105A371E0; 27105A4A0B9	TC00397-RI
27107636480	27105A371D7	TC00398-RI
27107636481	27105A371D8	TC00400-RI
27107636487	27105A371E1; 27105A4A0C0	TC00396-RI
27107636488	27105A371E0; 27105A4A0B9	TC00397-RI
27107636489	27105A371E2; 27105A4A0C1	TC00401-RI
27107639265	27105A371E2; 27105A4A0C1	TC00401-RI
27107639271	27105A371D7	TC00398-RI
27107639272	27105A371D8	TC00400-RI
27107639273	27105A371E1; 27105A4A0C0	TC00396-RI
27107639274	27105A371E0; 27105A4A0B9	TC00397-RI
27107643751	27105A371D7	TC00398-RI
27107643752	27105A371D8	TC00400-RI
27107643758	27105A371E1; 27105A4A0C0	TC00396-RI
27107643759	27105A371E0; 27105A4A0B9	TC00397-RI
27107643760	27105A371E2; 27105A4A0C1	TC00401-RI
27107649182	27105A371E1; 27105A4A0C0	TC00396-RI
27107649784	27105A371E2; 27105A4A0C1	TC00401-RI
27107852166	27105A371E4; 27105A4A0C3	TC00416-RI
27107854164	27105A371E4; 27105A4A0C3	TC00416-RI
27107889033	27108465870; 27108686667	TC00555-RI
27107889034	27108465871; 27108686666	TC00556-RI
27108465870		TC00555-RI

All rights reserved.

This publication may not be reproduced in any form, in whole or in part, without a written approval from S-TEC Service Technologies GmbH & Co OG.  
Subject to change without notice!

# 4WD Systems References

## 2025

**Brand - Series**

**Maingroup - Subgroup**

**BMW - X5**

**Gearbox, Powertrain - Transfer Case**

OEM no	Successor no	Part number
27108465871		TC00556-RI
27108485037	27108465870; 27108686667	TC00555-RI
	27108465871; 27108686666	TC00556-RI
27108485602	27108465870; 27108686667	TC00555-RI
27108486042	27108465871; 27108686666	TC00556-RI
27108487143	27108465870; 27108686667	TC00555-RI
27108487144	27108465871; 27108686666	TC00556-RI
27108604770	27105A371E2; 27105A4A0C1	TC00401-RI
27108604771	27105A371E3; 27105A4A0C2	TC00403-RI
27108612554	27105A371E2; 27105A4A0C1	TC00401-RI
27108612555	27105A371E3; 27105A4A0C2	TC00403-RI
2710862144	27108465870; 27108686667	TC00555-RI
27108623348	27105A371E2; 27105A4A0C1	TC00401-RI
27108623349	27105A371E3; 27105A4A0C2	TC00403-RI
27108638719	27108465870; 27108686667	TC00555-RI
27108638720	27108465871; 27108686666	TC00556-RI
27108643151	27105A371E2; 27105A4A0C1	TC00401-RI
27108643152	27105A371E3; 27105A4A0C2	TC00403-RI
27108649053	27108465870; 27108686667	TC00555-RI
27108649060	27108465871; 27108686666	TC00556-RI
27108652145	27108465871; 27108686666	TC00556-RI
27108655148	27108465870; 27108686667	TC00555-RI
27108655149	27108465871; 27108686666	TC00556-RI
27108656295	27108465870; 27108686667	TC00555-RI
27108656296	27108465871; 27108686666	TC00556-RI
27108663654	27108465871; 27108686666	TC00556-RI
27108663655	27108465870; 27108686667	TC00555-RI
27108664091	27108465870; 27108686667	TC00555-RI
27108670280	27108465870; 27108686667	TC00555-RI
27108670281	27108465871; 27108686666	TC00556-RI
27108670282	27108465870; 27108686667	TC00555-RI
27108670283	27108465871; 27108686666	TC00556-RI
27108673168	27108465870; 27108686667	TC00555-RI
27108673711	27108465871; 27108686666	TC00556-RI
27108673712	27108465870; 27108686667	TC00555-RI
27108673713	27108465870; 27108686667	TC00555-RI
27108673714	27108465871; 27108686666	TC00556-RI
27108677684	27108465870; 27108686667	TC00555-RI
27108677685	27108465871; 27108686666	TC00556-RI
27108677686	27108465871; 27108686666	TC00556-RI
27108677687	27108465870; 27108686667	TC00555-RI
27108678470	27108465870; 27108686667	TC00555-RI
27108678471	27108465871; 27108686666	TC00556-RI
27108678472	27108465870; 27108686667	TC00555-RI

All rights reserved.

This publication may not be reproduced in any form, in whole or in part, without a written approval from S-TEC Service Technologies GmbH & Co OG.  
Subject to change without notice!

### Brand - Series

### Maingroup - Subgroup

### BMW - X5

#### Gearbox, Powertrain - Transfer Case

OEM no	Successor no	Part number
27108678473	27108465871; 27108686666	TC00556-RI
27108680317	27108465871; 27108686666	TC00556-RI
27108680318	27108465871; 27108686666	TC00556-RI
27108684857	27108465870; 27108686667	TC00555-RI
27108684858	27108465871; 27108686666	TC00556-RI
27108684859	27108465870; 27108686667	TC00555-RI
27108684860	27108465871; 27108686666	TC00556-RI
27108686666		TC00556-RI
27108686667		TC00555-RI
27108687370	27108465870; 27108686667	TC00555-RI
27108689416	27108465871; 27108686666	TC00556-RI
27108697255	27105A371E2; 27105A4A0C1	TC00401-RI
27108697256	27105A371E3; 27105A4A0C2	TC00403-RI
27108697257	27105A371E0; 27105A4A0B9	TC00397-RI
27108697721	27108465871; 27108686666	TC00556-RI
27108697722	27108465870; 27108686667	TC00555-RI
27108697723	27108465871; 27108686666	TC00556-RI
27108697972	27105A371D7	TC00398-RI
27108697973	27105A371D8	TC00400-RI
27108740625	27108465870; 27108686667	TC00555-RI
27108740626	27108465871; 27108686666	TC00556-RI
27109469019	27108465870; 27108686667	TC00555-RI
27109469020	27108465871; 27108686666	TC00556-RI
27109470187	27108465870; 27108686667	TC00555-RI
27109470188	27108465871; 27108686666	TC00556-RI
27109895299	27108465870; 27108686667	TC00555-RI
27109895300	27108465871; 27108686666	TC00556-RI

### BMW - X6

#### Gearbox, Powertrain - Transfer Case

OEM no	Successor no	Part number
27102385073	27108465870; 27108686667	TC00555-RI
27102385074	27108465871; 27108686666	TC00556-RI
27105A371D7		TC00398-RI
27105A371D8		TC00400-RI
27105A371E0		TC00397-RI
27105A371E1		TC00396-RI
27105A371E2		TC00401-RI
27105A371E3		TC00403-RI
27105A371E4		TC00416-RI
27105A4A0B9		TC00397-RI
27105A4A0C0		TC00396-RI
27105A4A0C1		TC00401-RI

All rights reserved.

This publication may not be reproduced in any form, in whole or in part, without a written approval from S-TEC Service Technologies GmbH & Co OG.  
Subject to change without notice!

# 4WD Systems References

## 2025

### Brand - Series

### Maingroup - Subgroup

### BMW - X6

### Gearbox, Powertrain - Transfer Case

OEM no	Successor no	Part number
27105A4A0C2		TC00403-RI
27105A4A0C3		TC00416-RI
27107505376	27105A371E2; 27105A4A0C1	TC00401-RI
27107505377	27105A371E3; 27105A4A0C2	TC00403-RI
27107556249	27107599886; 27107599889	TC00200-RI
27107556252	27107599886; 27107599889	TC00200-RI
27107556253	27107599886; 27107599889	TC00200-RI
27107567644	27107599887; 27107599890	TC00261-RI
27107568233	27107599887; 27107599890	TC00261-RI
27107574777	27107599886; 27107599889	TC00200-RI
27107574778	27107599887; 27107599890	TC00261-RI
27107574825	27107599886; 27107599889	TC00200-RI
27107574826	27107599887; 27107599890	TC00261-RI
27107590868	27107599898; 27107599899	TC00260-RI
27107599886		TC00200-RI
27107599887		TC00261-RI
27107599889		TC00200-RI
27107599890		TC00261-RI
27107599898		TC00260-RI
27107599899		TC00260-RI
27107605344	27105A371D7	TC00398-RI
27107605345	27105A371D8	TC00400-RI
27107609196	27105A371D7	TC00398-RI
27107609197	27105A371D8	TC00400-RI
27107610586	27105A371D7	TC00398-RI
27107610587	27105A371D8	TC00400-RI
27107619178	27105A371D7	TC00398-RI
27107619179	27105A371D8	TC00400-RI
27107619644	27105A371E1; 27105A4A0C0	TC00396-RI
27107619645	27105A371E0; 27105A4A0B9	TC00397-RI
27107619646	27105A371E2; 27105A4A0C1	TC00401-RI
27107627944	27105A371D7	TC00398-RI
27107627945	27105A371D8	TC00400-RI
27107629177	27105A371E1; 27105A4A0C0	TC00396-RI
27107629178	27105A371E0; 27105A4A0B9	TC00397-RI
27107629179	27105A371E2; 27105A4A0C1	TC00401-RI
27107629405	27105A371D7	TC00398-RI
27107629406	27105A371D8	TC00400-RI
27107629605	27105A371D7	TC00398-RI
27107629606	27105A371D8	TC00400-RI
27107635753	27105A371D7	TC00398-RI
27107635754	27105A371D8	TC00400-RI
27107636180	27105A371E2; 27105A4A0C1	TC00401-RI
27107636444	27105A371E1; 27105A4A0C0	TC00396-RI

All rights reserved.

This publication may not be reproduced in any form, in whole or in part, without a written approval from S-TEC Service Technologies GmbH & Co OG.  
Subject to change without notice!

**Brand - Series**

**Maingroup - Subgroup**

**BMW - X6**

**Gearbox, Powertrain - Transfer Case**

OEM no	Successor no	Part number
27107636445	27105A371E0; 27105A4A0B9	TC00397-RI
27107636480	27105A371D7	TC00398-RI
27107636481	27105A371D8	TC00400-RI
27107636487	27105A371E1; 27105A4A0C0	TC00396-RI
27107636488	27105A371E0; 27105A4A0B9	TC00397-RI
27107636489	27105A371E2; 27105A4A0C1	TC00401-RI
27107639265	27105A371E2; 27105A4A0C1	TC00401-RI
27107639271	27105A371D7	TC00398-RI
27107639272	27105A371D8	TC00400-RI
27107639273	27105A371E1; 27105A4A0C0	TC00396-RI
27107639274	27105A371E0; 27105A4A0B9	TC00397-RI
27107643751	27105A371D7	TC00398-RI
27107643752	27105A371D8	TC00400-RI
27107643758	27105A371E1; 27105A4A0C0	TC00396-RI
27107643759	27105A371E0; 27105A4A0B9	TC00397-RI
27107643760	27105A371E2; 27105A4A0C1	TC00401-RI
27107649182	27105A371E1; 27105A4A0C0	TC00396-RI
27107649784	27105A371E2; 27105A4A0C1	TC00401-RI
27107852166	27105A371E4; 27105A4A0C3	TC00416-RI
27107854164	27105A371E4; 27105A4A0C3	TC00416-RI
27107889033	27108465870; 27108686667	TC00555-RI
27107889034	27108465871; 27108686666	TC00556-RI
27108465870		TC00555-RI
27108465871		TC00556-RI
27108485037	27108465870; 27108686667	TC00555-RI
	27108465871; 27108686666	TC00556-RI
27108485602	27108465870; 27108686667	TC00555-RI
27108486042	27108465871; 27108686666	TC00556-RI
27108487143	27108465870; 27108686667	TC00555-RI
27108487144	27108465871; 27108686666	TC00556-RI
27108604770	27105A371E2; 27105A4A0C1	TC00401-RI
27108604771	27105A371E3; 27105A4A0C2	TC00403-RI
27108612554	27105A371E2; 27105A4A0C1	TC00401-RI
27108612555	27105A371E3; 27105A4A0C2	TC00403-RI
2710862144	27108465870; 27108686667	TC00555-RI
27108623348	27105A371E2; 27105A4A0C1	TC00401-RI
27108623349	27105A371E3; 27105A4A0C2	TC00403-RI
27108638719	27108465870; 27108686667	TC00555-RI
27108638720	27108465871; 27108686666	TC00556-RI
27108643151	27105A371E2; 27105A4A0C1	TC00401-RI
27108643152	27105A371E3; 27105A4A0C2	TC00403-RI
27108649053	27108465870; 27108686667	TC00555-RI
27108649060	27108465871; 27108686666	TC00556-RI
27108652145	27108465871; 27108686666	TC00556-RI

All rights reserved.

This publication may not be reproduced in any form, in whole or in part, without a written approval from S-TEC Service Technologies GmbH & Co OG.  
Subject to change without notice!

# 4WD Systems References

## 2025



### Brand - Series

### Maingroup - Subgroup

### BMW - X6

### Gearbox, Powertrain - Transfer Case

OEM no	Successor no	Part number
27108655148	27108465870; 27108686667	TC00555-RI
27108655149	27108465871; 27108686666	TC00556-RI
27108656295	27108465870; 27108686667	TC00555-RI
27108656296	27108465871; 27108686666	TC00556-RI
27108663654	27108465871; 27108686666	TC00556-RI
27108663655	27108465870; 27108686667	TC00555-RI
27108664091	27108465870; 27108686667	TC00555-RI
27108670280	27108465870; 27108686667	TC00555-RI
27108670281	27108465871; 27108686666	TC00556-RI
27108670282	27108465870; 27108686667	TC00555-RI
27108670283	27108465871; 27108686666	TC00556-RI
27108673168	27108465870; 27108686667	TC00555-RI
27108673711	27108465871; 27108686666	TC00556-RI
27108673712	27108465870; 27108686667	TC00555-RI
27108673713	27108465870; 27108686667	TC00555-RI
27108673714	27108465871; 27108686666	TC00556-RI
27108677684	27108465870; 27108686667	TC00555-RI
27108677685	27108465871; 27108686666	TC00556-RI
27108677686	27108465871; 27108686666	TC00556-RI
27108677687	27108465870; 27108686667	TC00555-RI
27108678470	27108465870; 27108686667	TC00555-RI
27108678471	27108465871; 27108686666	TC00556-RI
27108678472	27108465870; 27108686667	TC00555-RI
27108678473	27108465871; 27108686666	TC00556-RI
27108680317	27108465871; 27108686666	TC00556-RI
27108680318	27108465871; 27108686666	TC00556-RI
27108684857	27108465870; 27108686667	TC00555-RI
27108684858	27108465871; 27108686666	TC00556-RI
27108684859	27108465870; 27108686667	TC00555-RI
27108684860	27108465871; 27108686666	TC00556-RI
27108686666		TC00556-RI
27108686667		TC00555-RI
27108687370	27108465870; 27108686667	TC00555-RI
27108689416	27108465871; 27108686666	TC00556-RI
27108697255	27105A371E2; 27105A4A0C1	TC00401-RI
27108697256	27105A371E3; 27105A4A0C2	TC00403-RI
27108697257	27105A371E0; 27105A4A0B9	TC00397-RI
27108697721	27108465871; 27108686666	TC00556-RI
27108697722	27108465870; 27108686667	TC00555-RI
27108697723	27108465871; 27108686666	TC00556-RI
27108697972	27105A371D7	TC00398-RI
27108697973	27105A371D8	TC00400-RI
27108740625	27108465870; 27108686667	TC00555-RI
27108740626	27108465871; 27108686666	TC00556-RI

All rights reserved.

This publication may not be reproduced in any form, in whole or in part, without a written approval from S-TEC Service Technologies GmbH & Co OG.  
Subject to change without notice!

# 4WD Systems References

## 2025

**Brand - Series**

**Maingroup - Subgroup**

### BMW - X6

#### Gearbox, Powertrain - Transfer Case

OEM no	Successor no	Part number
27109469019	27108465870; 27108686667	TC00555-RI
27109469020	27108465871; 27108686666	TC00556-RI
27109470187	27108465870; 27108686667	TC00555-RI
27109470188	27108465871; 27108686666	TC00556-RI
27109895299	27108465870; 27108686667	TC00555-RI
27109895300	27108465871; 27108686666	TC00556-RI

### BMW - X7

#### Gearbox, Powertrain - Transfer Case

OEM no	Successor no	Part number
27102385073	27108465870; 27108686667	TC00555-RI
27102385074	27108465871; 27108686666	TC00556-RI
27107889033	27108465870; 27108686667	TC00555-RI
27107889034	27108465871; 27108686666	TC00556-RI
27108465870		TC00555-RI
27108465871		TC00556-RI
27108485037	27108465870; 27108686667	TC00555-RI
	27108465871; 27108686666	TC00556-RI
27108485602	27108465870; 27108686667	TC00555-RI
27108486042	27108465871; 27108686666	TC00556-RI
27108487143	27108465870; 27108686667	TC00555-RI
27108487144	27108465871; 27108686666	TC00556-RI
2710862144	27108465870; 27108686667	TC00555-RI
27108638719	27108465870; 27108686667	TC00555-RI
27108638720	27108465871; 27108686666	TC00556-RI
27108649053	27108465870; 27108686667	TC00555-RI
27108649060	27108465871; 27108686666	TC00556-RI
27108652145	27108465871; 27108686666	TC00556-RI
27108655148	27108465870; 27108686667	TC00555-RI
27108655149	27108465871; 27108686666	TC00556-RI
27108656295	27108465870; 27108686667	TC00555-RI
27108656296	27108465871; 27108686666	TC00556-RI
27108663654	27108465871; 27108686666	TC00556-RI
27108663655	27108465870; 27108686667	TC00555-RI
27108664091	27108465870; 27108686667	TC00555-RI
27108670280	27108465870; 27108686667	TC00555-RI
27108670281	27108465871; 27108686666	TC00556-RI
27108670282	27108465870; 27108686667	TC00555-RI
27108670283	27108465871; 27108686666	TC00556-RI
27108673168	27108465870; 27108686667	TC00555-RI
27108673711	27108465871; 27108686666	TC00556-RI
27108673712	27108465870; 27108686667	TC00555-RI
27108673713	27108465870; 27108686667	TC00555-RI

All rights reserved.

This publication may not be reproduced in any form, in whole or in part, without a written approval from S-TEC Service Technologies GmbH & Co OG.  
Subject to change without notice!

**Brand - Series**

**Maingroup - Subgroup**

**BMW - X7**

**Gearbox, Powertrain - Transfer Case**

OEM no	Successor no	Part number
27108673714	27108465871; 27108686666	TC00556-RI
27108677684	27108465870; 27108686667	TC00555-RI
27108677685	27108465871; 27108686666	TC00556-RI
27108677686	27108465871; 27108686666	TC00556-RI
27108677687	27108465870; 27108686667	TC00555-RI
27108678470	27108465870; 27108686667	TC00555-RI
27108678471	27108465871; 27108686666	TC00556-RI
27108678472	27108465870; 27108686667	TC00555-RI
27108678473	27108465871; 27108686666	TC00556-RI
27108680317	27108465871; 27108686666	TC00556-RI
27108680318	27108465871; 27108686666	TC00556-RI
27108684857	27108465870; 27108686667	TC00555-RI
27108684858	27108465871; 27108686666	TC00556-RI
27108684859	27108465870; 27108686667	TC00555-RI
27108684860	27108465871; 27108686666	TC00556-RI
27108686666		TC00556-RI
27108686667		TC00555-RI
27108687370	27108465870; 27108686667	TC00555-RI
27108689416	27108465871; 27108686666	TC00556-RI
27108697721	27108465871; 27108686666	TC00556-RI
27108697722	27108465870; 27108686667	TC00555-RI
27108697723	27108465871; 27108686666	TC00556-RI
27108740625	27108465870; 27108686667	TC00555-RI
27108740626	27108465871; 27108686666	TC00556-RI
27109469019	27108465870; 27108686667	TC00555-RI
27109469020	27108465871; 27108686666	TC00556-RI
27109470187	27108465870; 27108686667	TC00555-RI
27109470188	27108465871; 27108686666	TC00556-RI
27109895299	27108465870; 27108686667	TC00555-RI
27109895300	27108465871; 27108686666	TC00556-RI

All rights reserved.

This publication may not be reproduced in any form, in whole or in part, without a written approval from S-TEC Service Technologies GmbH & Co OG.  
Subject to change without notice!



# 4WD Systems References

## 2025



### Brand - Series

### Maingroup - Subgroup

### Chrysler - 300

#### Front Axle, Steering Unit - Power take off (PTO)

OEM no	Successor no	Part number
04591954AB		FD00045-RI
04591954AD	68495080AA	FD00061-RI
04591954AE	68495080AA	FD00061-RI
04591954AF	68495080AA	FD00061-RI
68437644AA	68495080AA	FD00061-RI
68495080AA		FD00061-RI

#### Gearbox, Powertrain - Transfer Case

OEM no	Successor no	Part number
04591953AC	04591953AI	TC00008-RI
04591953AE	04591953AI	TC00008-RI
04591953AF	04591953AI	TC00008-RI
04591953AG	04591953AI	TC00008-RI
04591953AH	04591953AI	TC00008-RI
04591953AI		TC00008-RI
68001953AI	04591953AI	TC00008-RI
RL001953AI	04591953AI	TC00008-RI

All rights reserved.

This publication may not be reproduced in any form, in whole or in part, without a written approval from S-TEC Service Technologies GmbH & Co OG.  
Subject to change without notice!

### Brand - Series

### Maingroup - Subgroup

### Dodge - Charger

#### Front Axle, Steering Unit - Power take off (PTO)

OEM no	Successor no	Part number
04591954AB		FD00045-RI
04591954AD	68495080AA	FD00061-RI
04591954AE	68495080AA	FD00061-RI
04591954AF	68495080AA	FD00061-RI
68437644AA	68495080AA	FD00061-RI
68495080AA		FD00061-RI

#### Gearbox, Powertrain - Transfer Case

OEM no	Successor no	Part number
04591953AC	04591953AI	TC00008-RI
04591953AE	04591953AI	TC00008-RI
04591953AF	04591953AI	TC00008-RI
04591953AG	04591953AI	TC00008-RI
04591953AH	04591953AI	TC00008-RI
04591953AI		TC00008-RI
68001953AI	04591953AI	TC00008-RI
RL001953AI	04591953AI	TC00008-RI

### Dodge - Magnum

#### Front Axle, Steering Unit - Power take off (PTO)

OEM no	Successor no	Part number
04591954AB		FD00045-RI

#### Gearbox, Powertrain - Transfer Case

OEM no	Successor no	Part number
04591953AC	04591953AI	TC00008-RI
04591953AE	04591953AI	TC00008-RI
04591953AF	04591953AI	TC00008-RI
04591953AG	04591953AI	TC00008-RI
04591953AH	04591953AI	TC00008-RI
04591953AI		TC00008-RI
68001953AI	04591953AI	TC00008-RI
RL001953AI	04591953AI	TC00008-RI

All rights reserved.

This publication may not be reproduced in any form, in whole or in part, without a written approval from S-TEC Service Technologies GmbH & Co OG.  
Subject to change without notice!

# 4WD Systems References

## 2025



**Brand - Series**

**Maingroup - Subgroup**

**Fiat - Panda**

**Rear Axle - Rear Differential**

OEM no	Successor no	Part number
55236586	55263470	RD00095-RI
55263458	55263470	RD00095-RI
55263470		RD00095-RI

All rights reserved.

This publication may not be reproduced in any form, in whole or in part, without a written approval from S-TEC Service Technologies GmbH & Co OG.  
Subject to change without notice!

# 4WD Systems References

2025



**Brand - Series**

**Maingroup - Subgroup**

**Hyundai - Genesis**

**Gearbox, Powertrain - Transfer Case**

OEM no	Successor no	Part number
473004E000		TC00512-RI

All rights reserved.

This publication may not be reproduced in any form, in whole or in part, without a written approval from S-TEC Service Technologies GmbH & Co OG.  
Subject to change without notice!

**Brand - Series****Maingroup - Subgroup****Infiniti - QX56****Gearbox, Powertrain - Transfer Case**

OEM no	Successor no	Part number
331001LA0A	331001LA0E	TC00271-RI
331001LA0D	331001LA0E	TC00271-RI
331001LA0E		TC00271-RI

**Infiniti - QX80****Gearbox, Powertrain - Transfer Case**

OEM no	Successor no	Part number
331001LA0A	331001LA0E	TC00271-RI
331001LA0D	331001LA0E	TC00271-RI
331001LA0E		TC00271-RI

All rights reserved.

This publication may not be reproduced in any form, in whole or in part, without a written approval from S-TEC Service Technologies GmbH & Co OG.  
Subject to change without notice!

### Brand - Series

### Maingroup - Subgroup

### Jaguar - F-Type

#### Gearbox, Powertrain - Transfer Case

OEM no	Successor no	Part number
02C2D49257	FW937K780AF	TC00511-RI
02T2H1340	FW937K780AF	TC00511-RI
FW937K780AA	FW937K780AF	TC00511-RI
FW937K780AB	FW937K780AF	TC00511-RI
FW937K780AC	FW937K780AF	TC00511-RI
FW937K780AD	FW937K780AF	TC00511-RI
FW937K780AE	FW937K780AF	TC00511-RI
FW937K780AF		TC00511-RI

### Jaguar - XJ

#### Gearbox, Powertrain - Transfer Case

OEM no	Successor no	Part number
02C2D49257	FW937K780AF	TC00511-RI
02T2H1340	FW937K780AF	TC00511-RI
FW937K780AA	FW937K780AF	TC00511-RI
FW937K780AB	FW937K780AF	TC00511-RI
FW937K780AC	FW937K780AF	TC00511-RI
FW937K780AD	FW937K780AF	TC00511-RI
FW937K780AE	FW937K780AF	TC00511-RI
FW937K780AF		TC00511-RI

All rights reserved.

This publication may not be reproduced in any form, in whole or in part, without a written approval from S-TEC Service Technologies GmbH & Co OG.  
Subject to change without notice!

### Brand - Series

### Maingroup - Subgroup

### Land Rover - Discovery

### Gearbox, Powertrain - Transfer Case

OEM no	Successor no	Part number
CPLA7K780AA	LR006016; LR008206; LR049160	TC00404-RI
CPLA7K780AB	LR006016; LR008206; LR049160	TC00404-RI
CPLA7K780AC	LR006016; LR008206; LR049160	TC00404-RI
CPLA7K780BA	LR089531	TC00487-RI
CPLA7K780BB	LR089531	TC00487-RI
DPLA7K780AB	LR089529	TC00488-RI
DPLA7K780AC	LR089529	TC00488-RI
DPLA7K780AD	LR089529	TC00488-RI
DPLA7K780AE	LR089529	TC00488-RI
DPLA7K780AF	LR089529	TC00488-RI
HPLA7K780BA	HPLA7K780BD; LR117096	TC00545-RI
HPLA7K780BB	HPLA7K780BD; LR117096	TC00545-RI
HPLA7K780BC	HPLA7K780BD; LR117096	TC00545-RI
HPLA7K780BD		TC00545-RI
IAB500240	LR006016; LR008206; LR049160	TC00404-RI
IAB500241	LR006016; LR008206; LR049160	TC00404-RI
IAB500243	LR006016; LR008206; LR049160	TC00404-RI
IAB500244	LR006016; LR008206; LR049160	TC00404-RI
IAB500280	LR006016; LR008206; LR049160	TC00404-RI
LR006016		TC00404-RI
LR008206		TC00404-RI
LR023011	LR006016; LR008206; LR049160	TC00404-RI
LR035617	LR006016; LR008206; LR049160	TC00404-RI
LR045365	LR089529	TC00488-RI
LR045477	LR006016; LR008206; LR049160	TC00404-RI
LR049160		TC00404-RI
LR050773	LR089529	TC00488-RI
LR052611	LR089531	TC00487-RI
LR078932	LR089529	TC00488-RI
LR082663	HPLA7K780BD; LR117096	TC00545-RI
LR089529		TC00488-RI
LR089531		TC00487-RI
LR105963	HPLA7K780BD; LR117096	TC00545-RI
LR117096		TC00545-RI

All rights reserved.

This publication may not be reproduced in any form, in whole or in part, without a written approval from S-TEC Service Technologies GmbH & Co OG.  
Subject to change without notice!

### Brand - Series

### Maingroup - Subgroup

### Land Rover - Freelander

#### Gearbox, Powertrain - Transfer Case

OEM no	Successor no	Part number
TAG000220		TC00006-RI

### Land Rover - Range Rover

#### Gearbox, Powertrain - Transfer Case

OEM no	Successor no	Part number
CPLA7K780AA	LR006016; LR008206; LR049160	TC00404-RI
CPLA7K780AB	LR006016; LR008206; LR049160	TC00404-RI
CPLA7K780AC	LR006016; LR008206; LR049160	TC00404-RI
CPLA7K780BA	LR089531	TC00487-RI
CPLA7K780BB	LR089531	TC00487-RI
DPLA7K780AB	LR089529	TC00488-RI
DPLA7K780AC	LR089529	TC00488-RI
DPLA7K780AD	LR089529	TC00488-RI
DPLA7K780AE	LR089529	TC00488-RI
DPLA7K780AF	LR089529	TC00488-RI
HPLA7K780BA	HPLA7K780BD; LR117096	TC00545-RI
HPLA7K780BB	HPLA7K780BD; LR117096	TC00545-RI
HPLA7K780BC	HPLA7K780BD; LR117096	TC00545-RI
HPLA7K780BD		TC00545-RI
IAB000031	IAB000033	TC00012-RI
IAB000033		TC00012-RI
IAB500240	LR006016; LR008206; LR049160	TC00404-RI
IAB500241	LR006016; LR008206; LR049160	TC00404-RI
IAB500243	LR006016; LR008206; LR049160	TC00404-RI
IAB500244	LR006016; LR008206; LR049160	TC00404-RI
IAB500280	LR006016; LR008206; LR049160	TC00404-RI
LR006016		TC00404-RI
LR008206		TC00404-RI
LR023011	LR006016; LR008206; LR049160	TC00404-RI
LR035617	LR006016; LR008206; LR049160	TC00404-RI
LR045365	LR089529	TC00488-RI
LR045477	LR006016; LR008206; LR049160	TC00404-RI
LR049160		TC00404-RI
LR050773	LR089529	TC00488-RI
LR052611	LR089531	TC00487-RI
LR078932	LR089529	TC00488-RI
LR082663	HPLA7K780BD; LR117096	TC00545-RI

All rights reserved.

This publication may not be reproduced in any form, in whole or in part, without a written approval from S-TEC Service Technologies GmbH & Co OG.  
Subject to change without notice!



# 4WD Systems References

2025



**Brand - Series**

**Maingroup - Subgroup**

**Land Rover - Range Rover**

**Gearbox, Powertrain - Transfer Case**

OEM no	Successor no	Part number
LR089529		TC00488-RI
LR089531		TC00487-RI
LR105963	HPLA7K780BD; LR117096	TC00545-RI
LR117096		TC00545-RI

All rights reserved.

This publication may not be reproduced in any form, in whole or in part, without a written approval from S-TEC Service Technologies GmbH & Co OG.  
Subject to change without notice!

### Brand - Series

### Maingroup - Subgroup

### Maserati - Ghibli

#### Gearbox, Powertrain - Transfer Case

OEM no	Successor no	Part number
670007315	673009767	TC00513-RI
670008138	673009767	TC00513-RI
670033011	673009767	TC00513-RI
670100396	670152725	TC00514-RI
670152725		TC00514-RI
673009767		TC00513-RI

### Maserati - Levante

#### Gearbox, Powertrain - Transfer Case

OEM no	Successor no	Part number
670033866	670152726	TC00528-RI
670035039	670152726	TC00528-RI
670038072	670152726	TC00528-RI
670152726		TC00528-RI

### Maserati - Quattroporte

#### Gearbox, Powertrain - Transfer Case

OEM no	Successor no	Part number
670007315	673009767	TC00513-RI
670008138	673009767	TC00513-RI
670033011	673009767	TC00513-RI
670100396	670152725	TC00514-RI
670152725		TC00514-RI
673009767		TC00513-RI

All rights reserved.

This publication may not be reproduced in any form, in whole or in part, without a written approval from S-TEC Service Technologies GmbH & Co OG.  
Subject to change without notice!

### Brand - Series

### Maingroup - Subgroup

### Mercedes-Benz - A-Class

#### Rear Axle - Rear Differential

OEM no	Successor no	Part number
A1763501300	A1763503100	RD00098-RI
A1763501900	A1763503100	RD00098-RI
A1763502000	A1763503100	RD00098-RI
A1763502500	A1763503100	RD00098-RI
A1763502800	A1763503100	RD00098-RI
A1763502900	A1763503100	RD00098-RI
A1763503000	A1763503100	RD00098-RI
A1763503100		RD00098-RI

### Mercedes-Benz - B-Class

#### Rear Axle - Rear Differential

OEM no	Successor no	Part number
A1763501300	A1763503100	RD00098-RI
A1763501900	A1763503100	RD00098-RI
A1763502000	A1763503100	RD00098-RI
A1763502500	A1763503100	RD00098-RI
A1763502800	A1763503100	RD00098-RI
A1763502900	A1763503100	RD00098-RI
A1763503000	A1763503100	RD00098-RI
A1763503100		RD00098-RI

### Mercedes-Benz - C-Class

#### Gearbox, Powertrain - Transfer Case

OEM no	Successor no	Part number
A2032800300	A2032800700	TC00210-RI
A2032800600	A2032800700	TC00210-RI
A2032800700		TC00210-RI

### Mercedes-Benz - CLA-Class

#### Rear Axle - Rear Differential

OEM no	Successor no	Part number
A1763501300	A1763503100	RD00098-RI
A1763501900	A1763503100	RD00098-RI
A1763502000	A1763503100	RD00098-RI
A1763502500	A1763503100	RD00098-RI
A1763502800	A1763503100	RD00098-RI
A1763502900	A1763503100	RD00098-RI
A1763503000	A1763503100	RD00098-RI
A1763503100		RD00098-RI

All rights reserved.

This publication may not be reproduced in any form, in whole or in part, without a written approval from S-TEC Service Technologies GmbH & Co OG.  
Subject to change without notice!

### Brand - Series

### Maingroup - Subgroup

### Mercedes-Benz - E-Class

#### Gearbox, Powertrain - Transfer Case

OEM no	Successor no	Part number
A2032800300	A2032800700	TC00210-RI
A2032800600	A2032800700	TC00210-RI
A2032800700		TC00210-RI
A2102800000	A2102800100	TC00014-RI
A2102800100		TC00014-RI
A2112800100	A2112801000	TC00187-RI
A2112800400	A2112801000	TC00187-RI
A2112800500	A2112801000	TC00187-RI
A2112800700	A2112800900	TC00203-RI
A2112800800	A2112801000	TC00187-RI
A2112800900		TC00203-RI
A2112801000		TC00187-RI
A2202800300	A2202800700	TC00185-RI
A2202800600	A2202800700	TC00185-RI
A2202800700		TC00185-RI

### Mercedes-Benz - G-Class

#### Gearbox, Powertrain - Transfer Case

OEM no	Successor no	Part number
750.650	A4632801100	TC00277-RI
750.651	A4632801000	TC00276-RI
750.652	A4632801400	TC00278-RI
750.653	A4632801500	TC00022-RI
750.654	A4632801700	TC00023-RI
A4602800700	A4602803600	TC00019-RI
A4602801200	A4602803600	TC00019-RI
A4602801500	A4602803600	TC00019-RI
A4602802100	A4602803600	TC00019-RI
A4602803600		TC00019-RI
A4612801200	A4602803600	TC00019-RI
A4612801500	A4602803600	TC00019-RI
A4632801000		TC00276-RI
A4632801100		TC00277-RI
A4632801400		TC00278-RI
A4632801500		TC00022-RI
A4632801700		TC00023-RI

### Mercedes-Benz - GL-Class

#### Gearbox, Powertrain - Transfer Case

OEM no	Successor no	Part number
A1642800800	A1662800800	TC00280-RI
A1642800900	A1642801200	TC00269-RI
A1642801000	A1662800800	TC00280-RI

All rights reserved.

This publication may not be reproduced in any form, in whole or in part, without a written approval from S-TEC Service Technologies GmbH & Co OG.  
Subject to change without notice!

### Brand - Series

### Maingroup - Subgroup

### Mercedes-Benz - GL-Class

#### Gearbox, Powertrain - Transfer Case

OEM no	Successor no	Part number
A1642801100	A1662800800	TC00280-RI
A1642801200		TC00269-RI
A1642801300	A1662800800	TC00280-RI
A1642801400	A1662800800	TC00280-RI
A1662800300	A1662800800	TC00280-RI
A1662800800		TC00280-RI
A2512800700	A2512802700; A2512803100; A2512803500	TC00274-RI
A2512800800	A2512801300	TC00268-RI
A2512800900	A2512802700; A2512803100; A2512803500	TC00274-RI
A2512801200	A2512802700; A2512803100; A2512803500	TC00274-RI
A2512801300		TC00268-RI
A2512801500	A2512802700; A2512803100; A2512803500	TC00274-RI
A2512801800	A2512802700; A2512803100; A2512803500	TC00274-RI
A2512802000	A2512802800	TC00537-RI
A2512802100	A2512802700; A2512803100; A2512803500	TC00274-RI
A2512802200	A2512803200	TC00527-RI
A2512802700		TC00274-RI
A2512802800		TC00537-RI
A2512803100		TC00274-RI
A2512803200		TC00527-RI
A2512803500		TC00274-RI

### Mercedes-Benz - GLA-Class

#### Rear Axle - Rear Differential

OEM no	Successor no	Part number
A1763501300	A1763503100	RD00098-RI
A1763501900	A1763503100	RD00098-RI
A1763502000	A1763503100	RD00098-RI
A1763502500	A1763503100	RD00098-RI
A1763502800	A1763503100	RD00098-RI
A1763502900	A1763503100	RD00098-RI
A1763503000	A1763503100	RD00098-RI
A1763503100		RD00098-RI

### Mercedes-Benz - GLE-Class

#### Gearbox, Powertrain - Transfer Case

OEM no	Successor no	Part number
A1642800800	A1662800800	TC00280-RI
A1642801000	A1662800800	TC00280-RI

All rights reserved.

This publication may not be reproduced in any form, in whole or in part, without a written approval from S-TEC Service Technologies GmbH & Co OG.  
Subject to change without notice!

### Brand - Series

### Maingroup - Subgroup

### Mercedes-Benz - GLE-Class

#### Gearbox, Powertrain - Transfer Case

OEM no	Successor no	Part number
A1642801100	A1662800800	TC00280-RI
A1642801300	A1662800800	TC00280-RI
A1642801400	A1662800800	TC00280-RI
A1662800300	A1662800800	TC00280-RI
A1662800800		TC00280-RI
A2512800700	A2512802700; A2512803100; A2512803500	TC00274-RI
A2512800900	A2512802700; A2512803100; A2512803500	TC00274-RI
A2512801200	A2512802700; A2512803100; A2512803500	TC00274-RI
A2512801500	A2512802700; A2512803100; A2512803500	TC00274-RI
A2512801800	A2512802700; A2512803100; A2512803500	TC00274-RI
A2512802000	A2512802800	TC00537-RI
A2512802100	A2512802700; A2512803100; A2512803500	TC00274-RI
A2512802200	A2512803200	TC00527-RI
A2512802700		TC00274-RI
A2512802800		TC00537-RI
A2512803100		TC00274-RI
A2512803200		TC00527-RI
A2512803500		TC00274-RI

### Mercedes-Benz - GLS-Class

#### Gearbox, Powertrain - Transfer Case

OEM no	Successor no	Part number
A1642800800	A1662800800	TC00280-RI
A1642801000	A1662800800	TC00280-RI
A1642801100	A1662800800	TC00280-RI
A1642801300	A1662800800	TC00280-RI
A1642801400	A1662800800	TC00280-RI
A1662800300	A1662800800	TC00280-RI
A1662800800		TC00280-RI
A2512800700	A2512802700; A2512803100; A2512803500	TC00274-RI
A2512800900	A2512802700; A2512803100; A2512803500	TC00274-RI
A2512801200	A2512802700; A2512803100; A2512803500	TC00274-RI
A2512801500	A2512802700; A2512803100; A2512803500	TC00274-RI
A2512801800	A2512802700; A2512803100; A2512803500	TC00274-RI
A2512802000	A2512802800	TC00537-RI
A2512802100	A2512802700; A2512803100; A2512803500	TC00274-RI

All rights reserved.

This publication may not be reproduced in any form, in whole or in part, without a written approval from S-TEC Service Technologies GmbH & Co OG.  
Subject to change without notice!

### Brand - Series

### Maingroup - Subgroup

### Mercedes-Benz - GLS-Class

#### Gearbox, Powertrain - Transfer Case

OEM no	Successor no	Part number
A2512802200	A2512803200	TC00527-RI
A2512802700		TC00274-RI
A2512802800		TC00537-RI
A2512803100		TC00274-RI
A2512803200		TC00527-RI
A2512803500		TC00274-RI

### Mercedes-Benz - M-Class

#### Gearbox, Powertrain - Transfer Case

OEM no	Successor no	Part number
A1642800800	A1662800800	TC00280-RI
A1642800900	A1642801200	TC00269-RI
A1642801000	A1662800800	TC00280-RI
A1642801100	A1662800800	TC00280-RI
A1642801200		TC00269-RI
A1642801300	A1662800800	TC00280-RI
A1642801400	A1662800800	TC00280-RI
A1662800300	A1662800800	TC00280-RI
A1662800800		TC00280-RI
A2512800700	A2512802700; A2512803100; A2512803500	TC00274-RI
A2512800800	A2512801300	TC00268-RI
A2512800900	A2512802700; A2512803100; A2512803500	TC00274-RI
A2512801100	A2512801400	TC00282-RI
A2512801200	A2512802700; A2512803100; A2512803500	TC00274-RI
A2512801300		TC00268-RI
A2512801400		TC00282-RI
A2512801500	A2512802700; A2512803100; A2512803500	TC00274-RI
A2512801700		TC00283-RI
A2512801800	A2512802700; A2512803100; A2512803500	TC00274-RI
A2512802000	A2512802800	TC00537-RI
A2512802100	A2512802700; A2512803100; A2512803500	TC00274-RI
A2512802200	A2512803200	TC00527-RI
A2512802700		TC00274-RI
A2512802800		TC00537-RI
A2512803100		TC00274-RI
A2512803200		TC00527-RI
A2512803500		TC00274-RI

All rights reserved.

This publication may not be reproduced in any form, in whole or in part, without a written approval from S-TEC Service Technologies GmbH & Co OG.  
Subject to change without notice!

### Brand - Series

### Maingroup - Subgroup

### Mercedes-Benz - R-Class

#### Gearbox, Powertrain - Transfer Case

OEM no	Successor no	Part number
A1642800900	A1642801200	TC00269-RI
A1642801200		TC00269-RI
A2512800700	A2512802700; A2512803100; A2512803500	TC00274-RI
A2512800900	A2512802700; A2512803100; A2512803500	TC00274-RI
A2512801100	A2512801400	TC00282-RI
A2512801200	A2512802700; A2512803100; A2512803500	TC00274-RI
A2512801400		TC00282-RI
A2512801500	A2512802700; A2512803100; A2512803500	TC00274-RI
A2512801800	A2512802700; A2512803100; A2512803500	TC00274-RI
A2512802100	A2512802700; A2512803100; A2512803500	TC00274-RI
A2512802700		TC00274-RI
A2512803100		TC00274-RI
A2512803500		TC00274-RI

### Mercedes-Benz - S-Class

#### Gearbox, Powertrain - Transfer Case

OEM no	Successor no	Part number
A2202800300	A2202800700	TC00185-RI
A2202800600	A2202800700	TC00185-RI
A2202800700		TC00185-RI

All rights reserved.

This publication may not be reproduced in any form, in whole or in part, without a written approval from S-TEC Service Technologies GmbH & Co OG.  
Subject to change without notice!



### Brand - Series

### Maingroup - Subgroup

### Nissan - Armada

#### Gearbox, Powertrain - Transfer Case

OEM no	Successor no	Part number
331001LA0A	331001LA0E	TC00271-RI
331001LA0D	331001LA0E	TC00271-RI
331001LA0E		TC00271-RI

### Nissan - Pathfinder

#### Gearbox, Powertrain - Transfer Case

OEM no	Successor no	Part number
331001LA0A	331001LA0E	TC00271-RI
331001LA0D	331001LA0E	TC00271-RI
331001LA0E		TC00271-RI

### Nissan - Patrol

#### Gearbox, Powertrain - Transfer Case

OEM no	Successor no	Part number
331001LA0A	331001LA0E	TC00271-RI
331001LA0D	331001LA0E	TC00271-RI
331001LA0E		TC00271-RI
331001LU0A	331001LU0C	TC00272-RI
331001LU0B	331001LU0C	TC00272-RI
331001LU0C		TC00272-RI

All rights reserved.

This publication may not be reproduced in any form, in whole or in part, without a written approval from S-TEC Service Technologies GmbH & Co OG.  
Subject to change without notice!

# 4WD Systems References

## 2025

### Brand - Series

### Maingroup - Subgroup

### Porsche - Cayenne

### Gearbox, Powertrain - Transfer Case

OEM no	Successor no	Part number
00004311011	0C2341042K; 958341042D; 958341042DX	TC00299-RI
00004311013	0C2341042M; 958341042F; 958341042FX	TC00301-RI
0AD341040Q	0AD341041M; 95534104055	TC00181-RI
0AD341040R	0AD341041N; 95534104005	TC00182-RI
0AD341041A	0AD341041N; 95534104005	TC00182-RI
0AD341041H	0AD341041M; 95534104055	TC00181-RI
0AD341041J	0AD341041N; 95534104005	TC00182-RI
0AD341041K	0AD341041Q; 95534104024	TC00183-RI
0AD341041M		TC00181-RI
0AD341041N		TC00182-RI
0AD341041Q		TC00183-RI
0BU341010B	0BU341011Q; 95834102003	TC00311-RI
0BU341010L	0BU341011T; 95834102021	TC00319-RI
0BU341010M	0BU341011M; 95834102012	TC00323-RI
0BU341010R	0BU341011Q; 95834102003	TC00311-RI
0BU341011B	0BU341011T; 95834102021	TC00319-RI
0BU341011C	0BU341011M; 95834102012	TC00323-RI
0BU341011D	0BU341011Q; 95834102003	TC00311-RI
0BU341011G	0BU341011Q; 95834102003	TC00311-RI
0BU341011J	0BU341011T; 95834102021	TC00319-RI
0BU341011K	0BU341011M; 95834102012	TC00323-RI
0BU341011M		TC00323-RI
0BU341011Q		TC00311-RI
0BU341011T		TC00319-RI
0C2341010M	0C2341042K; 958341042D; 958341042DX	TC00299-RI
0C2341010P	0C2341042M; 958341042F; 958341042FX	TC00301-RI
0C2341010Q	0C2341042K; 958341042D; 958341042DX	TC00299-RI
0C2341010R	0C2341042L; 958341042E; 958341042EX	TC00300-RI
0C2341010S	0C2341042M; 958341042F; 958341042FX	TC00301-RI
0C2341011A	0C2341042L; 958341042E; 958341042EX	TC00300-RI
0C2341011B	0C2341042M; 958341042F; 958341042FX	TC00301-RI
0C2341011C	0C2341042K; 958341042D; 958341042DX	TC00299-RI
0C2341011F	0C2341042K; 958341042D; 958341042DX	TC00299-RI
0C2341011G	0C2341042L; 958341042E; 958341042EX	TC00300-RI
0C2341011H	0C2341042M; 958341042F; 958341042FX	TC00301-RI
0C2341011K	0C2341042K; 958341042D; 958341042DX	TC00299-RI

All rights reserved.

This publication may not be reproduced in any form, in whole or in part, without a written approval from S-TEC Service Technologies GmbH & Co OG.  
Subject to change without notice!

### Brand - Series

### Maingroup - Subgroup

### Porsche - Cayenne

### Gearbox, Powertrain - Transfer Case

OEM no	Successor no	Part number
0C2341011L	0C2341042L; 958341042E; 958341042EX	TC00300-RI
0C2341011M	0C2341042M; 958341042F; 958341042FX	TC00301-RI
0C2341011N	0C2341042N; 958341042G; 958341042GX	TC00467-RI
0C2341011P	0C2341042N; 958341042G; 958341042GX	TC00467-RI
0C2341011Q	0C2341042K; 958341042D; 958341042DX	TC00299-RI
0C2341011R	0C2341042L; 958341042E; 958341042EX	TC00300-RI
0C2341011S	0C2341042M; 958341042F; 958341042FX	TC00301-RI
0C2341011T	0C2341042N; 958341042G; 958341042GX	TC00467-RI
0C2341011_	0C2341042K; 958341042D; 958341042DX	TC00299-RI
0C2341012F	0C2341042K; 958341042D; 958341042DX	TC00299-RI
0C2341012G	0C2341042L; 958341042E; 958341042EX	TC00300-RI
0C2341012H	0C2341042M; 958341042F; 958341042FX	TC00301-RI
0C2341012J	0C2341042N; 958341042G; 958341042GX	TC00467-RI
0C2341012K	0C2341042K; 958341042D; 958341042DX	TC00299-RI
0C2341012L	0C2341042L; 958341042E; 958341042EX	TC00300-RI
0C2341012M	0C2341042M; 958341042F; 958341042FX	TC00301-RI
0C2341012N	0C2341042N; 958341042G; 958341042GX	TC00467-RI
0C2341013	0C2341042F; 958341042; 958341042X	TC00505-RI
0C2341013A	0C2341042G; 958341042A; 958341042AX	TC00504-RI
0C2341013B	0C2341042H; 958341042B; 958341042BX	TC00507-RI
0C2341013C	0C2341042J; 958341042C; 958341042CX	TC00506-RI
0C2341013D	0C2341042F; 958341042; 958341042X	TC00505-RI
0C2341013E	0C2341042G; 958341042A; 958341042AX	TC00504-RI
0C2341013F	0C2341042H; 958341042B; 958341042BX	TC00507-RI
0C2341013G	0C2341042J; 958341042C; 958341042CX	TC00506-RI
0C2341013H	0C2341042F; 958341042; 958341042X	TC00505-RI
0C2341013J	0C2341042G; 958341042A; 958341042AX	TC00504-RI
0C2341013K	0C2341042H; 958341042B; 958341042BX	TC00507-RI

All rights reserved.

This publication may not be reproduced in any form, in whole or in part, without a written approval from S-TEC Service Technologies GmbH & Co OG.  
Subject to change without notice!

### Brand - Series

### Maingroup - Subgroup

### Porsche - Cayenne

### Gearbox, Powertrain - Transfer Case

OEM no	Successor no	Part number
0C2341013L	0C2341042J; 958341042C; 958341042CX	TC00506-RI
0C2341013M	0C2341042G; 958341042A; 958341042AX	TC00504-RI
0C2341013N	0C2341042J; 958341042C; 958341042CX	TC00506-RI
0C2341013P	0C2341042F; 958341042; 958341042X	TC00505-RI
0C2341013Q	0C2341042H; 958341042B; 958341042BX	TC00507-RI
0C2341013R	0C2341042F; 958341042; 958341042X	TC00505-RI
0C2341013S	0C2341042G; 958341042A; 958341042AX	TC00504-RI
0C2341013T	0C2341042H; 958341042B; 958341042BX	TC00507-RI
0C2341041	0C2341042J; 958341042C; 958341042CX	TC00506-RI
0C2341041A	0C2341042F; 958341042; 958341042X	TC00505-RI
0C2341041B	0C2341042G; 958341042A; 958341042AX	TC00504-RI
0C2341041C	0C2341042H; 958341042B; 958341042BX	TC00507-RI
0C2341041D	0C2341042J; 958341042C; 958341042CX	TC00506-RI
0C2341041J	0C2341042G; 958341042A; 958341042AX	TC00504-RI
0C2341041K	0C2341042F; 958341042; 958341042X	TC00505-RI
0C2341041L	0C2341042H; 958341042B; 958341042BX	TC00507-RI
0C2341041M	0C2341042J; 958341042C; 958341042CX	TC00506-RI
0C2341041S	0C2341042G; 958341042A; 958341042AX	TC00504-RI
0C2341041T	0C2341042F; 958341042; 958341042X	TC00505-RI
0C2341042	0C2341042H; 958341042B; 958341042BX	TC00507-RI
0C2341042A	0C2341042J; 958341042C; 958341042CX	TC00506-RI
0C2341042B	0C2341042K; 958341042D; 958341042DX	TC00299-RI
0C2341042C	0C2341042L; 958341042E; 958341042EX	TC00300-RI
0C2341042D	0C2341042M; 958341042F; 958341042FX	TC00301-RI
0C2341042E	0C2341042N; 958341042G; 958341042GX	TC00467-RI
0C2341042F		TC00505-RI
0C2341042G		TC00504-RI
0C2341042H		TC00507-RI
0C2341042J		TC00506-RI

All rights reserved.

This publication may not be reproduced in any form, in whole or in part, without a written approval from S-TEC Service Technologies GmbH & Co OG.  
Subject to change without notice!

# 4WD Systems References

## 2025

### Brand - Series

### Maingroup - Subgroup

### Porsche - Cayenne

### Gearbox, Powertrain - Transfer Case

OEM no	Successor no	Part number
0C2341042K		TC00299-RI
0C2341042L		TC00300-RI
0C2341042M		TC00301-RI
0C2341042N		TC00467-RI
95534104001	0AD341041N; 95534104005	TC00182-RI
95534104002	0AD341041N; 95534104005	TC00182-RI
95534104003	0AD341041N; 95534104005	TC00182-RI
95534104004	0AD341041N; 95534104005	TC00182-RI
95534104005		TC00182-RI
95534104020	0AD341041Q; 95534104024	TC00183-RI
95534104021	0AD341041Q; 95534104024	TC00183-RI
95534104022	0AD341041Q; 95534104024	TC00183-RI
95534104023	0AD341041Q; 95534104024	TC00183-RI
95534104024		TC00183-RI
95534104051	0AD341041M; 95534104055	TC00181-RI
95534104052	0AD341041M; 95534104055	TC00181-RI
95534104053	0AD341041M; 95534104055	TC00181-RI
95534104054	0AD341041M; 95534104055	TC00181-RI
95534104055		TC00181-RI
9553410408X	0AD341041Q; 95534104024	TC00183-RI
955341040DX	0AD341041N; 95534104005	TC00182-RI
955341040JX	0AD341041M; 95534104055	TC00181-RI
955341040KX	0AD341041M; 95534104055	TC00181-RI
955341040LX	0AD341041N; 95534104005	TC00182-RI
955341040MX	0AD341041Q; 95534104024	TC00183-RI
95834101001	0C2341042K; 958341042D; 958341042DX	TC00299-RI
95834101002	0C2341042K; 958341042D; 958341042DX	TC00299-RI
95834101003	0C2341042K; 958341042D; 958341042DX	TC00299-RI
95834101004	0C2341042K; 958341042D; 958341042DX	TC00299-RI
95834101005	0C2341042K; 958341042D; 958341042DX	TC00299-RI
95834101006	0C2341042K; 958341042D; 958341042DX	TC00299-RI
95834101007	0C2341042K; 958341042D; 958341042DX	TC00299-RI
95834101008	0C2341042K; 958341042D; 958341042DX	TC00299-RI
95834101009	0C2341042K; 958341042D; 958341042DX	TC00299-RI
95834101010	0C2341042K; 958341042D; 958341042DX	TC00299-RI
95834101011	0C2341042L; 958341042E; 958341042EX	TC00300-RI
95834101012	0C2341042L; 958341042E; 958341042EX	TC00300-RI

All rights reserved.

This publication may not be reproduced in any form, in whole or in part, without a written approval from S-TEC Service Technologies GmbH & Co OG.  
Subject to change without notice!

**Brand - Series**

**Maingroup - Subgroup**

**Porsche - Cayenne**

**Gearbox, Powertrain - Transfer Case**

OEM no	Successor no	Part number
95834101013	0C2341042L; 958341042E; 958341042EX	TC00300-RI
95834101014	0C2341042L; 958341042E; 958341042EX	TC00300-RI
95834101015	0C2341042L; 958341042E; 958341042EX	TC00300-RI
95834101016	0C2341042L; 958341042E; 958341042EX	TC00300-RI
95834101017	0C2341042L; 958341042E; 958341042EX	TC00300-RI
95834101018	0C2341042L; 958341042E; 958341042EX	TC00300-RI
95834101019	0C2341042L; 958341042E; 958341042EX	TC00300-RI
95834101020	0C2341042M; 958341042F; 958341042FX	TC00301-RI
95834101021	0C2341042M; 958341042F; 958341042FX	TC00301-RI
95834101022	0C2341042M; 958341042F; 958341042FX	TC00301-RI
95834101023	0C2341042M; 958341042F; 958341042FX	TC00301-RI
95834101024	0C2341042M; 958341042F; 958341042FX	TC00301-RI
95834101025	0C2341042M; 958341042F; 958341042FX	TC00301-RI
95834101026	0C2341042M; 958341042F; 958341042FX	TC00301-RI
95834101027	0C2341042M; 958341042F; 958341042FX	TC00301-RI
95834101028	0C2341042M; 958341042F; 958341042FX	TC00301-RI
95834101029	0C2341042M; 958341042F; 958341042FX	TC00301-RI
95834101030	0C2341042N; 958341042G; 958341042GX	TC00467-RI
95834101031	0C2341042N; 958341042G; 958341042GX	TC00467-RI
95834101032	0C2341042N; 958341042G; 958341042GX	TC00467-RI
95834101033	0C2341042N; 958341042G; 958341042GX	TC00467-RI
95834101034	0C2341042N; 958341042G; 958341042GX	TC00467-RI
95834101035	0C2341042N; 958341042G; 958341042GX	TC00467-RI
95834101039	0C2341042L; 958341042E; 958341042EX	TC00300-RI
9583410103X	0C2341042M; 958341042F; 958341042FX	TC00301-RI
9583410104X	0C2341042M; 958341042F; 958341042FX	TC00301-RI
9583410105X	0C2341042M; 958341042F; 958341042FX	TC00301-RI
9583410106X	0C2341042N; 958341042G; 958341042GX	TC00467-RI

All rights reserved.

This publication may not be reproduced in any form, in whole or in part, without a written approval from S-TEC Service Technologies GmbH & Co OG.  
Subject to change without notice!

### Brand - Series

### Maingroup - Subgroup

### Porsche - Cayenne

### Gearbox, Powertrain - Transfer Case

OEM no	Successor no	Part number
9583410107X	0C2341042M; 958341042F; 958341042FX	TC00301-RI
9583410108X	0C2341042M; 958341042F; 958341042FX	TC00301-RI
9583410109X	0C2341042N; 958341042G; 958341042GX	TC00467-RI
958341010AX	0C2341042K; 958341042D; 958341042DX	TC00299-RI
958341010BX	0C2341042K; 958341042D; 958341042DX	TC00299-RI
958341010CX	0C2341042K; 958341042D; 958341042DX	TC00299-RI
958341010DX	0C2341042K; 958341042D; 958341042DX	TC00299-RI
958341010EX	0C2341042K; 958341042D; 958341042DX	TC00299-RI
958341010FX	0C2341042K; 958341042D; 958341042DX	TC00299-RI
958341010GX	0C2341042K; 958341042D; 958341042DX	TC00299-RI
958341010HX	0C2341042K; 958341042D; 958341042DX	TC00299-RI
958341010MX	0C2341042L; 958341042E; 958341042EX	TC00300-RI
958341010NX	0C2341042L; 958341042E; 958341042EX	TC00300-RI
958341010PX	0C2341042L; 958341042E; 958341042EX	TC00300-RI
958341010QX	0C2341042L; 958341042E; 958341042EX	TC00300-RI
958341010RX	0C2341042L; 958341042E; 958341042EX	TC00300-RI
958341010SX	0C2341042L; 958341042E; 958341042EX	TC00300-RI
958341011AX	0C2341042N; 958341042G; 958341042GX	TC00467-RI
958341011BX	0C2341042L; 958341042E; 958341042EX	TC00300-RI
958341011CX	0C2341042M; 958341042F; 958341042FX	TC00301-RI
958341011DX	0C2341042N; 958341042G; 958341042GX	TC00467-RI
958341011JX	0C2341042K; 958341042D; 958341042DX	TC00299-RI
958341011KX	0C2341042L; 958341042E; 958341042EX	TC00300-RI
958341011LX	0C2341042M; 958341042F; 958341042FX	TC00301-RI
958341011MX	0C2341042N; 958341042G; 958341042GX	TC00467-RI
958341011X	0C2341042M; 958341042F; 958341042FX	TC00301-RI
95834101200	0C2341042G; 958341042A; 958341042AX	TC00504-RI
95834101201	0C2341042G; 958341042A; 958341042AX	TC00504-RI

All rights reserved.

This publication may not be reproduced in any form, in whole or in part, without a written approval from S-TEC Service Technologies GmbH & Co OG.  
Subject to change without notice!

### Brand - Series

### Maingroup - Subgroup

### Porsche - Cayenne

### Gearbox, Powertrain - Transfer Case

OEM no	Successor no	Part number
95834101202	0C2341042G; 958341042A; 958341042AX	TC00504-RI
95834101204	0C2341042G; 958341042A; 958341042AX	TC00504-RI
95834101205	0C2341042G; 958341042A; 958341042AX	TC00504-RI
95834101210	0C2341042J; 958341042C; 958341042CX	TC00506-RI
95834101211	0C2341042J; 958341042C; 958341042CX	TC00506-RI
95834101212	0C2341042J; 958341042C; 958341042CX	TC00506-RI
95834101214	0C2341042J; 958341042C; 958341042CX	TC00506-RI
95834101215	0C2341042J; 958341042C; 958341042CX	TC00506-RI
95834101220	0C2341042F; 958341042; 958341042X	TC00505-RI
9583410122X	0C2341042F; 958341042; 958341042X	TC00505-RI
958341012AX	0C2341042G; 958341042A; 958341042AX	TC00504-RI
958341012EX	0C2341042G; 958341042A; 958341042AX	TC00504-RI
958341012KX	0C2341042J; 958341042C; 958341042CX	TC00506-RI
958341012LX	0C2341042J; 958341042C; 958341042CX	TC00506-RI
958341012MX	0C2341042J; 958341042C; 958341042CX	TC00506-RI
958341012PX	0C2341042J; 958341042C; 958341042CX	TC00506-RI
958341012QX	0C2341042J; 958341042C; 958341042CX	TC00506-RI
958341012X	0C2341042G; 958341042A; 958341042AX	TC00504-RI
95834101300	0C2341042F; 958341042; 958341042X	TC00505-RI
95834101301	0C2341042F; 958341042; 958341042X	TC00505-RI
95834101303	0C2341042F; 958341042; 958341042X	TC00505-RI
95834101304	0C2341042F; 958341042; 958341042X	TC00505-RI
95834101305	0C2341042H; 958341042B; 958341042BX	TC00507-RI
95834101306	0C2341042H; 958341042B; 958341042BX	TC00507-RI
95834101308	0C2341042H; 958341042B; 958341042BX	TC00507-RI
95834101309	0C2341042H; 958341042B; 958341042BX	TC00507-RI
958341013DX	0C2341042F; 958341042; 958341042X	TC00505-RI
958341013EX	0C2341042H; 958341042B; 958341042BX	TC00507-RI

All rights reserved.

This publication may not be reproduced in any form, in whole or in part, without a written approval from S-TEC Service Technologies GmbH & Co OG.  
Subject to change without notice!



### Brand - Series

### Maingroup - Subgroup

### Porsche - Cayenne

#### Gearbox, Powertrain - Transfer Case

OEM no	Successor no	Part number
958341013FX	0C2341042H; 958341042B; 958341042BX	TC00507-RI
958341013HX	0C2341042H; 958341042B; 958341042BX	TC00507-RI
958341013JX	0C2341042H; 958341042B; 958341042BX	TC00507-RI
958341013X	0C2341042F; 958341042; 958341042X	TC00505-RI
95834102001	0BU341011Q; 95834102003	TC00311-RI
95834102002	0BU341011Q; 95834102003	TC00311-RI
95834102003		TC00311-RI
95834102011	0BU341011M; 95834102012	TC00323-RI
95834102012		TC00323-RI
95834102020	0BU341011T; 95834102021	TC00319-RI
95834102021		TC00319-RI
9583410202X	0BU341011T; 95834102021	TC00319-RI
9583410203X	0BU341011T; 95834102021	TC00319-RI
958341020BX	0BU341011Q; 95834102003	TC00311-RI
958341020CX	0BU341011Q; 95834102003	TC00311-RI
958341020MX	0BU341011M; 95834102012	TC00323-RI
958341042		TC00505-RI
958341042A		TC00504-RI
958341042AX		TC00504-RI
958341042B		TC00507-RI
958341042BX		TC00507-RI
958341042C		TC00506-RI
958341042CX		TC00506-RI
958341042D		TC00299-RI
958341042DX		TC00299-RI
958341042E		TC00300-RI
958341042EX		TC00300-RI
958341042F		TC00301-RI
958341042FX		TC00301-RI
958341042G		TC00467-RI
958341042GX		TC00467-RI
958341042X		TC00505-RI

### Porsche - Macan

#### Gearbox, Powertrain - Transfer Case

OEM no	Successor no	Part number
95B341010	95B341010H	TC00494-RI
95B341010A	95B341010H	TC00494-RI
95B341010H		TC00494-RI
95B341010Q		TC00573-RI
95B341010QX		TC00573-RI

All rights reserved.

This publication may not be reproduced in any form, in whole or in part, without a written approval from S-TEC Service Technologies GmbH & Co OG.  
Subject to change without notice!

**Brand - Series****Maingroup - Subgroup****Porsche - Macan****Gearbox, Powertrain - Transfer Case**

OEM no	Successor no	Part number
95B341010R		TC00572-RI
95B341010RX		TC00572-RI
95B341010S		TC00571-RI
95B341010T		TC00570-RI
95B341010X	95B341010H	TC00494-RI

**Porsche - Panamera****Front Axle, Steering Unit - Front Differential**

OEM no	Successor no	Part number
97034901121	97034901123	FD00068-RI
97034901123		FD00068-RI

All rights reserved.

This publication may not be reproduced in any form, in whole or in part, without a written approval from S-TEC Service Technologies GmbH & Co OG.  
Subject to change without notice!

### Brand - Series

### Maingroup - Subgroup

### SEAT - Altea

#### Front Axle, Steering Unit - Power take off (PTO)

OEM no	Successor no	Part number
02M409053AQ	0AV409053AE	FD00052-RI
0AV409053AE		FD00052-RI
0AV409053H	0AV409053AE	FD00052-RI
0AV409053P	0AV409053AE	FD00052-RI
0AV409053S	0AV409053AE	FD00052-RI

#### Rear Axle - Rear Differential

OEM no	Successor no	Part number
0AV525010	0AV525010K	RD00022-RI
0AV525010A	0AV525010L	RD00023-RI
0AV525010B	0AV525010K	RD00022-RI
0AV525010C	0AV525010L	RD00023-RI
0AV525010D	0AV525010K	RD00022-RI
0AV525010E	0AV525010L	RD00023-RI
0AV525010H	0AV525010K	RD00022-RI
0AV525010K		RD00022-RI
0AV525010L		RD00023-RI
0BR525010	0BR525010G	RD00059-RI
0BR525010B	0BR525010G	RD00059-RI
0BR525010G		RD00059-RI

All rights reserved.

This publication may not be reproduced in any form, in whole or in part, without a written approval from S-TEC Service Technologies GmbH & Co OG.  
Subject to change without notice!

### Brand - Series

### Maingroup - Subgroup

### Skoda - Octavia

#### Front Axle, Steering Unit - Power take off (PTO)

OEM no	Successor no	Part number
02M409053AQ	0AV409053AE	FD00052-RI
0AV409053A	0AV409053K	FD00046-RI
0AV409053AE		FD00052-RI
0AV409053H	0AV409053AE	FD00052-RI
0AV409053K		FD00046-RI
0AV409053P	0AV409053AE	FD00052-RI
0AV409053S	0AV409053AE	FD00052-RI

#### Rear Axle - Rear Differential

OEM no	Successor no	Part number
0AV525010	0AV525010K	RD00022-RI
0AV525010B	0AV525010K	RD00022-RI
0AV525010D	0AV525010K	RD00022-RI
0AV525010H	0AV525010K	RD00022-RI
0AV525010K		RD00022-RI
0BR525010	0BR525010G	RD00059-RI
0BR525010B	0BR525010G	RD00059-RI
0BR525010G		RD00059-RI

### Skoda - Superb

#### Front Axle, Steering Unit - Power take off (PTO)

OEM no	Successor no	Part number
02M409053AQ	0AV409053AE	FD00052-RI
0AV409053AA	0AV409053AG	FD00054-RI
0AV409053AE		FD00052-RI
0AV409053AG		FD00054-RI
0AV409053H	0AV409053AE	FD00052-RI
0AV409053P	0AV409053AE	FD00052-RI
0AV409053R	0AV409053AG	FD00054-RI
0AV409053S	0AV409053AE	FD00052-RI

#### Rear Axle - Rear Differential

OEM no	Successor no	Part number
0BR525010	0BR525010G	RD00059-RI
0BR525010B	0BR525010G	RD00059-RI
0BR525010G		RD00059-RI

### Skoda - Yeti

#### Front Axle, Steering Unit - Power take off (PTO)

OEM no	Successor no	Part number
02M409053AQ	0AV409053AE	FD00052-RI
0AV409053AA	0AV409053AG	FD00054-RI
0AV409053AE		FD00052-RI
0AV409053AG		FD00054-RI
0AV409053H	0AV409053AE	FD00052-RI

All rights reserved.

This publication may not be reproduced in any form, in whole or in part, without a written approval from S-TEC Service Technologies GmbH & Co OG.  
Subject to change without notice!

# 4WD Systems References

## 2025



**Brand - Series**

**Maingroup - Subgroup**

**Skoda - Yeti**

**Front Axle, Steering Unit - Power take off (PTO)**

OEM no	Successor no	Part number
0AV409053P	0AV409053AE	FD00052-RI
0AV409053R	0AV409053AG	FD00054-RI
0AV409053S	0AV409053AE	FD00052-RI

**Rear Axle - Rear Differential**

OEM no	Successor no	Part number
0BR525010	0BR525010G	RD00059-RI
0BR525010B	0BR525010G	RD00059-RI
0BR525010E		RD00102-RI
0BR525010G		RD00059-RI
0BR525010J	0BR525010E	RD00102-RI

All rights reserved.

This publication may not be reproduced in any form, in whole or in part, without a written approval from S-TEC Service Technologies GmbH & Co OG.  
Subject to change without notice!

### Brand - Series

### Maingroup - Subgroup

### VW - Amarok

#### Gearbox, Powertrain - Transfer Case

OEM no	Successor no	Part number
0BU341010D	0BU341011N	TC00316-RI
0BU341010T	0BU341011N	TC00316-RI
0BU341011N		TC00316-RI

### VW - Atlas

#### Rear Axle - Rear Differential

OEM no	Successor no	Part number
0AY525010AE		RD00118-RI

### VW - Caddy

#### Front Axle, Steering Unit - Power take off (PTO)

OEM no	Successor no	Part number
02M409053AQ	0AV409053AE	FD00052-RI
0AV409053AE		FD00052-RI
0AV409053AF		FD00053-RI
0AV409053H	0AV409053AE	FD00052-RI
0AV409053J	0AV409053AF	FD00053-RI
0AV409053P	0AV409053AE	FD00052-RI
0AV409053Q	0AV409053AF	FD00053-RI
0AV409053S	0AV409053AE	FD00052-RI
0AV409053T	0AV409053AF	FD00053-RI

### VW - Golf

#### Front Axle, Steering Unit - Power take off (PTO)

OEM no	Successor no	Part number
02M409050X		FD00041-RI
02M409053AP		FD00041-RI
02M409053AQ	0AV409053AE	FD00052-RI
0AV409053A	0AV409053K	FD00046-RI
0AV409053AE		FD00052-RI
0AV409053AF		FD00053-RI
0AV409053H	0AV409053AE	FD00052-RI
0AV409053J	0AV409053AF	FD00053-RI
0AV409053K		FD00046-RI
0AV409053P	0AV409053AE	FD00052-RI
0AV409053Q	0AV409053AF	FD00053-RI
0AV409053S	0AV409053AE	FD00052-RI
0AV409053T	0AV409053AF	FD00053-RI

#### Rear Axle - Rear Differential

OEM no	Successor no	Part number
0AV525010	0AV525010K	RD00022-RI
0AV525010A	0AV525010L	RD00023-RI

All rights reserved.

This publication may not be reproduced in any form, in whole or in part, without a written approval from S-TEC Service Technologies GmbH & Co OG.  
Subject to change without notice!

### Brand - Series

### Maingroup - Subgroup

### VW - Golf

#### Rear Axle - Rear Differential

OEM no	Successor no	Part number
0AV525010B	0AV525010K	RD00022-RI
0AV525010C	0AV525010L	RD00023-RI
0AV525010D	0AV525010K	RD00022-RI
0AV525010E	0AV525010L	RD00023-RI
0AV525010H	0AV525010K	RD00022-RI
0AV525010K		RD00022-RI
0AV525010L		RD00023-RI
0BR525010	0BR525010G	RD00059-RI
0BR525010B	0BR525010G	RD00059-RI
0BR525010G		RD00059-RI

### VW - Passat

#### Front Axle, Steering Unit - Power take off (PTO)

OEM no	Successor no	Part number
02M409053AQ	0AV409053AE	FD00052-RI
0AU409053B	0AU409053T	FD00051-RI
0AU409053C	0AU409053T	FD00051-RI
0AU409053D	0AU409053T	FD00051-RI
0AU409053F	0AU409053T	FD00051-RI
0AU409053H	0AU409053T	FD00051-RI
0AU409053K	0AU409053T	FD00051-RI
0AU409053M	0AU409053T	FD00051-RI
0AU409053N	0AU409053T	FD00051-RI
0AU409053P	0AU409053T	FD00051-RI
0AU409053Q	0AU409053T	FD00051-RI
0AU409053S	0AU409053T	FD00051-RI
0AU409053T		FD00051-RI
0AV409053A	0AV409053K	FD00046-RI
0AV409053AE		FD00052-RI
0AV409053AF		FD00053-RI
0AV409053H	0AV409053AE	FD00052-RI
0AV409053J	0AV409053AF	FD00053-RI
0AV409053K		FD00046-RI
0AV409053P	0AV409053AE	FD00052-RI
0AV409053Q	0AV409053AF	FD00053-RI
0AV409053S	0AV409053AE	FD00052-RI
0AV409053T	0AV409053AF	FD00053-RI

#### Rear Axle - Rear Differential

OEM no	Successor no	Part number
01Z525010	01Z525010D	RD00040-RI
01Z525010B	01Z525010J	RD00042-RI
01Z525010C	01Z525010K	RD00043-RI
01Z525010D		RD00040-RI

All rights reserved.

This publication may not be reproduced in any form, in whole or in part, without a written approval from S-TEC Service Technologies GmbH & Co OG.  
Subject to change without notice!

### Brand - Series

### Maingroup - Subgroup

### VW - Passat

#### Rear Axle - Rear Differential

OEM no	Successor no	Part number
01Z525010F	01Z525010D	RD00040-RI
01Z525010G	01Z525010J	RD00042-RI
01Z525010H	01Z525010K	RD00043-RI
01Z525010J		RD00042-RI
01Z525010K		RD00043-RI
0AV525010	0AV525010K	RD00022-RI
0AV525010A	0AV525010L	RD00023-RI
0AV525010B	0AV525010K	RD00022-RI
0AV525010C	0AV525010L	RD00023-RI
0AV525010D	0AV525010K	RD00022-RI
0AV525010E	0AV525010L	RD00023-RI
0AV525010H	0AV525010K	RD00022-RI
0AV525010K		RD00022-RI
0AV525010L		RD00023-RI
0BS525010A	0BS525010G	RD00061-RI
0BS525010B	0BS525010G	RD00061-RI
0BS525010G		RD00061-RI

### VW - Sharan

#### Front Axle, Steering Unit - Power take off (PTO)

OEM no	Successor no	Part number
0A6409053AA	0A6409053AG	FD00049-RI
0A6409053AB	0A6409053AG	FD00049-RI
0A6409053AC	0A6409053AG	FD00049-RI
0A6409053AE	0A6409053AG	FD00049-RI
0A6409053AG		FD00049-RI
0A6409053AL	0A6409053AG	FD00049-RI
0A6409053B	0A6409053AG	FD00049-RI
0A6409053N	0A6409053AG	FD00049-RI
0A6409053Q	0A6409053AG	FD00049-RI
0A6409053T	0A6409053AG	FD00049-RI

#### Rear Axle - Rear Differential

OEM no	Successor no	Part number
0AY525010	0AY525010L	RD00058-RI
0AY525010B	0AY525010L	RD00058-RI
0AY525010C	0AY525010L	RD00058-RI
0AY525010D	0AY525010L	RD00058-RI
0AY525010F	0AY525010N	RD00100-RI
0AY525010L		RD00058-RI
0AY525010N		RD00100-RI
0BS525010D	0AY525010N	RD00100-RI

All rights reserved.

This publication may not be reproduced in any form, in whole or in part, without a written approval from S-TEC Service Technologies GmbH & Co OG.  
Subject to change without notice!



### Brand - Series

### Maingroup - Subgroup

### VW - Tiguan

#### Front Axle, Steering Unit - Power take off (PTO)

OEM no	Successor no	Part number
0A6409053AA	0A6409053AG	FD00049-RI
0A6409053AB	0A6409053AG	FD00049-RI
0A6409053AC	0A6409053AG	FD00049-RI
0A6409053AD	0A6409053AH	FD00060-RI
0A6409053AE	0A6409053AG	FD00049-RI
0A6409053AF	0A6409053AH	FD00060-RI
0A6409053AG		FD00049-RI
0A6409053AH		FD00060-RI
0A6409053AL	0A6409053AG	FD00049-RI
0A6409053AM	0A6409053AH	FD00060-RI
0A6409053B	0A6409053AG	FD00049-RI
0A6409053N	0A6409053AG	FD00049-RI
0A6409053Q	0A6409053AG	FD00049-RI
0A6409053S	0A6409053AH	FD00060-RI
0A6409053T	0A6409053AG	FD00049-RI
0AU409053B	0AU409053T	FD00051-RI
0AU409053C	0AU409053T	FD00051-RI
0AU409053D	0AU409053T	FD00051-RI
0AU409053F	0AU409053T	FD00051-RI
0AU409053H	0AU409053T	FD00051-RI
0AU409053K	0AU409053T	FD00051-RI
0AU409053M	0AU409053T	FD00051-RI
0AU409053N	0AU409053T	FD00051-RI
0AU409053P	0AU409053T	FD00051-RI
0AU409053Q	0AU409053T	FD00051-RI
0AU409053S	0AU409053T	FD00051-RI
0AU409053T		FD00051-RI

#### Rear Axle - Rear Differential

OEM no	Successor no	Part number
0AY525010	0AY525010L	RD00058-RI
0AY525010B	0AY525010L	RD00058-RI
0AY525010C	0AY525010L	RD00058-RI
0AY525010D	0AY525010L	RD00058-RI
0AY525010F	0AY525010N	RD00100-RI
0AY525010L		RD00058-RI
0AY525010N		RD00100-RI
0BS525010D	0AY525010N	RD00100-RI

### VW - Touareg

#### Gearbox, Powertrain - Transfer Case

OEM no	Successor no	Part number
0AD341010K	0AD341011L	TC00178-RI
0AD341010L	0AD341011N	TC00180-RI

All rights reserved.

This publication may not be reproduced in any form, in whole or in part, without a written approval from S-TEC Service Technologies GmbH & Co OG.  
Subject to change without notice!

### Brand - Series

### Maingroup - Subgroup

### VW - Touareg

### Gearbox, Powertrain - Transfer Case

OEM no	Successor no	Part number
0AD341010S	0AD341011L	TC00178-RI
0AD341011	0AD341011L	TC00178-RI
0AD341011C	0AD341011N	TC00180-RI
0AD341011CX	0AD341011N	TC00180-RI
0AD341011D	0AD341011N	TC00180-RI
0AD341011G	0AD341011L	TC00178-RI
0AD341011H	0AD341011L	TC00178-RI
0AD341011L		TC00178-RI
0AD341011LX	0AD341011L	TC00178-RI
0AD341011N		TC00180-RI
0AD341011NX	0AD341011N	TC00180-RI
0AD341012	0AD341011N	TC00180-RI
0AD341012A	0AD341011L	TC00178-RI
0AD341012D	0AD341011N	TC00180-RI
0AD341012E	0AD341011L	TC00178-RI
0AD341012F	0AD341011L	TC00178-RI
0AD341012J	0AD341011L	TC00178-RI
0AD341012K	0AD341011L	TC00178-RI
0AD341012KX	0AD341011L	TC00178-RI
0AD341012N	0AD341011N	TC00180-RI
0AD341012T	0AD341011L	TC00178-RI
0AD341012TX	0AD341011L	TC00178-RI
0BU341010B	0BU341011Q; 95834102003	TC00311-RI
0BU341010C	0BU341011R	TC00314-RI
0BU341010E	0BU341011F	TC00326-RI
0BU341010F	0BU341011S	TC00328-RI
0BU341010L	0BU341011T; 95834102021	TC00319-RI
0BU341010M	0BU341011M; 95834102012	TC00323-RI
0BU341010P		TC00304-RI
0BU341010R	0BU341011Q; 95834102003	TC00311-RI
0BU341010S	0BU341011R	TC00314-RI
0BU341011	0BU341011F	TC00326-RI
0BU341011A	0BU341011S	TC00328-RI
0BU341011B	0BU341011T; 95834102021	TC00319-RI
0BU341011C	0BU341011M; 95834102012	TC00323-RI
0BU341011D	0BU341011Q; 95834102003	TC00311-RI
0BU341011E	0BU341011F	TC00326-RI
0BU341011F		TC00326-RI
0BU341011G	0BU341011Q; 95834102003	TC00311-RI
0BU341011H	0BU341011R	TC00314-RI
0BU341011J	0BU341011T; 95834102021	TC00319-RI
0BU341011K	0BU341011M; 95834102012	TC00323-RI
0BU341011M		TC00323-RI
0BU341011P	0BU341011S	TC00328-RI

All rights reserved.

This publication may not be reproduced in any form, in whole or in part, without a written approval from S-TEC Service Technologies GmbH & Co OG.  
Subject to change without notice!

### Brand - Series

### Maingroup - Subgroup

### VW - Touareg

#### Gearbox, Powertrain - Transfer Case

OEM no	Successor no	Part number
0BU341011Q		TC00311-RI
0BU341011R		TC00314-RI
0BU341011S		TC00328-RI
0BU341011T		TC00319-RI
0BV341010K		TC00297-RI
95834102001	0BU341011Q; 95834102003	TC00311-RI
95834102002	0BU341011Q; 95834102003	TC00311-RI
95834102003		TC00311-RI
95834102011	0BU341011M; 95834102012	TC00323-RI
95834102012		TC00323-RI
95834102020	0BU341011T; 95834102021	TC00319-RI
95834102021		TC00319-RI
9583410202X	0BU341011T; 95834102021	TC00319-RI
9583410203X	0BU341011T; 95834102021	TC00319-RI
958341020BX	0BU341011Q; 95834102003	TC00311-RI
958341020CX	0BU341011Q; 95834102003	TC00311-RI
958341020MX	0BU341011M; 95834102012	TC00323-RI

### VW - Transporter

#### Front Axle, Steering Unit - Power take off (PTO)

OEM no	Successor no	Part number
09N409053	09N409053E	FD00058-RI
09N409053A	09N409053D	FD00059-RI
09N409053B	09N409053E	FD00058-RI
09N409053C	09N409053D	FD00059-RI
09N409053D		FD00059-RI
09N409053E		FD00058-RI

#### Rear Axle - Rear Differential

OEM no	Successor no	Part number
02W525010F	02W525010K	RD00062-RI
02W525010G	02W525010L	RD00063-RI
02W525010H	02W525010K	RD00062-RI
02W525010J	02W525010L	RD00063-RI
02W525010K		RD00062-RI
02W525010L		RD00063-RI
09N525010	09N525010C	RD00025-RI
09N525010A	09N525010E	RD00028-RI
09N525010B	09N525010E	RD00028-RI
09N525010C		RD00025-RI
09N525010E		RD00028-RI

All rights reserved.

This publication may not be reproduced in any form, in whole or in part, without a written approval from S-TEC Service Technologies GmbH & Co OG.  
Subject to change without notice!









**Service Technologies GmbH & Co OG**

Frank-Stronach-Straße 3  
8200 Albersdorf, Austria

T: +43 3112 9000-0

M: office@s-tec.at

[www.s-tec.at](http://www.s-tec.at)

